

CMT ORANGE TOOLS™

50
Anniversary



Catalog 2014/2015



Saw blades
Jig saw blades
Tools with bore & knives
Router bits & sets
CNC router cutters & chucks
Industrial dowel drills
Bits for hand power tools
Spare parts
Power tools & accessories
Display cabinets

WOOD
Magazine



CMT The Perfect 10!
Rated the #1 Overall Router Bits

Welcome to the 2014/2015 catalog

Dear customer,

Thank you for your interest in CMT products.

Browse our new catalog at your leisure and choose from a wider range of innovative and state-of-the-art woodworking tools, from router bits and sets, saw blades, CNC cutters, cutter heads, chucks, boring bits, power tools, and many more.

A detailed list of spare parts on each product category is also provided to guide you through your purchase.

We continually strive to develop our technical know-how and invest in research and development, but our priority is customer care.

A satisfied customer is worth more than any other achievements, therefore each page of this catalog contains CMT's highest dedication to the professional woodworker.

Should you not find a product that is fitting your needs, please let us know.

Our highly skilled engineers and operators are eager to design it for you to assist you with your woodworking operations.

Thank you for your interest in CMT Orange Tools.

Your CMT Team

Abbreviations

A	= Cutting angle
α	= Hook angle
ATB	= Alternate top bevel grind
B	= Bore diameter
β	= Type of grind
C	= Bearing diameter
COMBI3	= Pin-Hole 2/7/42 + 2/9/46,4 + 2/10/60
COMBI5	= Pin-Hole 2/7/110 + 2/8,4/130 + 2/14/110 + 4/9/100 + 4/19/120
COMBI7	= Pin-Hole 2/10/80 + 1/11/85 + 2/11/115 + 2/11/148 + 2/14/100 + 2/14/125 + 2/19/120
D	= Diameter
D₂	= Overall diameter
D₃	= For shank diameter
\emptyset	= Diameter
d	= Small cutting diameter
FFT	= Flat flat trapezoidal
FTG	= Flat top grind
FWF	= Flat with alternate chamfer
H	= Cutting depth
HDF	= Hollow ground teeth
l	= Cutting length
l₁	= Cutting length
l₂	= Cutting length
Inches	= Inches
K	= Kerf thickness
L	= Overall length
LB	= Adjusting length
LH	= Left-hand rotation
MATB	= Alternate top bevel with chamfer grind
MTCG	= Triple chip grind (trapezoidal) with chamfer
mm	= Millimeters
P	= Plate thickness
PTFE	= Non-stick industrial coating, black and orange
R	= Radius
R₁	= Radius
RH	= Right-hand rotation
RPM	= Round per minute
S	= Shank diameter
T₁	= Thickness / Maximum joint thickness
TCG	= Triple chip grind (trapezoidal)
V	= Spurs
Z	= Number of teeth
<input type="checkbox"/>	= On request
●	= Solid tungsten carbide



Saw blades

4 ~ 44

Saw blades



Jig saw blades

45 ~ 50

Jig saw blades



Tools with bore & knives

51 ~ 93

Tools with bore & Knives



Router bits & sets

94 ~ 188

Router bits & sets



CNC router cutters & chucks

189 ~ 224

CNC router cutter & chucks



Industrial dowel drills

225 ~ 250

Industrial dowel drills



Bits for hand power tools

251 ~ 268

Bits for hand power tools



Power tools & accessories

269 ~ 297

Power tools & accessories



Display cabinets & spare parts

298 ~ 306

Display cabinets & spare parts

SINCE 1962 - MADE IN ITALY THEN, STILL MADE IN ITALY TODAY

By now, the story has been told. After over 50 years of success and quality in manufacturing woodworking tools - orange woodworking tools, to be precise - word just sort of gets around. We have grown and we have changed, but one thing still remains the same: our commitment to making only the highest quality woodworking tools.



Pesaro, Italy



Greensboro, United States



Valencia, Spain

NEW! CMT Global Web Site!

- Full line catalogue available on line
- Instructional video on select products
- Instruction manuals available for download
- Listing of authorized CMT distributors
- Company history, tech information, testimonial and more!

CMT ORANGE TOOLS

THE ART OF CUTTING

Market Area: Where are you from? North America

Language: Choose favourite: English

News: New! Ref 2008 - August 20-23, 2008 Atlanta

OUR TOOLS So, what does it take to make a CMT tool? Like all things of quality, it's not only what you do but how you do it. And anyone who works wood knows that you get out of a piece only what you put into it, and it is no different when manufacturing a tool. You choose your designs and materials carefully and you work using all of your skill and know-how. You'll be happy to know that's what we do at CMT too.

DESIGN

Everything starts with a clear idea and having the potential to express it. We have both. At CMT, our technical department uses the best of both worlds - computer technology and hands-on experience - to engineer and design each tool so that it performs flawlessly each time you use it, and to guarantee that you'll be using it for a long, long time.

MATERIALS

Turning a design into a finished product means finding the right material that will do the job and that live up to the specifications set out in the design - quality performance from the final product depends on it. When it comes to selecting raw materials, we don't cut corners. At CMT, we know that high quality tools come only from high quality raw materials, so we use only solid bar stock steel and specially formulated micrograin carbide to manufacture our bits and blades.

MANUFACTURING

Like we said, it's not just what you do but how you do it. Over the years we have continuously invested in the latest technology in CNC machining equipment and innovative software to manufacture our tools. The result is that now our entire manufacturing process, from turning and milling the steel shanks to brazing and sharpening the carbide cutting tips, is completely automated. And since a machine is only as intelligent as the person using it, everything is operated by specifically trained operators.

THE FINAL TOUCH

A tool simply wouldn't be a CMT tool if it didn't have the trademark orange color non-stick PTFE coating on it. This unique industrial-strength surface coating is designed to withstand the physical stresses the tool undergoes during use while protecting it from residue build-up and burning. And we really like the orange color too.

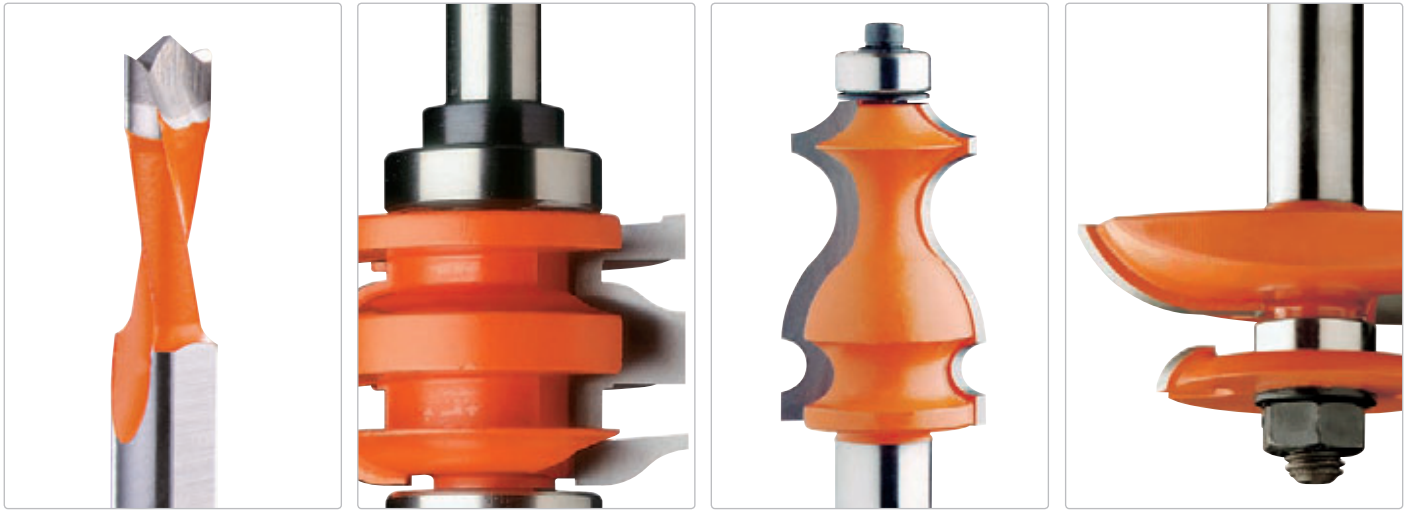

QUALITY CONTROL

Nobody's perfect, but we're trying. CMT uses rigorous quality control programs and equipment to ensure that each bit has been manufactured with precision and accuracy and that it will give the long-lasting performance you expect from a CMT orange tool. CMT is in the process of adopting the directives set out in ISO 9001 which will give SPC quality control by an independent party under the Common Market Directives ISO 9001. Quality control is the final step of the production process, but it's just as important as the first.

WE RECYCLE

The water used during production must be pure and free from contaminants or hard minerals like iron or calcium which can build up and damage the machinery. CMT filters and purifies its water using a reverse osmosis system located inside the plant. Also the oil used in grinding and machining our tools must be clean and absolutely free of contaminants. Clean oil, after enough use, gets dirty, so we filter and reprocess dirty oil on the premises. This is our way of guaranteeing the quality of the oil we use, as well as contributing to help protect the environment.

OUR TRADEMARK COLOR ORANGE

As the story goes, we began small. We also put orange color surface coating on our tools, then we put our tools on the market and soon our orange tools were all over the world. Now, any woodworker anywhere in the world can tell you that orange tools means CMT, and that CMT means quality. Here at CMT we know we produce quality. You should too. That's why we have trademarked the color orange on woodworking tools - it's your guarantee that you are getting a genuine high-quality CMT product.



Loading the automated multi-axis CNC sharpening machines.



Fully automated assembly and marking.

Saw blades

Jig saw blades

Tools with bore & Knives

Router bits & sets

CNC router cutter & chucks

Industrial dowel drills

Bits for hand power tools

Power tools & accessories

Display cabinets & spare parts





Saw blades

PRODUCTS	PAGE
Multi-rip saw blades	9 - 10
Building contractors saw blades	11
Universal saw blades	11 ~ 15
Saw blades for melamine and laminated	15 ~ 18
DP saw blades & scoring	19
Panel sizing saw blades	20
Scoring saw blades	21 - 22
Saw blades for aluminium and non-ferrous materials	22 - 23
Saw blades for metal and special materials	24 - 25
ITK Plus saw blades	26 ~ 28
Saw blades for portable machines	29 ~ 32
Grooving saw blades	33 - 34
Saw blade accessories	35
Portable machine index	36 - 37
Saw blade index	38 ~ 44

HOW WE PRODUCE OUR HIGH QUALITY BLADES

CMT stands for quality, which means we put quality into everything we do. It only makes sense. At CMT we figure that if our router bits are going to be top quality, high-performance and orange, then our saw blades should be too. And to do that, we simply follow the same guidelines for our blades that we do for our bits: start with a solid design, use only the best materials and manufacture with skill and care. And of course, make sure they are trademark orange.



DESIGN

The simplicity of a circular saw blade design is in reality a complexity of technical considerations. Each blade has to make a certain type of cut, and this requires careful analysis of hook and grind angles, gullet designs, to location of sound dampening slots and the thickness of the blade - just to name a few. So in order for us to get the best design for our blades - and for you to get the best performance from them - we use the same method that we use to engineer our router bits: we combine the knowledgeable minds and experience of our technical department and the latest computer technology. The result is a superior blade that has some rather special “standard” features:

Anti-vibration design. The anti-vibration cuts in the blade do exactly what their name implies: they are the anti in anti-vibration. This translates into less chattering during cutting and consequently it lengthens the life of the blade. Anti-vibration also means a flawless cut, so stabilizers and scoring blades are no longer necessary.

Expansion slots. These little hook-shaped cuts in the blade help to reduce noise while regulating the expansion and contraction of the blade as it generates heat during cutting operations.

MATERIALS

When it comes down to it, saw blades are much like router bits - it's just two components: steel and carbide. So in selecting the raw materials, we are every bit as picky with our saw blades as we are with our router bits. Besides, why mess with a winning formula like superior steel and tungsten carbide?

Steel. It's the heart of the blade, so CMT uses only the finest steel available: super 42-44 Rockwell hardness steel.

Carbide. The cutting tips of every CMT blade are made from the best grades of micrograin carbide.

MANUFACTURING

CMT saw blades are machined on automated CNC machines, from start to finish. The advanced technology and precision of these machines ensures uniform quality on every blade while giving us the possibility to carry out more efficient quality controls.

Laser cutting. The steel plate of the blade is laser cut, NEVER die cut, from superior strength steel. This way of cutting steel is not only extremely precise but it makes it possible to cut harder strengths of steel and does not stress the plate while cutting, so the resulting blade is flat and true and more resistant to warping.

Grinding and tensioning. After it has been cut, the blade is polished and tensioned, the evidence of which can be seen in the superior finish and a tension ring that are visible on the blade. Then the central bore is ground to a smooth finish so that the blade will fit precisely on the saw arbor and will have perfect concentricity during rotation. The seats for the carbide teeth are also ground, making sure that the carbide tips fit perfectly, providing the right conditions for making a secure braze.



Grinding and tensioning the blades.



Silver-copper-silver sandwich brazing. Once again, experience has been a good teacher. Automated brazing with a special silver-copper-silver “sandwich” brazing compound yields excellent results and reduces the chances of failed welds. In addition, this combination of metals is critical during brazing because as the steel body and the carbide tipped teeth are heated and cooled, they expand and contract at different rates. The copper layer acts as a buffer and keeps the carbide from cracking during cool down shrinkage. When woodworking, the copper provides flexibility and resistance to impact which in turn protects the carbide tips and steel shoulders when cutting through harder substances or knots in the wood.



Specially formulated carbide tips. What is true for router bit carbide tips is also true for the carbide tips on saw blades: what’s good for one type of blade may not be good for another. At CMT, we have studied carbide formulas and their impact on blade performance and have developed specially formulated carbide tips to match each blade’s application. Larger blades require an extra-fine harder carbide that holds its edge and resharpenes easily, while smaller blades need a special carbide that can withstand the occasional nail or imperfections that often occur in construction work. For each blade and each use, there is carbide made especially for it.



Sharpening and laser marking. The final step is sharpening the micrograin carbide teeth. During the sharpening phase, each angle is ground to razor-sharp precision - down to the Milacron - on multi-axis CNC machines. We also laser mark our blades so you have all the details about the blade type and its uses, right there on the blade.

















Sharpening the carbide tips.

Packaging and instructions. CMT blades are packed and protected for shipping, display and storage in either a sturdy cardboard box or in a patented heavy duty HDPE plastic case that’s as durable as our tools. Illustrated instructions for resharpening are included with your CMT blade so that you have all the details you need to keep the blade sharp, which will also help you extend the life of the blade.



CMT ORANGE TOOLS. Manufacturers of high quality woodworking tools since 1962, we are still proud to put “Made in Italy” on all our orange tools.

Maximize your saw's performance

BLADE'S RANGE	ORANGE CHROME	INDUSTRIAL / XTREME	ITK PLUS
PERFORMANCE	SUPERIOR ★★★★★	BEST ★★★★★	BETTER ★★★
DESCRIPTION	<p>Designed for professional woodworkers who require high precision and durability from their saw blades. Special chrome carbide reduces tooth abrasion, whereas the chrome plated body protects against rust, corrosion and guarantees long-lasting performance.</p> 	<p>Designed for fine woodworkers, finish carpenters, construction and industrial users who run their blades all day long demanding ultimate precision and extended life, while conquering the most challenging applications.</p> 	<p>Designed for the professional contractor and remodeler, CMT's ITK Plus delivers a clean, fast, effortless cut through wood and wood composite material. With a nice balance of features to price the ITK Plus line is a great value.</p> 
USER	Professional Woodworker	Professional	Contractor & Remodeler
USAGE	Run All Day	Run All Day	Daily Use
PRICE POINT	Premium	Premium	Mid
MATERIALS	Wood, plywood, OSB, laminate, melamine, mouldings, MDF.	Wood, Wood with nails, Plywood, OSB, Laminate, Melamine, MDF, Non-Ferrous, Metals, Stainless Steel, Plastics, Fiberglass, Solid Surface.	Wood, Composite Decking, Plywood, OSB, Laminate, Melamine, MDF, Fibercement.
STEEL PLATE	LASER-CUT PREMIUM QUALITY STEEL PLATE Made of 46-48 HRC precision German steel which is laser-cut to provide tighter tolerances ensuring longer life and more accurate cuts.	LASER-CUT PREMIUM QUALITY STEEL PLATE Made of 46-48 HRC precision German steel which is laser-cut to provide tighter tolerances ensuring longer life and more accurate cuts.	HEAVY-DUTY LASER-CUT PLATE Made of a thin & strong plate, laser cut from the finest steel which is then hardened to 44 HRC to ensure a longer life and more accurate cuts.
CARBIDE TEETH	 <p>INDUSTRIAL CHROMIUM MICROGRAIN CARBIDE Cutting teeth are made from a specially formulated chromium micrograin carbide which stays sharper longer by reducing cutting edge abrasion, improving cut quality and tool life.</p>	 <p>INDUSTRIAL CHROMIUM MICROGRAIN CARBIDE Special formulated chromium micrograin carbide which stays sharper longer by reducing cutting edge abrasion, improving cut quality and tool life.</p>	 <p>INDUSTRIAL SINTERHIP HI-DENSITY CARBIDE™ The new process SinterHIP (high temperature 1025°C and high pressure 105 bar) creates a porosity-free and Hi-Density carbide which provides a longer cutting life than tradition carbide.</p>
KERF	THICK	FULL KERF	THIN-KERF
BRAZING	 <p>TRI-METAL BRAZING The Silver-Copper-Silver tri-metal brazing process lets the teeth withstand the severe impact caused by cutting harder woods and composite material.</p>	 <p>TRI-METAL BRAZING The Silver-Copper-Silver tri-metal brazing process lets the teeth withstand the severe impact caused by cutting harder woods and composite material.</p>	<p>SILVER BRAZING The silver brazing process lets the teeth withstand the standard impact caused by cutting soft woods and composite material.</p>
COATING	 <p>CHROME COATING Blade plate is covered with a chrome layer to protect your tool against corrosion and rust, guaranteeing a longer tool life.</p>	<p>HARD LACQUER Protects against corrosion and rust.</p>	 <p>NON-STICK ORANGE SHIELD COATING Keeps the blade running cool, reduces pitch build up and protects against corrosion. Ideal for all types of wood including wet lumber.</p>
EXPANSION SLOTS	LASER-CUT HEAT EXPANSION SLOTS Are engineered to allow the blade to expand when heat build-up occurs from use, preventing blade warping.	LASER-CUT HEAT EXPANSION SLOTS Are engineered to allow the blade to expand when heat build-up occurs from use, preventing blade warping.	LASER-CUT HEAT EXPANSION SLOTS Are engineered to allow the blade to expand when heat build-up occurs from use, preventing blade warping.
SOUND DAMPENING CHANNELS	 <p>LASER-CUT SLOTS FILLED WITH SOUND-DAMPENING MATERIAL Slots are filled with polyurethane to reduce vibrations and noise (10% less than standard saw blades), improving cut quality and blade life.</p>	LASER-CUT SOUND-DAMPENING CHANNELS Are specifically designed to dampen running noise and control wobbling caused by unwanted harmonic vibration.	LASER-CUT SOUND-DAMPENING CHANNELS Are specifically designed to dampen running noise and control wobbling caused by unwanted harmonic vibration.
TENSIONING RINGS	TENSIONING RING A visible tension ring on the blade body provides stability during cut and perfect concentricity during rotation.	TENSIONING RING A visible tension ring on the blade body provides stability during cut and perfect concentricity during rotation.	✗
SHARPENING	 <p>PRECISION MIRROR FINISH SHARPENING Each tooth is ground to razor sharp precision on a multi-axis CNC machine which creates the perfect edge angles, guaranteeing extra-clean cuts and extended life. Featuring less than 0.25 µm Rmax in edge roughness.</p>	 <p>PRECISION MIRROR FINISH SHARPENING Each tooth is ground to razor sharp precision on a multi-axis CNC machine which creates the perfect edge angles, guaranteeing extra-clean cuts and extended life. Featuring less than 0.25 µm Rmax in edge roughness.</p>	 <p>SHEAR ANGLE SHARPENING The shear angle grind on the teeth's front face produces smooth cuts, while reducing the cutting force needed and improving cutting speed, setting a new standard for performance.</p>



279



APPLICATION: for rip cuts where the rakers prevent the wood contact with the steel plate.
MACHINES: multi-rip machines with one or two shafts.
MATERIAL: wet or dry soft and hardwood.

	ISO:	K20
	HV10:	1.640
	N/mm ² :	2.200

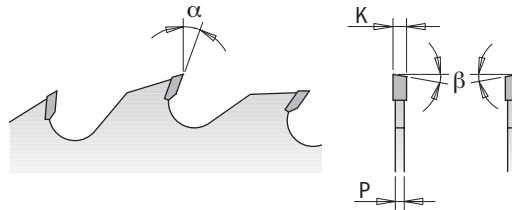

EXCELLENT Multiple rip wood

D mm	B mm	Pin Hole	Key way mm	Z	K mm	P mm	α	β	ORDER NO.
250	30	COMBI3		20+4	3,2	2,2	18°	10° ATB	279.020.10M
250	70		21 x 5	20+4	3,2	2,2	18°	10° ATB	279.020.10V
250	80		13 x 5	20+4	3,2	2,2	18°	10° ATB	279.020.10W
300	30	COMBI3		24+4	3,2	2,2	18°	10° ATB	279.024.12M
300	60		21 x 5	24+4	3,2	2,2	18°	10° ATB	279.024.12U
300	70		21 x 5	24+4	3,2	2,2	18°	10° ATB	279.024.12V
300	80		13 x 5	24+4	3,2	2,2	18°	10° ATB	279.024.12W
350	30	COMBI3		28+4	3,5	2,5	18°	10° ATB	279.028.14M
350	60		21 x 5	28+4	3,5	2,5	18°	10° ATB	279.028.14U
350	70		21 x 5	28+4	3,5	2,5	18°	10° ATB	279.028.14V
350	80		14 x 5	28+4	3,5	2,5	18°	10° ATB	279.028.14W
400	30	COMBI3		28+6	4,0	2,8	18°	10° ATB	279.028.16M
400	70		21 x 5	28+6	4,0	2,8	18°	10° ATB	279.028.16V

Multi-rip anti-kickback saw blades *industrial line*



278



APPLICATION: for rip cuts where the special steel plate prevents vibrations during work
MACHINES: multi-rip machines with one or two shafts.
MATERIAL: dry soft and hardwood.

	ISO:	K20
	HV10:	1.640
	N/mm ² :	2.200

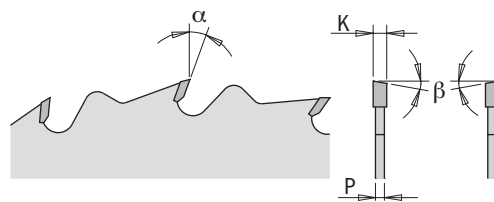

EXCELLENT Multiple rip wood

D mm	B mm	Pin Hole	Key way mm	Z	K mm	P mm	α	β	ORDER NO.
300	30	COMBI3		28	3,2	2,2	18°	10° ATB	278.028.12M
300	70		21 x 5	28	3,2	2,2	18°	10° ATB	278.028.12V
350	30	COMBI3		36	3,5	2,5	18°	10° ATB	278.036.14M
350	70		21 x 5	36	3,5	2,5	18°	10° ATB	278.036.14V

Thin-kerf multi-rip saw blades with rakers *industrial line***280****APPLICATION:** for rip cuts where the thin-kerf reduces material wastes.**MACHINES:** multi-rip machines with one or two shafts.**MATERIAL:** wet or dry hardwood.

	ISO:	K20
	HV10:	1.640
	N/mm ² :	2.200

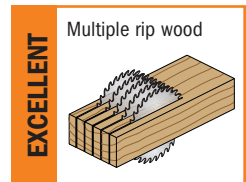
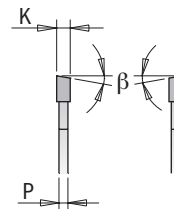
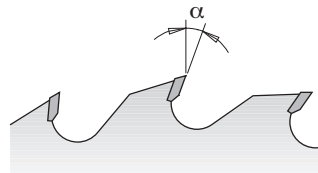

D mm	B mm	Key way mm	Z	K mm	P mm	α	β	ORDER NO.
180	40		21+3	2,5	1,8	18°	FLAT	280.021.07S
200	40		21+3	2,5	1,8	18°	FLAT	280.021.08S
250	70	21 x 5	20+4	2,7	1,8	18°	10° ATB	280.020.10V
250	80	13 x 5	20+4	2,7	1,8	18°	10° ATB	280.020.10W
300	70	21 x 5	24+4	2,7	1,8	18°	10° ATB	280.024.12V
300	80	13 x 5	24+4	2,7	1,8	18°	10° ATB	280.024.12W

Thick-kerf multi-rip saw blades with rakers *industrial line***277****APPLICATION:** for rip cuts. Mounted on the sides of gang rip saws, these act as shoulder saw blades and help ensure stability and reduce vibrations under extreme work load.**MACHINES:** multi-rip machines with one or two shafts.**MATERIAL:** thick wet or dry hardwood.

	ISO:	K20
	HV10:	1.640
	N/mm ² :	2.200

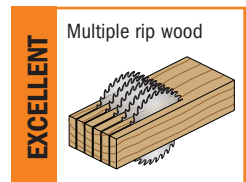
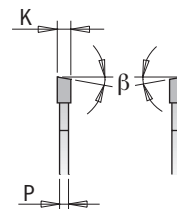
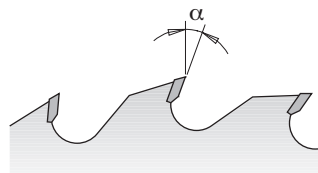

D mm	B mm	Key way mm	Z	K mm	P mm	α	β	ORDER NO.
300	30		24+4	4,0	2,8	18°	10° ATB	277.024.12M
300	70	21 x 5	24+4	4,0	2,8	18°	10° ATB	277.024.12V
300	80	13 x 5	24+4	4,0	2,8	18°	10° ATB	277.024.12W
350	30		24+6	4,2	2,8	18°	10° ATB	277.024.14M
350	70	21 x 5	24+6	4,2	2,8	18°	10° ATB	277.024.14V



286

APPLICATION: for rip and crosscuts especially designed for building contractors.
MACHINES: table saws and portable machines.
MATERIAL: soft and hardwood and panels with nails, metal clips and pieces of concrete.



	ISO:	K20
	HV10:	1.550
	N/mm ² :	2.600

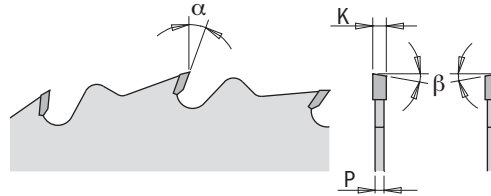

EXCELLENT Soft wood with nails, screw, concrete, etc.

D mm	B mm	Pin Hole 	Z	K mm	P mm	α	β	ORDER NO.
250	30	COMBI3	16	2,8	1,8	15°	5° ATB	286.016.10M
300	30	COMBI3	20	2,8	1,8	15°	5° ATB	286.020.12M
315	30	COMBI3	24	3,2	2,2	15°	5° ATB	286.024.13M
350	30	COMBI3	24	3,2	2,2	15°	5° ATB	286.024.14M
400	30	COMBI3	28	3,2	2,2	15°	5° ATB	286.028.16M
450	30	2/10/60	32	3,8	2,8	15°	5° ATB	286.032.18M
500	30	2/10/60	36	3,8	2,8	15°	5° ATB	286.036.20M
550	30	2/10/60	40	4,2	3,2	15°	5° ATB	286.040.22M
600	30	2/10/60	40	4,2	3,2	15°	5° ATB	286.040.24M
<small>new</small> 700	30	2/10/60	46	4,4	3,2	15°	5° ATB	286.046.28M

Shop tips: Use our reduction ring from 30 to 25mm order n. 299.225.00 (for rip saw blades Ø250-300-315)
 Use our reduction ring from 30 to 25mm order n. 299.228.00 (for rip saw blades Ø350 and larger)

Rip saw blades *industrial line*



285-290-293

APPLICATION: for rip and glue line rip cuts.
MACHINES: table and special saws, portable and ripping machines for automatic or manual feeding.
MATERIAL: soft and hardwood.



	ISO:	K10
	HV10:	1.765
	N/mm ² :	2.150

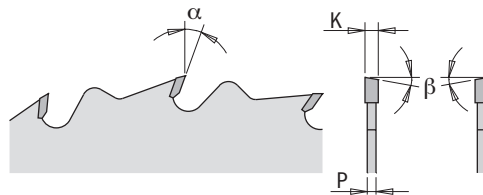

EXCELLENT Rip wood

D mm	B mm	Pin Hole 	Z	K mm	P mm	α	β	ORDER NO.
250*	30	COMBI3	24	2,8	1,8	20°	10° ATB	290.250.24M
270*	30	2/7/42	28	2,8	1,8	20°	10° ATB	290.270.28M
300	30	COMBI3	24	3,2	2,2	20°	10° ATB	293.024.12M
300	35		24	3,2	2,2	20°	10° ATB	293.024.12R
305	30	2/10/60	28	2,8	1,8	20°	10° ATB	293.028.22M
315*	30	COMBI3	28	3,2	2,2	20°	10° ATB	293.028.12M
315*	30	2/10/60 + 2/7/42	36	3,2	1,8	15°	5° ATB	285.036.13M
350	30	COMBI3	28	3,5	2,5	20°	10° ATB	293.028.14M
350	35		28	3,5	2,5	20°	10° ATB	293.028.14R
400	30	COMBI3	36	3,5	2,5	20°	10° ATB	285.036.16M
450	30	2/10/60	36	3,8	2,8	20°	10° ATB	285.036.18M
500	30	COMBI3	44	4,0	2,8	20°	10° ATB	285.044.20M

*Non-low noise



285-291-294

APPLICATION: for optimal quality rip and crosscuts.

MACHINES: table and special saws, portable machines.

MATERIAL: soft and hardwood, wood-based panels.

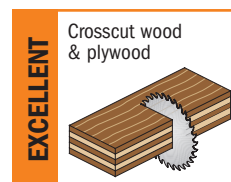
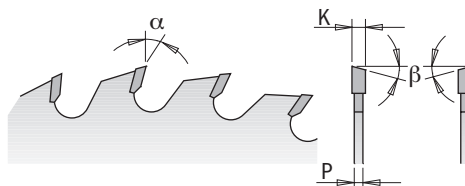
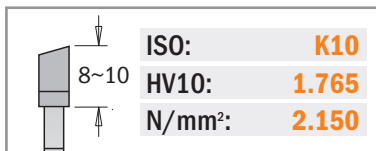

D mm	B mm	Pin Hole 	Z	K mm	P mm	α	β	ORDER NO.
200	30	2/10/60 + 2/7/42	36	3,2	2,2	15°	10° ATB	285.036.08M
200	30	2/10/60 + 2/7/42	48	3,2	2,2	15°	15° ATB	285.048.08M
250*	20	COMBI3	40	3,2	2,2	15°	10° ATB	285.040.10H
250	30	COMBI3	40	3,2	2,2	15°	10° ATB	285.040.10M
250	30	COMBI3	48	3,2	2,2	15°	10° ATB	285.048.10M
250	30	COMBI3	60	3,2	2,2	10°	15° ATB	285.060.10M
250	35		40	3,2	2,2	15°	10° ATB	285.040.10R
250	35		60	3,2	2,2	10°	15° ATB	285.060.10R
254	30	COMBI3	48	2,4	1,8	- 5° Neg.	15° ATB	294.048.10M
254	30	COMBI3	60	2,4	1,8	- 5° Neg.	15° ATB	294.060.10M
260	30	2/10/60 + 2/7/42	48	2,8	1,8	15°	10° ATB	285.048.11M
260	30	2/10/60 + 2/7/42	60	2,8	1,8	10°	15° ATB	285.060.11M
260	30	COMBI3	60	2,5	1,8	- 5° Neg.	15° ATB	294.060.11M
270*	30	2/7/42	42	2,8	1,8	15°	15° ATB	291.270.42M
275	20		42	3,2	2,2	15°	10° ATB	285.042.11H
280*	30	2/10/60 + 2/7/42	64	2,8	1,8	10°	15° ATB	295.064.11M
300*	20	COMBI3	48	3,2	2,2	15°	10° ATB	285.048.12H
300	30	COMBI3	36	3,2	2,2	15°	10° ATB	285.036.12M
300	30	COMBI3	48	3,2	2,2	15°	10° ATB	285.048.12M
300	30	COMBI3	60	3,2	2,2	15°	10° ATB	285.060.12M
300	30	COMBI3	72	3,2	2,2	10°	15° ATB	285.072.12M
300	35		48	3,2	2,2	15°	10° ATB	285.048.12R
300	35		72	3,2	2,2	10°	15° ATB	285.072.12R
305*	30	2/10/60 + 2/7/42	54	2,8	1,8	-5° Neg.	15° ATB	294.054.22M
315*	30	COMBI3	54	3,2	2,2	15°	10° ATB	294.054.12M
350	30	COMBI3	54	3,5	2,5	15°	10° ATB	285.054.14M
350	30	COMBI3	72	3,5	2,5	15°	10° ATB	285.072.14M
350	30	COMBI3	84	3,5	2,5	10°	15° ATB	285.084.14M
350	35		54	3,5	2,5	15°	10° ATB	285.054.14R
350	35		84	3,5	2,5	10°	15° ATB	285.084.14R
400	30	COMBI3	48	3,5	2,5	20°	10° ATB	285.048.16M
400	30	COMBI3	60	3,5	2,5	10°	15° ATB	285.060.16M
450	30	2/10/60	54	3,8	2,8	15°	15° ATB	285.054.18M
450	30	2/10/60	66	3,8	2,8	10°	15° ATB	285.066.18M
500	30	2/10/60	60	3,8	2,8	15°	15° ATB	285.060.20M
500	30	2/10/60	72	3,8	2,8	10°	15° ATB	285.072.20M
550	30	2/10/60	60	4,2	3,2	10°	15° ATB	285.060.22M
550	30	2/10/60	96	4,2	3,2	10°	15° ATB	285.096.22M
600	30	2/10/60	66	4,2	3,2	10°	15° ATB	285.066.24M
700	30	2/10/60	72	4,4	3,2	10°	15° ATB	285.072.28M

*Non-low noise



285-294

APPLICATION: for optimal quality crosscuts.
MACHINES: table and sizing saws, portable machines.
MATERIAL: soft, hard and exotic wood, wood-based panels.

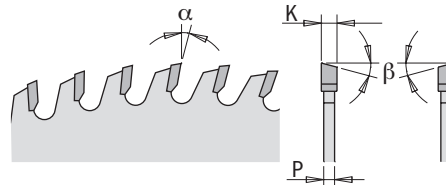
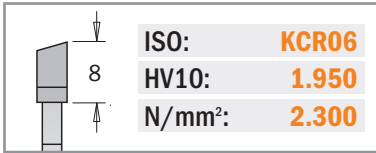
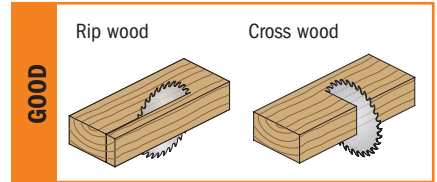
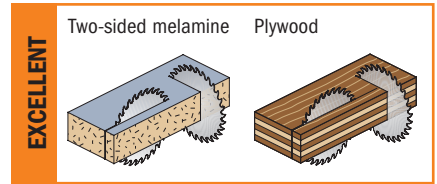

D	B	Pin Hole	Z	K	P	α	β	ORDER NO.
mm	mm			mm	mm			
150	30	2/7/42	48	3,2	2,2	5°	15° ATB	285.048.06M
160	20	2/6/32	48	2,2	1,6	5°	15° ATB	285.160.48H
180	30	2/7/42	56	3,2	2,2	5°	15° ATB	285.056.07M
200	30	2/10/60 + 2/7/42	64	3,2	2,2	5°	15° ATB	285.064.08M
250	30	COMBI3	80	3,2	2,2	5°	15° ATB	285.080.10M
250	35		80	3,2	2,2	5°	15° ATB	285.080.10R
300	30	COMBI3	96	3,2	2,2	5°	15° ATB	285.096.12M
300	35		96	3,2	2,2	5°	15° ATB	285.096.12R
305	30	COMBI3	72	3,2	2,2	10°	15° ATB	285.072.22M
305	30	COMBI3	72	3,2	2,2	-5° Neg.	15° ATB	294.072.22M
315	30	2/10/60 + 2/7/42	72	3,2	2,2	10°	15° ATB	285.072.13M
350	30	COMBI3	108	3,5	2,5	5°	15° ATB	285.108.14M
350	35		108	3,5	2,5	5°	15° ATB	285.108.14R
400	30	COMBI3	96	3,5	2,5	10°	15° ATB	285.096.16M
400	30	2/10/60 + 2/7/42	120	3,5	2,5	10°	15° ATB	285.120.16M

Super finishing saw blades for cutting frames *XTreme line*

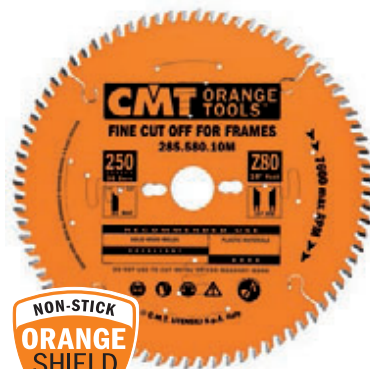

285.5 XTREME

APPLICATION: for optimal quality crosscuts on moulds and end trimming for perfect joints.
MACHINES: table and sizing saws, single or double mitre saws.
MATERIAL: soft and hardwood, MDF.

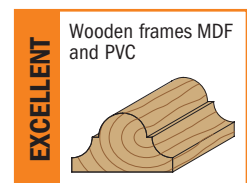
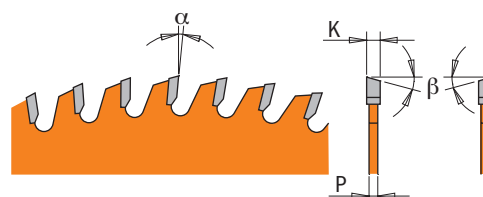
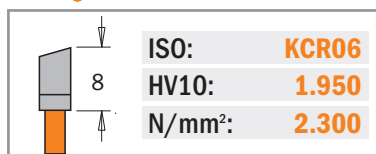
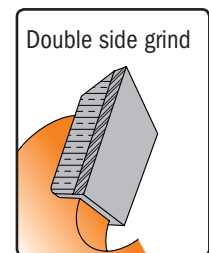

D	B	Pin Hole	Z	K	P	α	β	ORDER NO.
mm	mm			mm	mm			
250	30	COMBI3	80	3,0	2,5	10°	20° ATB	285.580.10M
300	30	COMBI3	96	3,0	2,5	10°	20° ATB	285.596.12M

Orange PTFE coated blades: a great choice for the shop that keeps its blades running all day, every day. With their heavy-gauge plate, these blades have the stamina for saws with lots of power.

Low noise & Chrome coated saw blades with ATB grind



285 ORANGE CHROME™

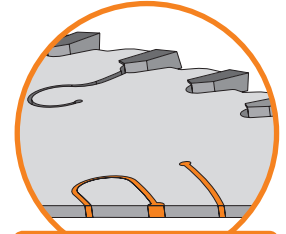
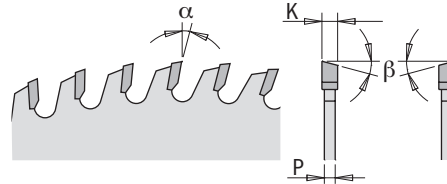

FILLED SLOTS

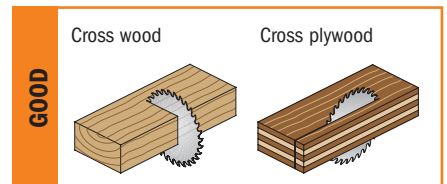
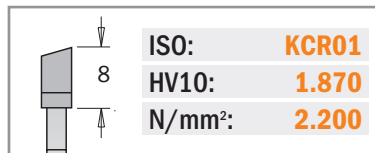
APPLICATION: for optimal quality rip and crosscuts.**MACHINES:** table and special saws, portable machines.**MATERIAL:** soft and hardwood, wood-based panels.

D mm	B mm	Pin Hole 	Z	K mm	P mm	α	β	ORDER NO.
250	30	COMBI3	40	3,2	2,2	15°	10° ATB	285.640.10M
300	30	COMBI3	48	3,2	2,2	15°	10° ATB	285.648.12M
350	30	COMBI3	54	3,5	2,5	15°	10° ATB	285.654.14M

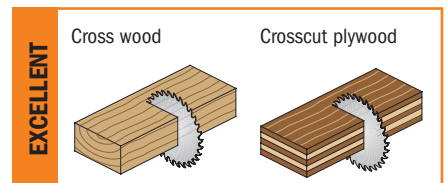
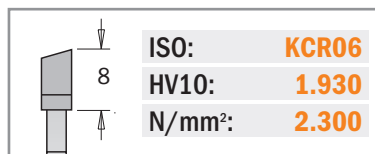
APPLICATION: for optimal quality crosscuts.**MACHINES:** table and sizing saws, portable machines.**MATERIAL:** soft, hard and exotic wood, wood-based panels.

D mm	B mm	Pin Hole 	Z	K mm	P mm	α	β	ORDER NO.
250	30	COMBI3	60	3,2	2,2	10°	15° ATB	285.660.10M
300	30	COMBI3	72	3,2	2,2	10°	15° ATB	285.672.12M
350	30	COMBI3	84	3,5	2,5	10°	15° ATB	285.684.14M

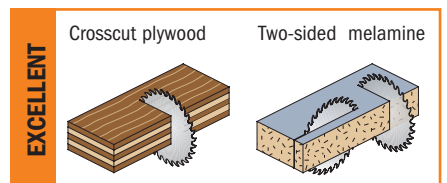
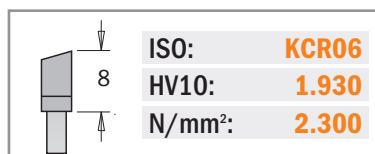
APPLICATION: for high-quality cross cutting.**MACHINES:** table and sizing saws, portable machines.**MATERIAL:** soft, hard and exotic wood, wood-based panels, one-side veneered, paper-base laminate and thermoplastic material.

D mm	B mm	Pin Hole 	Z	K mm	P mm	α	β	ORDER NO.
250	30	COMBI3	80	3,2	2,2	5°	15° ATB	285.680.10M
300	30	COMBI3	96	3,2	2,2	5°	15° ATB	285.696.12M
350	30	COMBI3	108	3,5	2,5	5°	15° ATB	285.708.14M



274 XTREME



APPLICATION: for high-quality cross cutting.
MACHINES: table and sizing saws, portable machines.
MATERIAL: soft, hard and exotic wood, wood-based panels, one-side veneered, paper-base laminate and thermoplastic material.

ISO:	KCR06
HV10:	1.950
N/mm ² :	2.300

Max run out tolerance 0,05mm

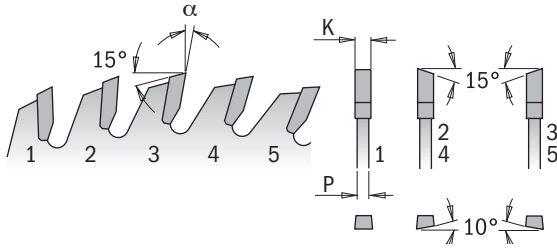

EXCELLENT

Two-sided melamine	Plywood	Molduras y PVC	For all non-ferrous metals and PVC
--------------------	---------	----------------	------------------------------------

D mm	B mm	Pin Hole	Z	K mm	P mm	α	β	ORDER NO.
250	30	COMBI3	80	3,2	2,2	15°	1FTG+4ATB	274.080.10M
300	30	COMBI3	100	3,2	2,2	15°	1FTG+4ATB	274.100.12M

Fine cut-off saw blades for two-sided melamine *industrial line*



287



APPLICATION: for sizing cuts, perfect finish with high feed rate and long tool life without using scoring blade.
MACHINES: single or double-sided laminated panels with hard coating and veneered.
MATERIAL: one-side or double side laminated and hard coating panels, thermoplastic.

ISO:	KCR06
HV10:	1.950
N/mm ² :	2.300

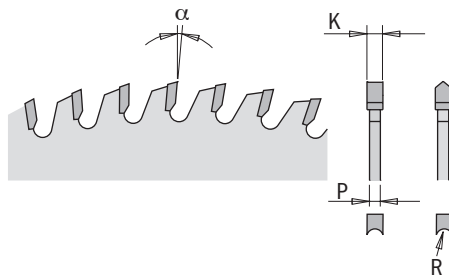
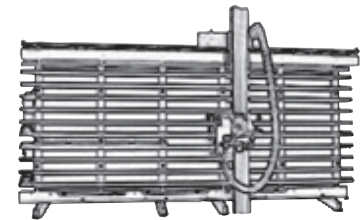

EXCELLENT

Cross wood	Crosscut plywood	Two-sided melamine
------------	------------------	--------------------

D mm	B mm	Pin Hole	Z	K mm	P mm	α	β	ORDER NO.
Positive hook angle								
160	20	2/6/32	34	2,6	1,8	10°	HDF	287.034.06H
220	30	2/7/42	42	3,2	2,2	10°	HDF	287.042.09M
250	30	COMBI3	48	3,2	2,2	10°	HDF	287.048.10M
303	30	COMBI3	60	3,2	2,2	10°	HDF	287.060.12M
Negative hook angle								
220	30	2/7/42	42	3,2	2,2	-6°	HDF	287.043.09M
250	30	COMBI3	48	3,2	2,2	-6°	HDF	287.049.10M
303	30	COMBI3	60	3,2	2,2	-6°	HDF	287.061.12M

Fine cut-off saw blades for two-sided melamine *industrial line*



283

APPLICATION: for sizing cuts, perfect finishing on both sides of double-sided panels without using scoring blades.

MACHINES: table and vertical saws, sizing and portable machines.

MATERIAL: single or double-sided laminated panels with coating and veneered.

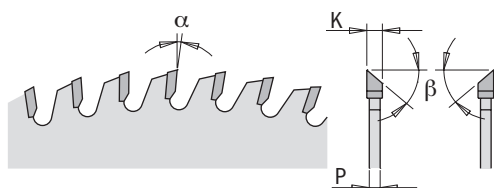
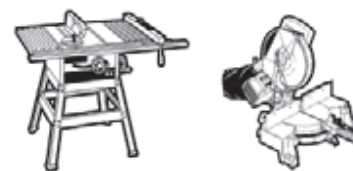
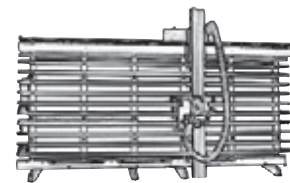
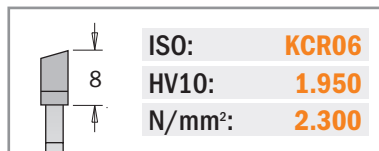
EXCELLENT

Cross wood

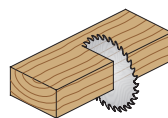

Crosscut plywood

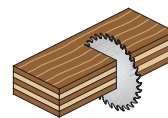

Two-sided melamine

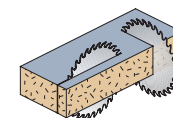

D mm	B mm	Pin Hole 	Z	K mm	P mm	α	β	ORDER NO.
220*	30	2/7/42	64	3,2	2,2	-5°	40° ATB	283.064.09M
250	30	COMBI3	80	3,2	2,2	-2°	40° ATB	283.080.10M
300	30	COMBI3	96	3,2	2,2	2°	40° ATB	283.096.12M
350	30	COMBI3	108	3,5	2,5	5°	40° ATB	283.108.14M

*Non-low noise

Fine cut-off saw blades for melamine two-sided *XTreme line*



210 XTREME

APPLICATION: for sizing cuts, perfect finishing on both sides on bilaminated panels without using scoring blade.

MACHINES: table and vertical saws, sizing and portable machines.

MATERIAL: one-side or double-sided laminated panels with coating and veneered.

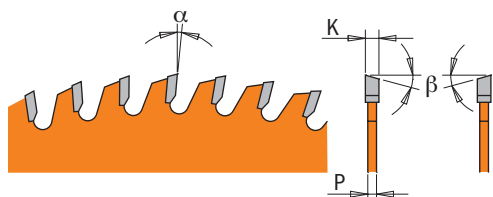
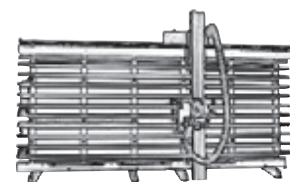
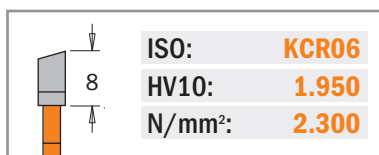
EXCELLENT

Cross wood

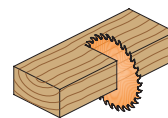

Plywood

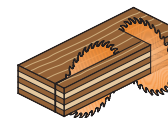

Two-sided melamine

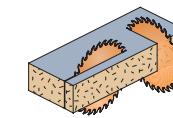

D mm	B mm	Z	K mm	P mm	α	β	ORDER NO.
250	30	80	3,2	2,2	5°	40° ATB	210.080.10M
300	30	96	3,2	2,2	5°	40° ATB	210.096.12M

Orange PTFE coated blades: a great choice for the shop that keeps its blades running all day, every day. With their heavy-gauge plate, these blades have the stamina for saws with lots of power.

Low noise & Chrome coated saw blades with TCG grind



281 ORANGE CHROME™



APPLICATION: for sizing cuts, perfect finishing by using scoring blades.
MACHINES: table saws, horizontal and vertical sizing machines.
MATERIAL: single or double-sided plastic-laminated panels.

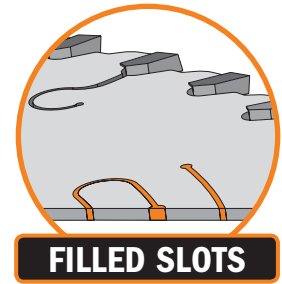

ISO:	KCR05
HV10:	2.150
N/mm²:	2.500

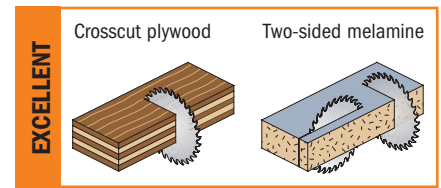
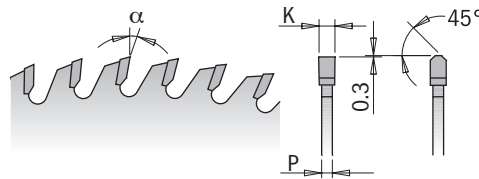

D mm	B mm	Pin Hole	Z	K mm	P mm	α	β	ORDER NO.
250	30	COMBI3	80	3,2	2,2	5°	TCG	281.680.10M
300	30	COMBI3	72	3,2	2,2	10°	TCG	281.672.12M
300	30	COMBI3	96	3,2	2,2	5°	TCG	281.696.12M
350	30	COMBI3	108	3,5	2,5	5°	TCG	281.708.14M

Melamine and laminated long-lasting saw blades xTreme line



295 xTreme



APPLICATION: for sizing cuts, perfect finishing without using scoring blade.
MACHINES: table saws, horizontal and vertical sizing machines.
MATERIAL: double-sided laminated panels.

ISO:	KCR05
HV10:	2.150
N/mm²:	2.500

Max run out tolerance 0,05mm

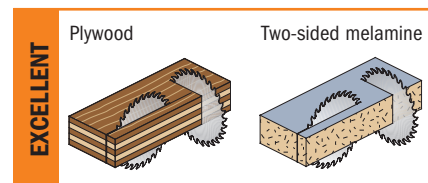
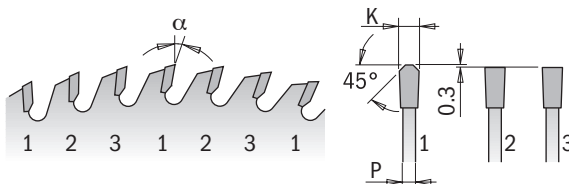
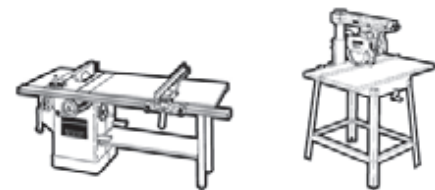

D mm	B mm	Pin Hole	Z	K mm	P mm	α	β	ORDER NO.
250	30	COMBI3	78	3,2	2,2	10°	FFT	295.078.10M
300	30	COMBI3	96	3,2	2,2	10°	FFT	295.096.12M
350	30	COMBI3	108	3,5	2,5	10°	FFT	295.108.14M

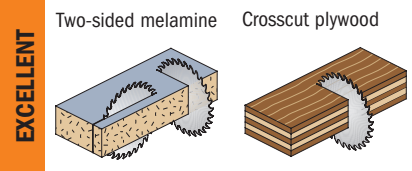
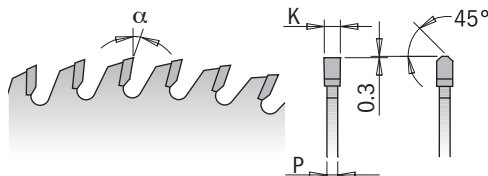
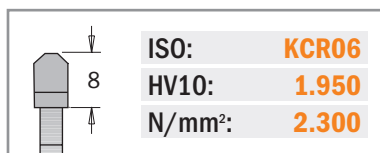
Laminated and chipboard saw blades *industrial line***281****APPLICATION:** for sizing cuts, perfect finishing by using scoring blades.**MACHINES:** table saws, horizontal and vertical sizing machines.**MATERIAL:** single or double-sided plastic-laminated panels.

D mm	B mm	Pin Hole 	Z	K mm	P mm	α	β	ORDER NO.
160	20 (Virutex)	4/7/32 45°	40	2,2	1,6	10°	TCG	281.160.40H
160*	20	2/6/32	40	2,2	1,6	10°	TCG	281.160.40H2
200*	30	2/7/42	64	3,2	2,2	10°	TCG	281.064.08M
220*	30	2/7/42	64	3,2	2,2	10°	TCG	281.064.09M
250	30	COMBI3	60	3,2	2,2	10°	TCG	281.060.10M
250	30	COMBI3	80	3,2	2,2	10°	TCG	281.080.10M
300	30	COMBI3	72	3,2	2,2	10°	TCG	281.072.12M
300	30	COMBI3	96	3,2	2,2	10°	TCG	281.096.12M
350	30	COMBI3	84	3,5	2,5	10°	TCG	281.084.14M
350	30	COMBI3	108	3,5	2,5	10°	TCG	281.108.14M

*Non-low noise

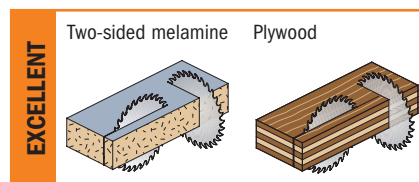
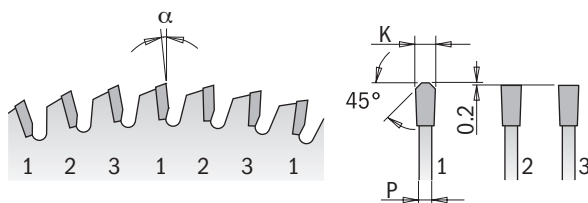
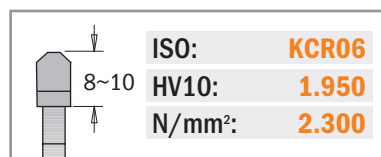
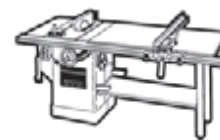
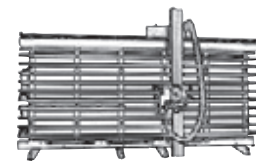
Laminated and chipboard saw blades *XTreme line***281 XTREME****APPLICATION:** for sizing cuts, perfect finishing without using scoring blade.**MACHINES:** table saws, horizontal and vertical sizing machines.**MATERIAL:** single or double-sided laminated panels.

D mm	B mm	Pin Hole 	Z	K mm	P mm	α	β	ORDER NO.
220	30	COMBI3	63	3,2	2,2	-3°	FFT	281.063.09M
250	30	COMBI3	60	3,2	2,2	-3°	FFT	281.061.10M
250	30	COMBI3	81	3,2	2,2	-3°	FFT	281.081.10M
300	30	COMBI3	72	3,2	2,2	-3°	FFT	281.073.12M
300	30	COMBI3	96	3,2	2,2	-3°	FFT	281.097.12M

DP laminated and chipboard saw blades *XTreme line*



237 XTREME



APPLICATION: for sizing cuts, perfect finishing (using scoring blade) and increased tool life up to 50 times longer than HW blades thanks to a special polycrystalline diamond formula. The best quality/price ratio!

MACHINES: table saws, horizontal and vertical sizing machines.

MATERIAL: one-side or double-sided plastic-laminated panels, MDF and HDF.

50X
LONGER LIFE
THAN CARBIDE

	ISO:	2µm
	HV10:	10.000
	Reafilabe:	6x

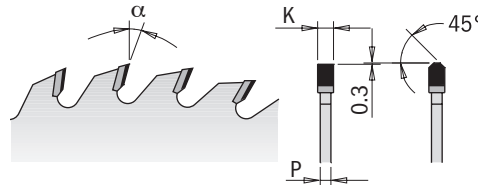

EXCELLENT

Two-sided melamine Wood products

D mm	B mm	Pin Hole	Z	K mm	P mm	α	β	ORDER NO.
250	30	COMBI3	48	3,2	2,2	10°	45° TCG	237.048.10M
300	30	COMBI3	60	3,2	2,2	10°	45° TCG	237.060.12M
300	30	COMBI3	96	3,2	2,2	15°	45° TCG	237.096.12M
350	30	COMBI3	72	3,5	2,4	15°	45° TCG	237.072.14M

High-quality nickel-plated saw blades with anti-friction and anti-corrosion properties.

DP conical scoring blades *XTreme line*



238 XTREME



APPLICATION: for chip-free scoring of the plastic-laminated panels; increased tool life up to 50 times longer than HW blades thanks to a special polycrystalline diamond formula. The best quality/price ratio!

MACHINES: horizontal and vertical sizing machines equipped with scoring device.

MATERIAL: one-side or double-sided plastic-laminated panels, MDF and HDF.

50X
LONGER LIFE
THAN CARBIDE

	ISO:	2µm
	HV10:	10.000
	Reafilabe:	6x

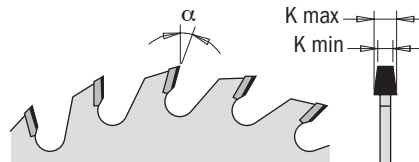

EXCELLENT

Two-sided melamine Wood products

D mm	B mm	Z	K mm	α	β	ORDER NO.
120	20	20	3,1-3,7	5°	CONICAL	238.120.20H
125	20	20	3,1-3,7	5°	CONICAL	238.125.20H

High-quality nickel-plated saw blades with anti-friction and anti-corrosion properties.

Saw blades

Jig saw blades

Tools with bore & Knives

Router bits & sets

CNC router cutter & chucks

Industrial dowel drills

Bits for hand power tools

Power tools & accessories

Display cabinets & spare parts

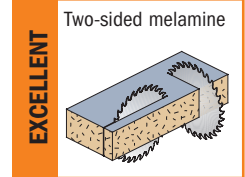
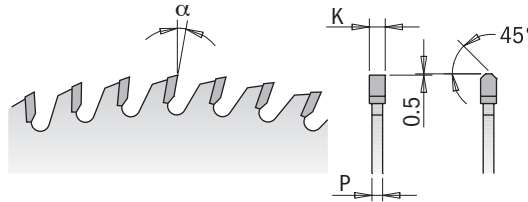
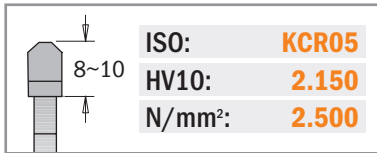
Panel sizing saw blades *industrial line***281-282****APPLICATION:** for sizing single sheets and multiple panels.**MACHINES:** horizontal panel sizing machines.**MATERIAL:** single or double-sided plastic-laminated panels, MDF.

D mm	B mm	Pin Hole 	Z	K mm	P mm	α	β	ORDER NO.
250	30	COMBI3	60	3,2	2,2	10°	TCG	281.060.10M
250	30	COMBI3	80	3,2	2,2	10°	TCG	281.080.10M
300	30	COMBI3	60	4,4	3,2	16°	TCG	282.060.12M
300	30	COMBI3	72	3,2	2,2	10°	TCG	281.072.12M
300	30	COMBI3	96	3,2	2,2	10°	TCG	281.096.12M
300	75		60	4,4	3,2	16°	TCG	282.060.12X
300	80	COMBI5	60	4,4	3,2	16°	TCG	282.060.12W
new 320	65	2/9/100 + 2/9/110	60	4,4	3,2	16°	TCG	Y282.060.13J
350	30	COMBI3	54	4,4	3,2	16°	TCG	282.054.14M
350	30	COMBI3	72	4,4	3,2	16°	TCG	282.072.14M
350	30	COMBI3	108	3,5	2,5	10°	TCG	281.108.14M
350	50	3/12,5/80	72	4,4	3,2	16°	TCG	282.072.14T
350	60	2/14/100	72	4,4	3,2	16°	TCG	Y282.072.14U
350	75	4/15/105 + 3/7/100	54	4,4	3,2	16°	TCG	282.054.14X
350	75	4/15/105 + 3/7/100	72	4,4	3,2	16°	TCG	282.072.14X
350	80	COMBI5	54	4,4	3,2	16°	TCG	282.054.14W
350	80	COMBI5	72	4,4	3,2	16°	TCG	282.072.14W
355	30	2/7/42 + 2/10/60	72	4,4	3,2	16°	TCG	S282.03556
380	60	COMBI7	72	4,8	3,5	16°	TCG	282.072.15U
400	30	2/10/60	60	4,4	3,2	16°	TCG	282.060.16M
400	30	2/10/60	72	4,4	3,2	16°	TCG	282.072.16M
400	60	COMBI7	72	4,4	3,2	16°	TCG	282.072.16U
400	75	4/15/105	60	4,4	3,2	16°	TCG	282.060.16X
400	75	4/15/105	72	4,4	3,2	16°	TCG	282.072.16X
400	80	COMBI5	60	4,4	3,2	16°	TCG	282.060.16W
400	80	COMBI5	72	4,4	3,2	16°	TCG	282.072.16W
430	75	4 /15/105	72	4,4	3,2	16°	TCG	282.072.17X
430	80	COMBI5	72	4,4	3,2	16°	TCG	282.072.17W2
450	60	COMBI7	72	4,8	3,5	16°	TCG	282.072.18U
450	80	COMBI5	72	4,8	3,5	16°	TCG	282.072.18W2
500	60	COMBI7	72	4,8	3,5	16°	TCG	282.072.20U
500	80	COMBI5	72	4,8	3,5	16°	TCG	Y282.072.20W
550	100		72	5,2	3,5	16°	TCG	282.072.22A

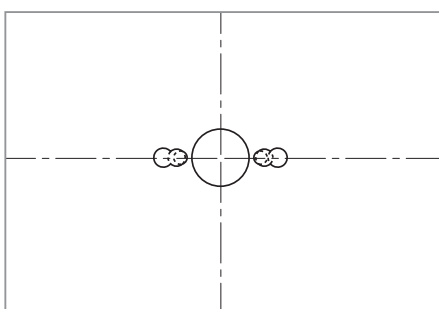
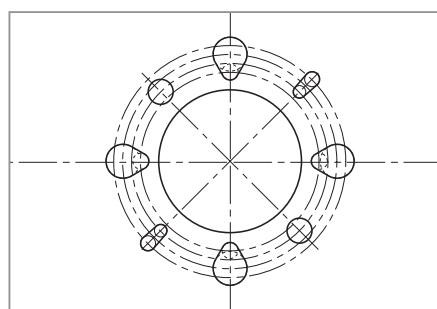
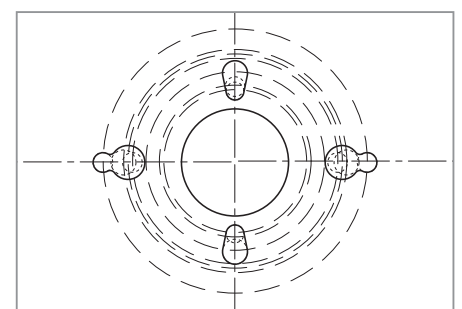
**COMBI3**2/7/42mm
2/9/46,4mm
2/10/60mm**COMBI5**2/7/110mm 4/9/100mm
2/8,4/130mm 4/19/120mm
2/14/110mm**COMBI7**2/10/80mm 2/11/148mm 2/14/125mm
1/11/85mm 2/14/100mm 2/19/120mm
2/11/115mm



288

APPLICATION: for chip-free scoring on plastic-laminated panels.

MACHINES: horizontal and vertical sizing machines equipped with scoring device for vertical adjustment.

MATERIAL: single or double-sided plastic-laminated panels, MDF.



ISO:	KCR05
HV10:	2.150
N/mm ² :	2.500

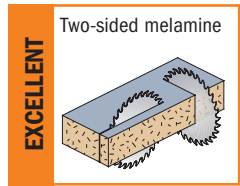
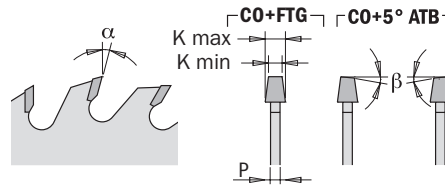

D mm	B mm	Pin Hole 	Z	K mm	P mm	α	β	ORDER NO.
80	20		12	3,1-4,0	2,2	10°	CO+FTG	S288.080.12H
100	20		20	3,1-4,0	2,5	5°	CO+5° ATB	288.100.20H
100	22		20	3,1-4,0	2,5	5°	CO+5° ATB	288.100.20K
120	20		24	3,1-4,0	2,5	5°	CO+5° ATB	288.120.24H
120	20		24	3,4-4,2	2,5	5°	CO+5° ATB	288.120.24H1
120	22		24	3,1-4,0	2,5	5°	CO+5° ATB	288.120.24K
125	20		24	3,1-4,0	2,5	5°	CO+5° ATB	288.125.24H
125	20		24	3,4-4,2	2,5	5°	CO+5° ATB	288.125.24H1
125	20		24	4,3-5,5	3,2	10°	CO+FTG	288.125.24H2
125	22		24	3,1-4,0	2,5	5°	CO+5° ATB	288.125.24K
125	45		24	4,3-5,5	3,2	10°	CO+FTG	288.125.24Q
140	16	1/6/33	24	3,1-4,0	2,2	10°	CO+FTG	Y288.140.24E
150	45		36	4,3-5,5	3,2	10°	CO+FTG	288.150.36Q
160	45	3/11/70	36	4,3-5,5	3,2	10°	CO+FTG	288.160.36Q
160	55	3/7/66	36	4,3-5,5	3,2	10°	CO+FTG	288.160.360
160	55	3/7/66 + 3/6/84	36	4,7-6,0	3,5	10°	CO+FTG	Y288.160.3602
180	20		36	4,3-5,5	3,2	10°	CO+FTG	Y288.180.36H
180	30		36	4,3-5,5	3,2	10°	CO+FTG	288.180.36M
180	45		36	4,7-6,0	3,5	10°	CO+FTG	288.180.36Q
180	55		36	5,0-6,2	3,5	10°	CO+FTG	288.180.360
180	50	3/12,5/80	44	4,3-5,5	3,2	10°	CO+FTG	288.180.44T
200	20		36	4,3-5,5	3,2	10°	CO+FTG	288.200.36H
200	45		36	4,7-6,0	3,5	10°	CO+FTG	288.200.36Q
200	45		36	4,3-5,5	3,2	10°	CO+FTG	Y288.200.36Q2
200	65	2/9/100 + 2/9/110	36	4,3-5,5	3,2	10°	CO+FTG	288.200.36J
215	50	3/15/80	42	4,3-5,5	3,2	10°	CO+FTG	288.215.42T
300	50	3/15/80	48	4,3-5,5	3,2	10°	CO+FTG	288.300.48T
300	65	2/9/100 + 2/9/110	72	4,3-5,5	3,2	10°	CO+FTG	288.300.72J

Adjustable scoring blades *industrial line*



289

APPLICATION: for chip-free scoring on plastic-laminated panels.

MACHINES: horizontal and vertical sizing machines equipped with scoring device not allowing for cutting depth adjustment.

MATERIAL: single or double-sided plastic-laminated panels, MDF.

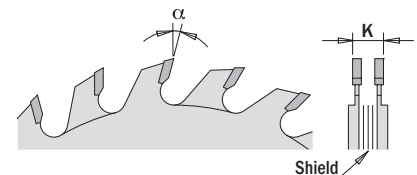
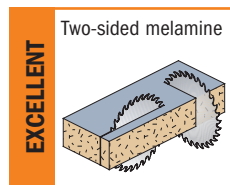

D mm	B mm	Pin Hole 	Z	K mm	α	β	ORDER NO.	Spare parts
70	20	2/3,1 - 3,8/32	8+8	2,8-3,6	15°	FLAT	289.070.16H	299.000.05H
80	20	2/3,1 - 3,8/42	10+10	2,8-3,6	15°	FLAT	289.080.20H	299.000.06H
100	20	2/3,1 - 3,8/42	10+10	2,8-3,6	15°	FLAT	289.100.20H	299.000.02K
100	22	2/3,1 - 3,8/42	10+10	2,8-3,6	15°	FLAT	289.100.20K	299.000.02K
120	20	2/3,1 - 3,8/42	12+12	2,8-3,6	15°	FLAT	289.120.24H	299.000.02K
120	22	2/3,1 - 3,8/42	12+12	2,8-3,6	15°	FLAT	289.120.24K	299.000.02K
120	50	4/6,2 - 10/62	12+12	2,8-3,6	15°	FLAT	289.120.24T	
125	20	2/3,1 - 3,8/42	12+12	2,8-3,6	15°	FLAT	289.125.24H	299.000.02K
125	22	2/3,1 - 3,8/42	12+12	2,8-3,6	15°	FLAT	289.125.24K	299.000.02K

Industrial chrome-coated scoring blades

new

CMT ORANGE TOOLS™



288 conical



ORANGE CHROME™

289 adjustable

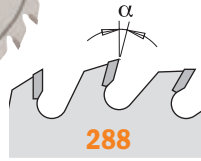

288

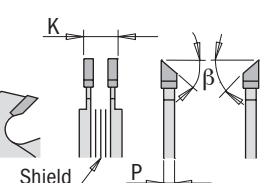
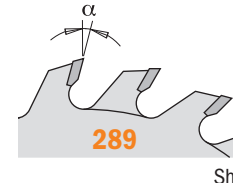
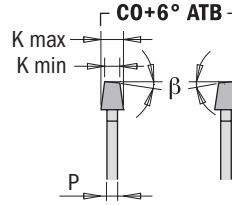
**APPLICATION:** for chip-free scoring on plastic-laminated panels.**MACHINES:** horizontal and vertical sizing machines equipped with scoring device.**MATERIAL:** single or double-sided plastic-laminated panels, MDF.ISO: **KCR05**HV10: **2.150**N/mm²: **2.500**

D mm	B mm	Pin Hole 	Z	K mm	P mm	α	β	ORDER NO.
120	20		24	3,1-4,3	2,2	0°	CO+6° ATB	288.720.24H
120	22		24	3,1-4,3	2,2	0°	CO+6° ATB	288.720.24K
125	20		24	3,1-4,3	2,2	0°	CO+6° ATB	288.725.24H
120	20	2/4,2/42	12+12	2,8-3,6		11°	5° ATB	289.720.24H
120	22	2/4,2/42	12+12	2,8-3,6		11°	5° ATB	289.720.24K
125	20	2/4,2/42	12+12	2,8-3,6		11°	5° ATB	289.725.24H

Non-ferrous metal and plastic material saw blades *industrial line*

284

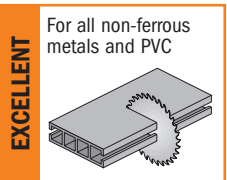
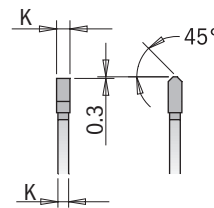
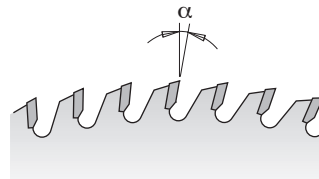
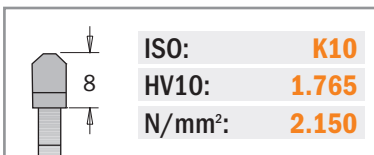
APPLICATION: for cutting and dividing tubes, drawn products and solid blocks.**MACHINES:** table saws, single or double mitre saws with mechanical clamping of the workpiece.**MATERIAL:** aluminium, brass, copper alloys, plastic, composite materials.**WARNING:** it is recommended to properly clamp the workpiece during cutting operations and to use a liquid lubricant. Wax stick for lubrication NOT RECOMMENDED.

Saw blades for portable machines. Positive hook angle

D mm	B mm	Pin Hole 	Z	K mm	P mm	α	β	ORDER NO.
160	20	-	24	2,2	1,6	5°	TCG	Y284.160.24H
190	30	-	30	2,6	2,2	5°	TCG	Y284.190.30M

Remarks: in plastic carry case.

Saw blades for industrial machines. Positive hook angle

D mm	B mm	Pin Hole 	Z	K mm	P mm	α	β	ORDER NO.
250	32	2/12/64	80	3,2	2,5	5°	TCG	284.080.10P
300	32	2/12/64	96	3,2	2,5	5°	TCG	284.096.12P
350	32	2/12/64	92	3,2	2,5	5°	TCG	284.092.14P
350	32	2/12/64	108	3,2	2,5	5°	TCG	284.108.14P
400	32	2/12/64	96	3,8	3,2	5°	TCG	284.096.16P
420	32	2/12/64	96	3,8	3,2	5°	TCG	284.096.17P
450	32	2/12/64	108	3,8	3,2	5°	TCG	284.108.18P
500	32	2/12/64	120	4,0	3,2	5°	TCG	284.120.20P

Remarks: in cardboard box.



296-297



APPLICATION: for cutting and dividing tubes, drawn products and solid blocks.

MACHINES: single or double mitre saws, radial saws.
Recommended use with the saw blade over the workpiece.
Use series 296 for portable machines.

MATERIAL: aluminium, brass, copper alloys, plastic, composite material, melamine and laminated panels.

WARNING: it is recommended to use a liquid lubricant.
Wax stick for lubrication NOT RECOMMENDED.

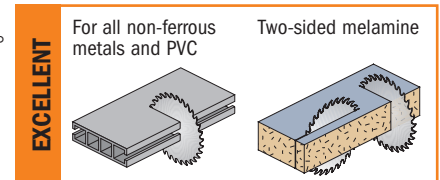
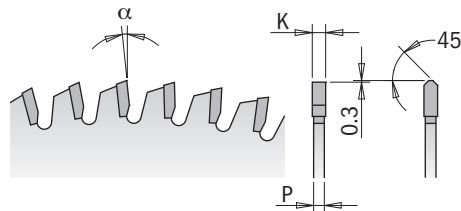
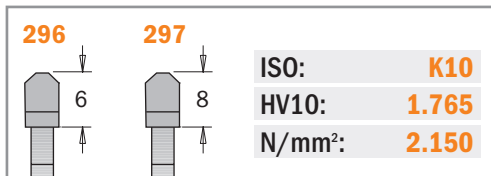

Saw blades for portable machines. Negative hook angle

D mm	B mm	Pin Hole ⊕⊖	Z	K mm	P mm	α	β	ORDER NO.
120*	20	2/5,5/30	36	1,8	1,2	-6° Neg.	TCG	296.120.36H
160*	20	2/6/32	40	2,2	1,6	-6° Neg.	TCG	296.160.40H
160*	20	2/6/32	56	2,2	1,6	-6° Neg.	TCG	296.160.56H
180*	20	2/6/32	40	2,8	2,2	-6° Neg.	TCG	296.180.40H
190*	30	2/7/42	40	2,8	2,2	-6° Neg.	TCG	296.190.40M
190*	30	2/7/42	64	2,8	2,2	-6° Neg.	TCG	296.190.64M
190*	20 (Festool® FF)	Key 5/7/2,5	64	2,8	2,2	-6° Neg.	TCG	296.190.64FF
200*	30	COMBI3	48	2,8	2,2	-6° Neg.	TCG	296.200.48M
210*	30	2/7/42	48	2,8	2,2	-6° Neg.	TCG	296.210.48M
210*	30	2/7/42	64	2,8	2,2	-6° Neg.	TCG	296.210.64M
216*	30		64	2,8	2,2	-6° Neg.	TCG	297.064.09M
225*	30	2/7/42	64	2,8	2,2	-6° Neg.	TCG	296.225.64M
230*	30	2/7/42	48	2,8	2,2	-6° Neg.	TCG	296.230.48M
235*	30	2/7/42	48	2,8	2,2	-6° Neg.	TCG	296.235.48M

*Non-low noise

Remarks: in plastic carry case.

Saw blades to fit on trim- and mitre saws, table saws and combined joinery machines. Negative hook angle

D mm	B mm	Pin Hole ⊕⊖	Z	K mm	P mm	α	β	ORDER NO.
250	30	COMBI3	80	3,2	2,5	-6° Neg.	TCG	297.080.10M
250	32	2/12/64	80	3,2	2,5	-6° Neg.	TCG	297.080.10P
254	30	COMBI3	80	3,2	2,5	-5° Neg.	TCG	297.081.10M
260	30	2/10/60 + 2/7/42	80	2,8	2,2	-6° Neg.	TCG	297.080.11M
280*	30	2/10/60 + 2/7/42	64	3,2	2,5	-6° Neg.	TCG	297.064.11M
300	30	COMBI3	96	3,2	2,5	-6° Neg.	TCG	297.096.12M
300	32	2/12/64	96	3,2	2,5	-6° Neg.	TCG	297.096.12P
305*	30	2/10/60 + 2/7/42	96	3,2	2,5	-6° Neg.	TCG	297.096.13M
315	30	2/10/60 + 2/7/42	96	3,2	2,5	-6° Neg.	TCG	297.096.23M
330	30	COMBI3	96	3,2	2,5	-6° Neg.	TCG	297.096.33M
330	32	COMBI3	96	3,2	2,5	-6° Neg.	TCG	297.096.33P
350	30	COMBI3	108	3,2	2,5	-6° Neg.	TCG	297.108.14M
350	32	4/12/64	108	3,2	2,5	-6° Neg.	TCG	297.108.14P
400	30	2/10/60	120	3,8	3,2	-6° Neg.	TCG	297.120.16M
400	32	4/12/64	108	3,8	3,2	-6° Neg.	TCG	297.108.16P
450	30	2/10/60	140	3,8	3,2	-6° Neg.	TCG	Y297.140.18M
450	32	2/12/64	108	3,8	3,2	-6° Neg.	TCG	297.108.18P
500	32	2/12/64	120	4,0	3,2	-6° Neg.	TCG	297.120.20P

*Non-low noise

Remarks: in cardboard box.

Dry cutter saw blades *industrial line***226****APPLICATION:** for crosscutting on different kinds of materials.**MACHINES:** dry-cutter and mitre saws without lubrication.**MATERIAL:** for ferrous materials and constructional steel.**WARNING:** not recommended for non-ferrous metals, wood, glass, concrete, plastic.

ISO:	K30
HV10:	1.520
N/mm ² :	2.300

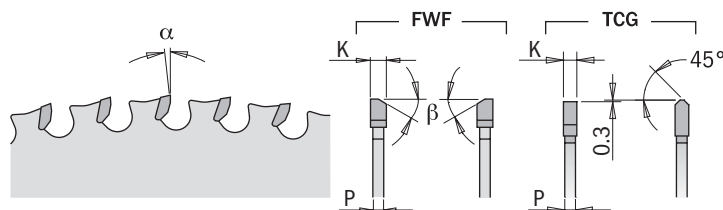
**EXCELLENT**

For iron, steel, PVC, compound materials, melamine

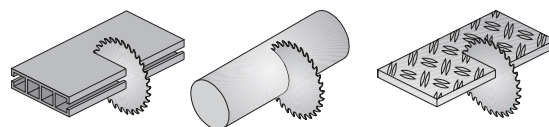

D mm	B mm	Pin Hole 	RPM suggested	RPM max	Z	K mm	P mm	α	β	ORDER NO.
136,5*	10		5500	10900	30	1,5	1,2	0°	TCG	226.030.05
136,5*	20		5500	10900	30	1,5	1,2	0°	TCG	226.030.05H
160	20	2/6/32	4700	9300	30	2,0	1,6	0°	TCG	226.030.06H
165	15,87<>		4600	9000	36	1,5	1,2	0°	TCG	226.036.06
165	20	2/6/32	4600	9000	36	1,5	1,2	0°	TCG	226.036.06H
184	15,87<>		4100	8000	48	2,0	1,6	0°	TCG	226.048.07
190	30	2/7/42	4000	8000	40	2,0	1,6	0°	TCG	226.040.07M
210	15,87<>		3600	7300	48	2,2	1,8	0°	TCG	226.048.08
210	30	2/7/42	3600	7300	48	2,2	1,8	0°	TCG	226.048.08M
new 216	30	2/7/42	3500	7000	48	2,2	1,8	0°	TCG	226.047.09M
235	30	2/7/42	3200	6400	48	2,2	1,8	0°	TCG	226.048.09M
254	15,87		3000	5900	48	2,2	1,8	0°	8° FWF	226.048.10
254	15,87		3000	5900	60	2,2	1,8	0°	8° FWF	226.060.10
254**	30	COMBI3	3000	5900	60	2,2	1,8	0°	8° FWF	226.060.10M
305	25,4		2500	4900	60	2,2	1,8	0°	8° FWF	226.060.12
305	25,4		2500	4900	80	2,2	1,8	0°	8° FWF	226.080.12
305**	30	COMBI3	2500	4900	80	2,2	1,8	0°	8° FWF	226.080.12M
new 355	25,4		2100	4200	72	2,2	1,8	0°	8° FWF	226.072.14
355	25,4		2100	4200	90	2,2	1,8	0°	8° FWF	226.090.14
355**	30	COMBI3	2100	4200	90	2,2	1,8	0°	8° FWF	226.090.14M

*Non-low noise

** Remarks: in cardboard box.

Industrial XTreme saw blades for stainless steel

new**CERMET**

D mm	B mm	Pin Hole 	RPM suggested.	RPM max	Z	K mm	P mm	α	β	ORDER NO.
160	20	2/6/32	4700	9300	40	1,8	1,4	10°	TCG	226.540.06H
184	15,87<>		4100	8000	48	2,0	1,6	10°	TCG	226.548.07
190	30	2/7/42	4000	8000	48	1,8	1,4	10°	TCG	226.548.07M
216	30	2/7/42	3600	6900	56	1,8	1,4	10°	TCG	226.556.09M
250**	30	COMBI3	3000	5900	72	2,2	1,8	10°	8° FWF	226.572.10M
254	15,87		3000	5900	72	2,2	1,8	10°	8° FWF	226.572.10
300**	30	COMBI3	2500	4900	80	2,2	1,8	10°	8° FWF	226.580.12M
305	25,4		2500	4900	80	2,2	1,8	10°	8° FWF	226.580.12
355	25,4		2100	4200	90	2,2	1,8	10°	8° FWF	226.590.14
355**	30	COMBI3	2100	4200	90	2,2	1,8	10°	8° FWF	226.590.14M

** Remarks: in cardboard box.



223

APPLICATION: for swirl free cuts.
MACHINES: table saws and Panel sizing.
MATERIAL: solid surface materials (Dupont Corian®, Wilsonart Gibraltar®, SSV Fountainhead®, Varicor®, etc.) and thick plastic.
WARNING: not recommended for use on mitre saws.



	ISO: KCR06
	HV10: 1.950
	N/mm ² : 2.300

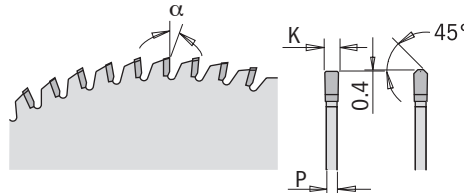

EXCELLENT

Solid surface	Thick plastic

D mm	B mm	Pin Hole 	Z	K mm	P mm	α	β	ORDER NO.
250	30	COMBI3	72	3,2	2,5	0°	MTCG	223.072.10M
300	30	COMBI3	84	3,2	2,5	0°	MTCG	223.084.12M

PVC & plexiglass saw blades *Industrial line*



222

APPLICATION: for perfect cuts without melting and scratching.
MACHINES: table saws, Panel sizing and mitre saws.
MATERIAL: thin plastic, plexiglass, vinyl, plywood, laminated flooring.



	ISO: KCR06
	HV10: 1.950
	N/mm ² : 2.300

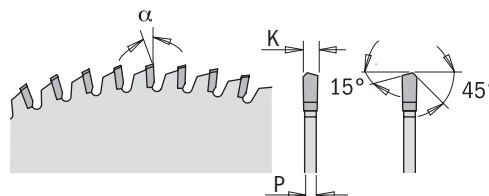

EXCELLENT

Plexiglass and Vinyl	Thin plastic

GOOD

Plywood	Two-sided melamine

D mm	B mm	Pin Hole 	Z	K mm	P mm	α	β	ORDER NO.
250	30	COMBI3	80	2,8	2,2	-3°	MATB	222.080.10M
300	30	COMBI3	96	2,8	2,2	-3°	MATB	222.096.12M

ITK Plus ripping saw blades

new

CMT ORANGE TOOLS™



ISO:	K20
HV10:	1.550
N/mm ² :	2.300

271

APPLICATION: for rip cuts at high-speed rotation. The blade considerably reduces material waste thanks to the thin-kerf design. Particularly suitable for valuable wood.

MACHINES: miter saws, table saws, portable and cordless saws.

MATERIAL: soft and hardwood.

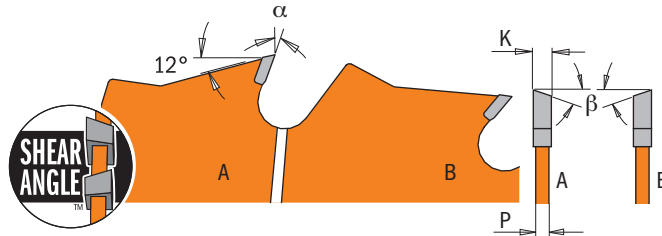

D mm	B mm	Pin Hole 	Z	K mm	P mm	α	β	ORDER NO.
250	30	COMBI3	24	2,4	1,6	20°	10° ATB + 8° Shear	271.250.24M
300	30	COMBI3	24	2,6	1,8	22°	10° ATB + 8° Shear	271.300.24M

ITK Plus rip and crosscut saw blades

new



ISO:	K20
HV10:	1.550
N/mm ² :	2.300

271

APPLICATION: for rip and crosscuts at high-speed rotation. The blade considerably reduces material waste thanks to the thin-kerf design. Particularly suitable for valuable wood.

MACHINES: miter saws, table saws, portable and corless saws.

MATERIAL: soft and hardwood, plywood.

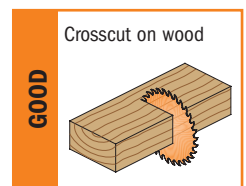
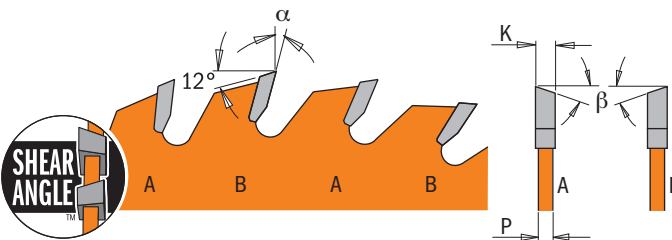

D mm	B mm	Pin Hole 	Z	K mm	P mm	α	β	ORDER NO.
136	20 (+10)		18	1,5	1,0	20°	10° ATB + 8° Shear	271.136.18H
150	20 (+16)		24	1,5	1,0	18°	10° ATB + 8° Shear	271.150.24H
160	20 (+16)	2/6/32	24	1,7	1,1	18°	10° ATB + 8° Shear	271.160.24H
165	20 (+15,87)	2/6/32	24	1,7	1,1	18°	10° ATB + 8° Shear	271.165.24H
184	20 (+16+15,87)	2/7/42	24	1,7	1,1	20°	10° ATB + 8° Shear	271.184.24H
184	30	2/7/42	24	1,7	1,1	20°	10° ATB + 8° Shear	271.184.24M
190	30 (+20+16)	2/7/42	24	1,7	1,1	20°	10° ATB + 8° Shear	271.190.24M
200	30	2/7/42	36	1,8	1,2	15°	10° ATB + 8° Shear	271.200.36M
210	30 (+25)	2/7/42	36	1,8	1,2	15°	10° ATB + 8° Shear	271.210.36M
216	30		36	1,8	1,2	-5° Neg.	10° ATB + 8° Shear	271.216.36M
235	30 (+25)	2/7/42	36	2,4	1,6	18°	10° ATB + 8° Shear	271.235.36M
250	30	COMBI3	42	2,4	1,6	18°	10° ATB + 8° Shear	271.250.42M
300	30	COMBI3	48	2,6	1,8	18°	10° ATB + 8° Shear	271.300.48M



272

APPLICATION: for rip and crosscuts at high-speed rotation. The blade considerably reduces material waste thanks to the thin-kerf design. Particularly suitable for valuable wood.
MACHINES: miter saws, table saws, portable and cordless saws.
MATERIAL: soft and hardwood, plywood.

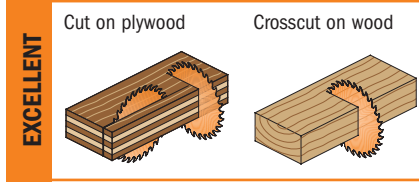
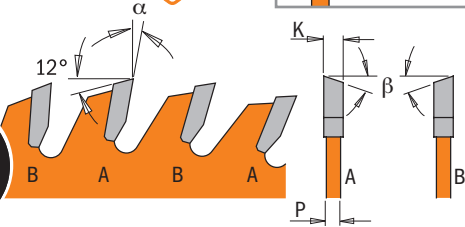
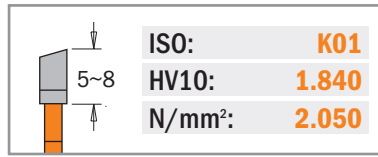

D mm	B mm	Pin Hole	Z	K mm	P mm	α	β	ORDER NO.
136	20 (+10)		36	1,5	1,0	18°	10° ATB + 8° Shear	272.136.36H
150	20 (+16)		40	1,5	1,0	16°	10° ATB + 8° Shear	272.150.40H
160	20 (+16)	2/6/32	40	1,7	1,1	16°	10° ATB + 8° Shear	272.160.40H
165	20 (+15,87)	2/6/32	36	1,7	1,1	20°	10° ATB + 8° Shear	272.165.36H
184	20 (+16+15,87)	2/7/42	40	1,7	1,1	18°	10° ATB + 8° Shear	272.184.40H
184	30	2/7/42	40	1,7	1,1	18°	10° ATB + 8° Shear	272.184.40M
190	30 (+20+16)	2/7/42	42	1,7	1,1	18°	10° ATB + 8° Shear	272.190.42M
200	30	2/7/42	48	1,8	1,2	15°	10° ATB + 8° Shear	272.200.48M
210	30 (+25)	2/7/42	48	1,8	1,2	15°	10° ATB + 8° Shear	272.210.48M
216	30		48	1,8	1,2	-5° Neg.	10° ATB + 8° Shear	272.216.48M
235	30 (+25)	2/7/42	48	2,4	1,6	18°	10° ATB + 8° Shear	272.235.48M
250	30	COMBI3	60	2,4	1,6	15°	10° ATB + 8° Shear	272.250.60M
300	30	COMBI3	72	2,6	1,8	15°	10° ATB + 8° Shear	272.300.72M

ITK Plus fine cut-off saw blades



273

APPLICATION: for crosscuts and finish cuts. The blade considerably reduces material waste thanks to the thin-kerf design. Particularly suitable for valuable wood.
MACHINES: miter saws, table saws, portable and cordless saws.
MATERIAL: soft and hardwood, exotic wood, plywood and laminates.

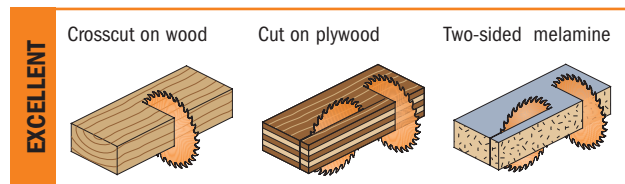
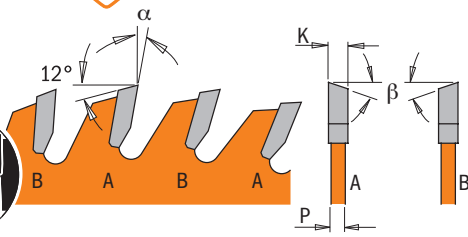
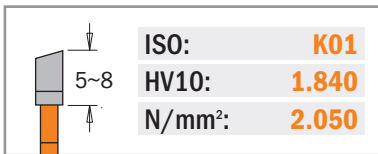

D mm	B mm	Pin Hole	Z	K mm	P mm	α	β	ORDER NO.
160	20 (+16)	2/6/32	56	1,7	1,1	12°	10° ATB + 8° Shear	273.160.56H
190	30 (+20+16)	2/7/42	64	1,7	1,1	15°	10° ATB + 8° Shear	273.190.64M
216	30		64	1,8	1,2	-5° Neg.	10° ATB + 8° Shear	273.216.64M
250	30	COMBI3	80	2,4	1,6	12°	10° ATB + 8° Shear	273.250.80M
300	30	COMBI3	96	2,6	1,8	12°	10° ATB + 8° Shear	273.300.96M

Saw blades for building contractors *for portable machines*

250-251

APPLICATION: for rip cuts especially designed for building contractors.

MACHINES: portable and cordless machines.

MATERIAL: single and hardwood, panels with nails, metal clips and pieces of concrete.



*Kit 10 pcs.

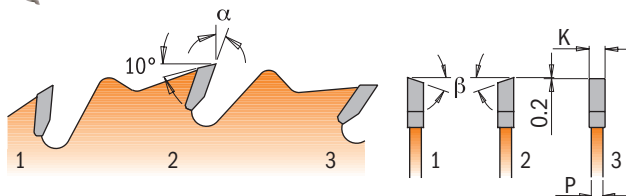

EXCELLENT

Rip cut on wood (serie 250)

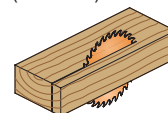

Crosscut on wood (serie 251)

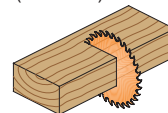

D	B	Z	K	P	α	β	ORDER NO.
mm	mm		mm	mm			
184	15,87 \triangleleft	24	1,9	1,2	20°	1FTG+2/20° ATB	250.024.07
184	15,87 \triangleleft	24	1,9	1,2	20°	1FTG+2/20° ATB	250.024.07-X10*
184	15,87 \triangleleft	40	1,9	1,2	20°	1FTG+4/20° ATB	251.040.07
184	15,87 \triangleleft	40	1,9	1,2	20°	1FTG+4/20° ATB	251.040.07-X10*

Ultra thin-kerf saw blades *for cordless saws*

new



271-272-226

APPLICATION (series 271-272): for rip and crosscuts where the ultra thin-kerf reduces material wastes.

MACHINES (series 271-272): portable cordless machines.

MATERIAL (series 271-272): soft and hardwood, plywood.



EXCELLENT

Rip cut on wood (serie 271)

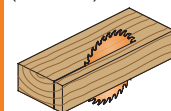

EXCELLENT

Crosscut on wood (serie 272)

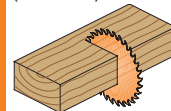

EXCELLENT

Metals and PVC (serie 226)

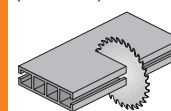

APPLICATION (series 226): for crosscuts of different kinds of materials.

MACHINES (series 226): portable cordless machines.

MATERIAL (series 226): for ferrous materials and construction steel.

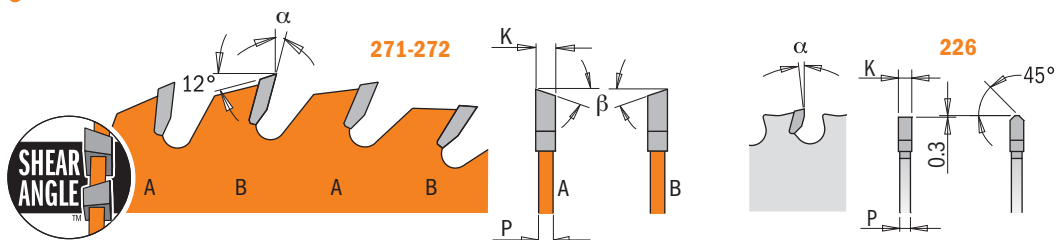

D	B	Pin Hole	Z	K	P	α	β	ORDER NO.
mm	mm			mm	mm			
Ripping cordless saw blades (series 271)								
136	20 (+10)		18	1,5	1,0	20°	10° ATB + 8° Shear	271.136.18H
165	20 (+15,87)	2/6/32	24	1,7	1,1	18°	10° ATB + 8° Shear	271.165.24H
184	20 (+16+15,87)	2/7/42	24	1,7	1,1	20°	10° ATB + 8° Shear	271.184.24H
Crosscutting cordless saw blades (series 272)								
136	20 (+10)		36	1,5	1,0	18°	10° ATB + 8° Shear	272.136.36H
165	20 (+15,87)	2/6/32	36	1,7	1,1	20°	10° ATB + 8° Shear	272.165.36H
184	20 (+16+15,87)	2/7/42	40	1,7	1,1	18°	10° ATB + 8° Shear	272.184.40H
Metal, PVC and compound material cordless saw blades (series 226)								
136,5	10		30	1,5	1,2	0°	TCG	226.030.05
136,5	20		30	1,5	1,2	0°	TCG	226.030.05H
165	15,87 \triangleleft		36	1,5	1,2	0°	TCG	226.036.06

DP saw blades for ultra-hard materials



236

APPLICATION: for rip and crosscuts on abrasive materials.
MACHINES: mitre saws, portable and cordless machines.
MATERIAL: cement fibre boards (Hardieplank® and Hardiepanel®), plasterboard, solid wood, panel materials, plastic.

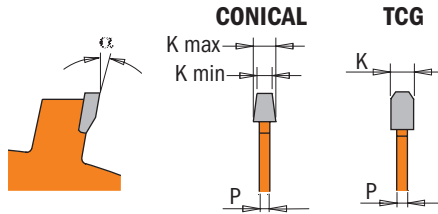

GOOD

Hardieplank® and Hardiepanel®, chipboard, MDF, Corian, Duroplast, Formica, Thermoplast, and plasterboard.

D mm	B mm	Pin Hole	Z	K mm	P mm	α	β	ORDER NO.
160	20	2/6/32	4	2,1-2,2	1,6	12°	CONICAL	236.160.04H
160	20	2/6/32	10	2,1-2,2	1,6	12°	CONICAL	236.160.10H
180	20	2/6/32	4	2,1-2,2	1,6	12°	CONICAL	236.180.04H
184	15,87<->		4	1,8	1,4	12°	TCG	236.004.07
190	30	2/7/42	4	2,1-2,2	1,6	12°	CONICAL	236.190.04M
190	30	2/7/42	12	2,1-2,2	1,6	12°	CONICAL	236.190.12M
216	30		14	2,1-2,2	1,6	12°	CONICAL	236.216.14M
230	30	2/7/42	4	2,1-2,2	1,6	12°	CONICAL	236.230.04M
250	30	COMBI3	16	2,1-2,2	1,6	12°	CONICAL	236.250.16M
254	15,87		6	2,2	1,6	12°	TCG	236.006.10
300	30	COMBI3	20	2,1-2,2	1,6	12°	CONICAL	236.300.20M
305	25,4		8	2,2	1,6	12°	TCG	236.008.12

Rip saw blades for portable machines



290

APPLICATION: for rip cuts.
MACHINES: mitre saws and portable machines.
MATERIAL: soft and hardwood.

ISO: K10
HV10: 1.765
N/mm²: 2.150

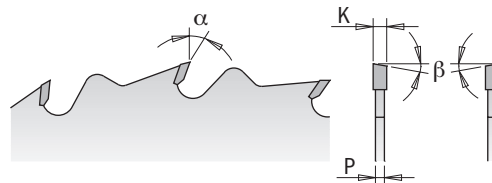

EXCELLENT Rip cut on wood

D mm	B mm	Pin Hole	Z	K mm	P mm	α	β	ORDER NO.
150	20		12	2,4	1,4	20°	10° ATB	290.150.12H
160	16		12	2,2	1,6	20°	10° ATB	290.160.12E
160	20	2/6/32	12	2,2	1,6	20°	10° ATB	290.160.12H
180	30	2/7/42	12	2,6	1,6	20°	10° ATB	290.180.12M
190	16	2/6/32	12	2,6	1,6	20°	10° ATB	290.190.12E
190	20	2/6/32	12	2,6	1,6	20°	10° ATB	290.190.12H
190	30	2/7/42	12	2,6	1,6	20°	10° ATB	290.190.12M
200	30	2/7/42	24	2,8	1,8	20°	10° ATB	290.200.24M
210	30	2/7/42	24	2,8	1,8	20°	10° ATB	290.210.24M
216	30		24	2,8	1,8	-5° Neg.	15° ATB	290.216.24M
220	30	2/7/42	24	2,8	1,8	20°	10° ATB	290.220.24M
230	30	2/7/42	24	2,8	1,8	20°	10° ATB	290.230.24M
235	25		24	2,8	1,8	20°	10° ATB	290.235.24L
235	30	2/7/42	24	2,8	1,8	20°	10° ATB	290.235.24M
240	30	2/7/42	24	2,8	1,8	20°	10° ATB	290.240.24M
250	30	COMBI3	24	2,8	1,8	20°	10° ATB	290.250.24M*
270	30	2/7/42	28	2,8	1,8	20°	10° ATB	290.270.28M*

* Industrial quality

Contractor saw blade masterpack

new

CMT ORANGE TOOLS™



K (Contractor)

MACHINES: portable benchtop and table saws.**MATERIAL:** soft/hard wood, plywood, osb panels.

Designed for construction project, remodeler and DIY, these blades deliver solid performance at a very economical price.



Kit 10 pcs.

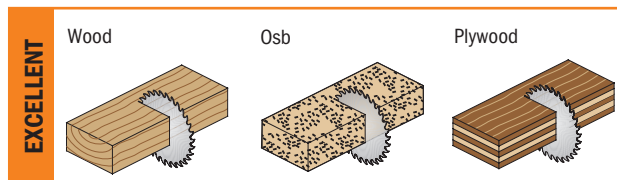
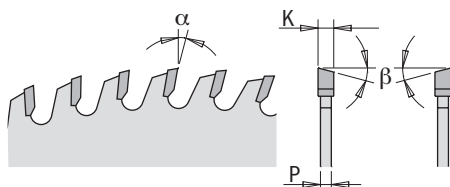

DESCRIPTION	D mm	B mm	Pin Hole	Z	K mm	P mm	α	β	ORDER NO.
Crosscut (pack 10 blades)	160	20	2/6/32	24	2,2	1,4	15°	15° ATB	K16024H-X10
Fine cut-off (pack 10 blades)	160	20	2/6/32	40	2,2	1,4	15°	15° ATB	K16040H-X10
Crosscut (pack 10 blades)	190	30	2/7/42	24	2,2	1,4	20°	10° ATB	K19024M-X10
Crosscut (pack 10 blades)	216	30		24	2,4	1,6	-5° Neg.	15° ATB	K21624M-X10
Fine cut-off (pack 10 blades)	216	30		48	2,4	1,6	-5° Neg.	15° ATB	K21648M-X10
Crosscut (pack 5 blades)	250	30	COMBI3	40	2,6	1,8	15°	10° ATB	K25040M-X05

Ultra thin-kerf saw blades for cordless saws



298

APPLICATION: for cutting grass, bushes and small trees.**MACHINES:** hedge trimmers.**MATERIAL:** grass, bushes and small trees.**WARNING:** please always wear safety glasses and ear protection and read the safety recommendations provided.

ISO:	SPECIAL
HV10:	1.550
N/mm ² :	2.600

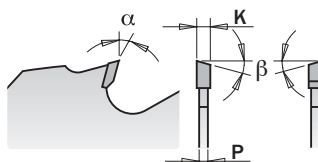

D mm	B mm	RPM max	Z	K mm	P mm	α	β	ORDER NO.
250	20	12.000	20	2,2	1,4	15°	10° ATB	298.250.20H
250	25,4	12.000	20	2,2	1,4	15°	10° ATB	298.250.20



285-291

APPLICATION: for rip and crosscuts.

MACHINES: table and mitre saws, portable machines.

MATERIAL: soft and hardwood, plywood.

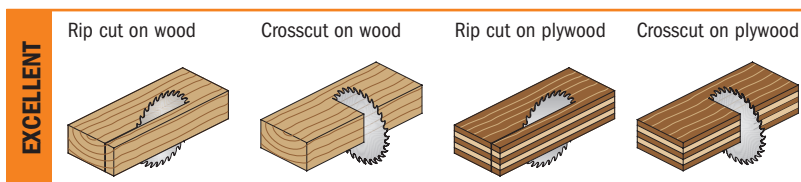
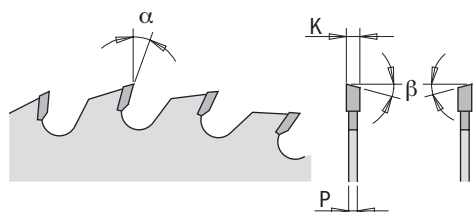
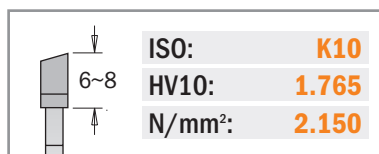
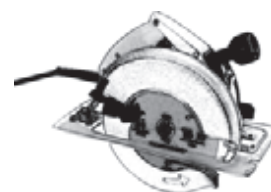

D mm	B mm	Pin Hole 	Z	K mm	P mm	α	β	ORDER NO.
120	20	2/5,5/30	18	1,8	1,2	15°	15° ATB	291.120.18H*
125	20		20	2,4	1,4	15°	15° ATB	291.125.20H
130	20		20	2,4	1,4	15°	15° ATB	291.130.20H
140	20		20	2,4	1,4	15°	15° ATB	291.140.20H
150	16		24	2,4	1,4	15°	15° ATB	291.150.24E
150	20		24	2,4	1,4	15°	15° ATB	291.150.24H
160	16		24	2,2	1,6	15°	15° ATB	291.160.24E
160	20	2/6/32	24	2,2	1,6	15°	15° ATB	291.160.24H
160	30	2/7/42	24	2,2	1,6	15°	15° ATB	291.160.24M
165	20	2/6/32	24	2,6	1,6	15°	15° ATB	291.165.24H
165	30	2/7/42	24	2,6	1,6	15°	15° ATB	291.165.24M
170	30	2/7/42	24	2,6	1,6	20°	10° ATB	291.170.24M
180	20	2/6/32	24	2,6	1,6	20°	10° ATB	291.180.24H
180	30	2/7/42	24	2,6	1,6	20°	10° ATB	291.180.24M
184	16		24	2,6	1,6	20°	10° ATB	291.184.24E
184	30		24	2,6	1,6	20°	10° ATB	291.184.24M
190	16	2/6/32	24	2,6	1,6	20°	10° ATB	291.190.24E
190	20	2/6/32	24	2,6	1,6	20°	10° ATB	291.190.24H
190	30	2/7/42	24	2,6	1,6	20°	10° ATB	291.190.24M
190	20 (Festool® FF)	Key 5/7/2,5	32	2,6	1,6	10°	10° ATB	291.190.32FF
200	30	2/7/42	36	2,8	1,8	15°	15° ATB	291.200.36M
210	25		36	2,8	1,8	15°	15° ATB	291.210.36L
210	30	2/7/42	36	2,8	1,8	15°	15° ATB	291.210.36M
216	30		48	2,8	1,8	-5° Neg.	15° ATB	291.216.48M
220	30	2/7/42	36	2,8	1,8	15°	15° ATB	291.220.36M
225	30	2/7/42	36	2,8	1,8	20°	15° ATB	291.225.36M
230	30	2/7/42	36	2,8	1,8	15°	15° ATB	291.230.36M
235	25		36	2,8	1,8	15°	15° ATB	291.235.36L
235	30	2/7/42	36	2,8	1,8	15°	15° ATB	291.235.36M
240	30	2/7/42	36	2,8	1,8	15°	15° ATB	291.240.36M
250	20	COMBI3	40	3,2	2,2	15°	10° ATB	285.040.10H*
250	30	COMBI3	40	3,2	2,2	15°	10° ATB	285.040.10M*
260	30	2/10/60 + 2/7/42	48	2,8	1,8	15°	10° ATB	285.048.11M*
270	30	2/7/42	42	2,8	1,8	15°	15° ATB	291.270.42M*

* Industrial quality

Fine cut-off saw blades for portable machines





281-285-292

APPLICATION: for crosscuts, perfect finishing.

MACHINES: table and mitre saws, portable machines.

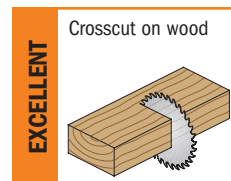
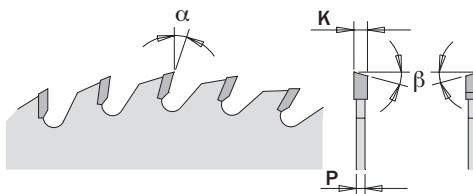
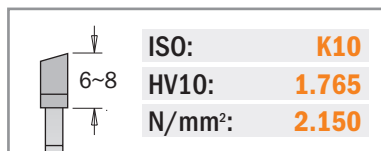
MATERIAL: soft, hard and exotic wood, wood-based panels, one-sided veneered, paper-based laminated.



	D mm	B mm	Pin Hole 	Z	K mm	P mm	α	β	ORDER NO.
NEW	120	20	2/5,5/30	36	1,8	1,2	10°	15° ATB	292.120.36H*
	120	20	2/5,5/30	40	1,8	1,2	10°	15° ATB	292.120.40H
NEW	125	20	-	36	2,4	1,4	15°	15° ATB	292.125.36H
NEW	130	20	-	36	2,4	1,4	15°	15° ATB	292.130.36H
NEW	140	20	-	36	2,4	1,4	15°	15° ATB	292.140.36H
	150	20	-	40	2,4	1,4	15°	15° ATB	292.150.40H
	160	16	-	40	2,2	1,6	10°	15° ATB	292.160.40E
	160	20	2/6/32	40	2,2	1,6	10°	15° ATB	292.160.40H
	160	20 (Virutex)	4/7/32 (45°)	40	2,2	1,6	10°	TCG	281.160.40H
NEW	160*	20	2/6/32	40	2,2	1,6	10°	TCG	281.160.40H2
	160	30	2/7/42	40	2,2	1,6	10°	15° ATB	292.160.40M
	160	20	2/7/42	56	2,2	1,6	15°	15° ATB	292.160.56H
	165	20	2/6/32	40	2,6	1,6	10°	15° ATB	292.165.40H
NEW	165	20	2/7/42	56	2,2	1,6	15°	15° ATB	292.165.56H
	165	30	2/7/42	40	2,6	1,6	15°	15° ATB	292.165.40M
	170	30	2/7/42	40	2,6	1,6	15°	15° ATB	292.170.40M
	180	20	2/6/32	40	2,6	1,6	15°	15° ATB	292.180.40H
	180	30	2/7/42	40	2,6	1,6	15°	15° ATB	292.180.40M
	184	16		40	2,6	1,6	15°	15° ATB	292.184.40E
	184	30		40	2,6	1,6	15°	15° ATB	292.184.40M
	190	16	2/6/32	40	2,6	1,6	15°	15° ATB	292.190.40E
	190	20	2/6/32	40	2,6	1,6	15°	15° ATB	292.190.40H
	190	30	2/7/42	40	2,6	1,6	15°	15° ATB	292.190.40M
	190	30	2/7/42	64	2,6	1,6	15°	15° ATB	292.190.64M
	190	20 (Festool® FF)	5/7/2,5	48	2,4	1,6	10°	15° ATB	292.190.48FF
	200	30	2/7/42	48	2,8	1,8	15°	15° ATB	292.200.48M
	210	25		48	2,8	1,8	15°	15° ATB	292.210.48L
	210	30	2/7/42	48	2,8	1,8	15°	15° ATB	292.210.48M
	210	30	2/7/42	64	2,8	1,8	15°	15° ATB	292.210.64M
	216	30		64	2,8	1,8	-5° Neg.	15° ATB	292.216.64M
NEW	216	30		80	2,8	1,8	-5° Neg.	15° ATB	292.216.80M
	220	30	2/7/42	48	2,8	1,8	15°	15° ATB	292.220.48M
	225	30	2/7/42	48	2,8	1,8	10°	15° ATB	292.225.48M
	230	30	2/7/42	48	2,8	1,8	15°	15° ATB	292.230.48M
	230	30	2/7/42+2/10/60	64	2,8	1,8	15°	15° ATB	292.230.64M
	235	25		48	2,8	1,8	15°	15° ATB	292.235.48L
	235	30	2/7/42	48	2,8	1,8	15°	15° ATB	292.235.48M
	240	30	2/7/42	48	2,8	1,8	15°	15° ATB	292.240.48M
	250	30	COMBI3	60	3,2	2,2	10°	15° ATB	285.060.10M*
	260	30	2/10/60 + 2/7/42	60	2,8	1,8	10°	15° ATB	285.060.11M*

* Industrial quality

Precision dado

230 CMT thoroughly researched the shortcomings of "standard" dado sets and learned what cabinet makers required most from an "ideal" dado.

The result was the superior CMT precision dado, designed with the following features:

- anti-kickback design to reduce the possibility of overfeeding that can occur when cutting mass material.
- splinter resistant cuts in veneer plywood, melamine and hard and soft woods;
- shim sets included for cuts between 6,35mm (1/4") and 22,23mm (7/8").

Precise cuts for accurate fitting dado-groove joints.

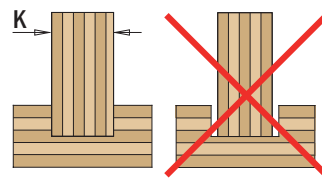

Set includes:

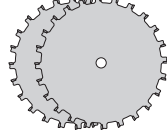

2 BLADES

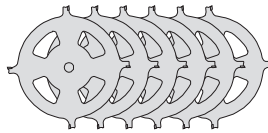

6 CARBIDE TIPPED FOUR TOOTH CHIPPERS

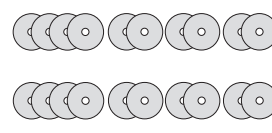

STEEL SHIM SET

Shims set contains	
No.	Shim Width
4	0.1mm
2	0.2mm
2	0.3mm
2	0.5mm

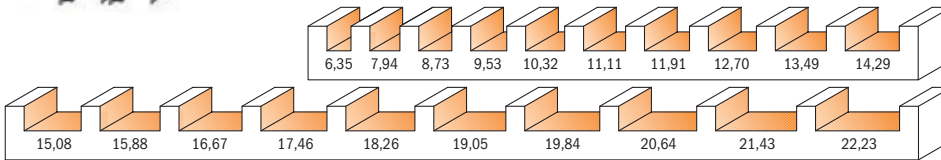

K mm	Number of required inside blades		
	1,6mm	2,4mm	3,2mm
6,35	0	0	0
7,94	1	0	0
8,73	0	1	0
9,53	0	0	1
10,32	1	1	0
11,11	1	0	1
11,91	0	1	1
12,70	0	0	2
13,49	1	1	1
14,29	1	0	2
15,08	0	1	2
15,88	0	0	3
16,67	1	1	2
17,46	1	0	3
18,26	0	1	3
19,05	0	0	4
19,84	1	1	3
20,64	1	0	4
21,43	0	1	4
22,23	1	1	4

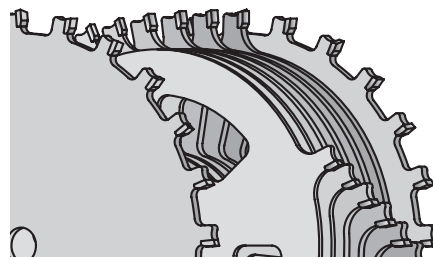
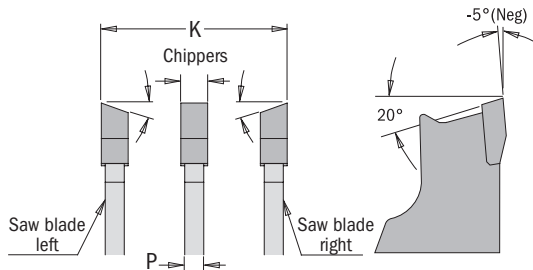

D mm	B mm	Z	P (inside blades)			K min.	K max.	α	β	ORDER NO.
			3,2mm	2,4mm	1,6mm					
150	15,87	20	4 pcs.	1 pcs.	1 pcs.	6,35	22,23	-5°	FTG+ATB	230.520.06
200	15,87	24	4 pcs.	1 pcs.	1 pcs.	6,35	22,23	-5°	FTG+ATB	230.524.08
200	30	24	4 pcs.	1 pcs.	1 pcs.	6,35	22,23	-5°	FTG+ATB	230.524.08M



Set includes:

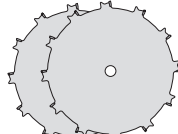

2 BLADES

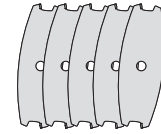

5 CARBIDE TIPPED TWO TOOTH CHIPPERS

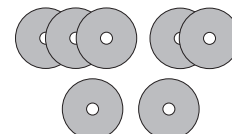

STEEL SHIM SET

Shims set contains	
No.	Shim Width
3	0.1mm
2	0.2mm
1	0.3mm
1	0.5mm

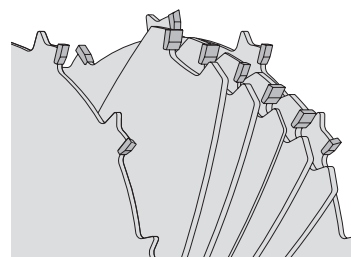
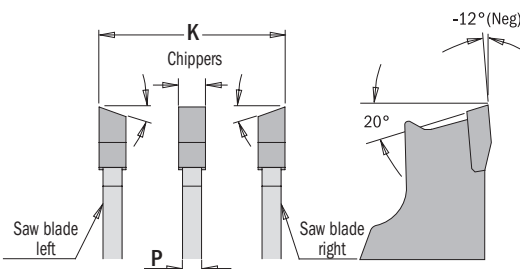
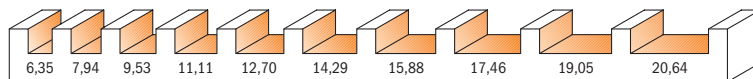

D mm	B mm	Z	P (inside blades)		K min.	K max.	α	β	ORDER NO.
			3,2mm	1,6mm					
200	15,87	12	4 pcs.	1 pcs.	6,35	20,64	-12°	FTG+ATB	230.012.08

K mm	Number of required inside blades	
	1,6mm	3,2mm
6,35	0	0
7,94	1	0
9,53	0	1
11,11	1	1
12,70	0	2
14,29	1	2
15,88	0	3
17,46	1	3
19,05	0	4
20,64	1	4

Grooving saw blades *industrial line***240****APPLICATION:** for grooving cuts or for rebating, chamfering, grooving and profiling as a set of tools.**MACHINES:** **double-end tenoner and** moulding machines.**MATERIAL:** soft and hardwood, wood-based panels, plastic.

	ISO:	K01
	HV10:	1.840
	N/mm²:	2.050

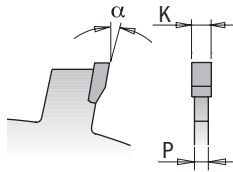
*The new design allows multi-rip grooves using different kerf thickness.*

D mm	B mm	Z	K mm	P mm	α	β	ORDER NO.
150	30	12	2,0	1,4	15°	FLAT	240.020.06M
150	35	12	2,0	1,4	15°	FLAT	240.020.06R
150	30	12	3,0	2,0	15°	FLAT	240.030.06M
150	35	12	3,0	2,0	15°	FLAT	240.030.06R
150	30	12	4,0	3,0	15°	FLAT	240.040.06M
150	35	12	4,0	3,0	15°	FLAT	240.040.06R
150	30	12	5,0	3,0	15°	FLAT	240.050.06M
150	35	12	5,0	3,0	15°	FLAT	240.050.06R
150	30	12	6,0	3,0	15°	FLAT	240.060.06M
150	35	12	6,0	3,0	15°	FLAT	240.060.06R
180	30	18	3,0	2,0	15°	FLAT	240.030.07M
180	35	18	3,0	2,0	15°	FLAT	240.030.07R
180	30	18	4,0	3,0	15°	FLAT	240.040.07M
180	35	18	4,0	3,0	15°	FLAT	240.040.07R
180	30	18	5,0	3,0	15°	FLAT	240.050.07M
180	35	18	5,0	3,0	15°	FLAT	240.050.07R
180	30	18	6,0	3,0	15°	FLAT	240.060.07M
180	35	18	6,0	3,0	15°	FLAT	240.060.07R

Biscuit joiner saw blades

**240-241**

CMT's 100mm biscuit joiner saw blades with orange PTFE industrial coating trademark make biscuit joints quickly and easily. High-grade German steel and 8 micrograin carbide-tipped teeth guarantee years of use. These blades fit Lamello, Dewalt, Porter-Cable, Skil, Bosch, Freud and other popular biscuit joints models.

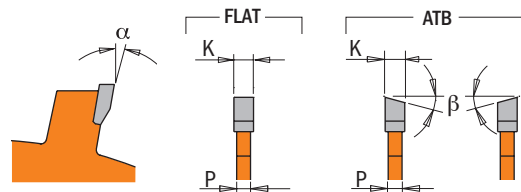

D mm	B mm	Pin Hole 	Z	K mm	P mm	α	β	ORDER NO.
100	22	4/4,5 - 9,5/36	6	3,96	3,0	18°	10° ATB	240.006.04
100	22	4/4,5 - 9,5/36	8	3,96	3,0	15°	10° ATB	240.008.04
100*	22	-	8	3,96	3,1-3,9	15°	FLAT	241.008.04

* For Virutex, Porter-Cable machines

Mini-spot circular saw blade for Lamello



240.004.04

The new CMT mini-spot saw blade is ideal for any type of repairing on solid wood. Resin, knots and other wood flaws are no longer a problem. Thanks to this product and original patches the cut points will be covered up perfectly. After repairing, the patches will practically be invisible, because the wood and patches grains will match in the same direction. For use with Lamello or other machines.

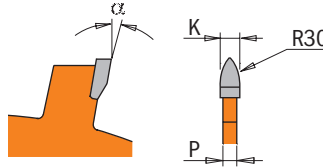

D mm	B mm	Z	K mm	P mm	α	β	ORDER NO.
100	22	4	8,0	6,0	18°	R30	240.004.04

Balance blade & sanding disks



299.11

Before starting a saw project, balance your CMT blade in your table saw with the CMT balance blade and sanding disk. Mount the balance blade in your table saw and line it up with a square for accuracy. Remove the balance blade and mount your saw blade for true and precise cuts. You can also use the balance blade as a sander by attaching a self-stick sandpaper.



D mm	B mm	P mm	ORDER NO.
200	15,87	2,8	299.111.00
200	30	2,8	299.111.00M
250	15,87	2,8	299.112.00
250	30	2,8	299.112.00M

Saw blades stabilizers



299.10

The CMT blade stabilizer virtually eliminates rim vibration to make cleaner, straighter cuts and extend the life of your CMT saw blade. It also helps eliminate distracting noise caused by vibration during cutting.

NOTE: use on stationary saws only. Each order includes 2 stabilizers.



DESCRIPTION	D mm	B mm	P mm	ORDER NO.
Stabilizer (2 pcs.) for Ø200mm	75	15,87	3,0	299.101.00
Stabilizer (2 pcs.) for Ø200mm	75	30	3,0	299.101.00M
Stabilizer (2 pcs.) for Ø250mm	125	15,87	3,0	299.102.00
Stabilizer (2 pcs.) for Ø250mm	125	30	3,0	299.102.00M
Stabilizer (2 pcs.) for Ø300mm	152	25,4	3,0	299.103.00
Stabilizer (2 pcs.) for Ø300mm	152	30	3,0	299.103.00M

Reduction rings for saw blades

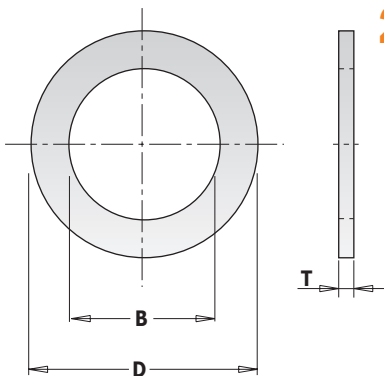

299

D mm	B mm	T mm	ORDER NO.	D mm	B mm	T mm	ORDER NO.
15,87	10	1,2	299.218.00	30	15	1,4	299.240.00 <small>new</small>
15,87	12,7	1,2	299.217.00	30	15,87	1,4	299.211.00
20	12,7	1,2	299.221.00	30	16	1,4	299.223.00
20	16	1,2	299.222.00	30	16	2,0	299.226.00
20	18	1,4	299.236.00	30	18	1,4	299.232.00
<small>new</small> 22,2	15	1,4	299.237.00	30	19,05	1,4	299.241.00 <small>new</small>
<small>new</small> 22,2	16	1,4	299.242.00	30	20	1,4	299.224.00
<small>new</small> 22,2	20	1,4	299.238.00	30	22	1,4	299.231.00
25,4	15,87	1,4	299.216.00	30	20	2,0	299.227.00
25,4	19,05	1,4	299.213.00	30	25	1,4	299.225.00
25,4	20	1,4	299.214.00	30	25	2,0	299.228.00
<small>new</small> 25,4	20	2,3	299.220.00	30	25,4	2,0	299.212.00
25,4	22	1,4	299.215.00	32	30	2,0	299.229.00
<small>new</small> 25,4	22,2	1,4	299.239.00	35	30	2,0	299.230.00
<small>new</small> 25,4	22,2	2,3	299.219.00	35	32	2,0	299.233.00

Saw blades for portable machines

MACHINE	DxB mm
AEG	
HK 125	120x20
HK 125 A, HK 125 B, HK 125 H	125x20
TKS 42, PC 300	132x20
HK 40, TK 40, TKS 42	140x20
HK 86, HK 707	143x19
HK 45, HK 717, HK 727	150x19
AHK 52, HK 45 A, HK 46, HK 46 S, HK 46 N,	150x20
HKS 46, HKS 46 S, HKS 46 N, HK 50,	
HK 52, HKS 52, HK 737	
HK 55, HK 55 A, HK 55 B, HKS 55,	160x20
HK 160 A, HK 160B, KS 55 S, KS 55 SE	
HKS 64 A, HK 65, HK 65 A, HKS 65,	190x30
HKS 65 A, HK 66, HKE 66, HKS 66,	
HKSE 66, HK 190, K 66, K 66 E, K 66 S,	
K 66 SE, KS 65, KS 66 S	
HK 200	200x25
HK 201	200x30
HK 75, HK 75 A, HKS 75	210x30
HKS 35, HKS 85	230x30
HK 240	240x30
MK 65	280x30
ALKO	
Basic 205 GK	205x18
Pro 250 GK	250x20
Basic, HS 3, HS 4, Hobby, Holzmeister H,	315x30
Holzmeister S, Holzmeister NHS, Pro-X	
W 450, W 500 450x30	
W 50 Profi, W 450, W 500	500x30
RM 60, W 60	600x30
RM 70, RZ 70, TWM 70, TWZ 700, W 70	700x30
ALPHA-TOOLS	
KS 250	205x18
ATIKA	
Toptronic	250x30
ATK 315 H, BTA 90, HAT 315	315x30
ABH 400, ABK 400, BTH 400, BTK 400	400x30
ABH 450, ABK 450, ATU 450,	450x30
BTH 450, BTK 450, BTU 450, BWK 450	
ABH 500, ABK 500, BTH 500,	500x30
BTK 500, BTU 500, BWK 500	
AVOLA	
LH 315, TZV 315, TVZ 315 W	315x30
TZH 350, TZH 350 W 350 30, ZB 400,	450x30
ZBV 400 400 30IC 450, ZB 450, ZBV 450	
ZB 500, ZBV 500	500x30
BWS 550	550x30
KWK 600, RK 600	600x30
BWS 700, BWTS 700, KWK 700	700x30
BLACK & DECKER	
D 984, D 985, DN 55, DN 56,	125x12,75
DN 254, DN 984, DN 985	
KC 1440 SK	136x10
BD 227, BD 228, BD 846, CD 600, DN 227,	140x12,75
DN 227 H, KS 40, KS 227, KS 840, KS 846,	
P 3501	
P 88-09 (Akku, 12 V)	150x20
BD 228, BD 228 CK, BD 228 L,	156x12,75
DN 57, DN 228, SR 352, SR 352 E, P 3601	
BD 855, GKS 54 CE, KS 55, KS 855, KS 855 N,	160x16
M 336, M 975, M 976.U 336, U 975, U 976	
BD 229, BD 865, BD 865 E, DN 59, DN 229,	180x16
DN 228, GD 60, HD 100, HD 1000,	
HD 1200 P, HD 2062, KS 65 K, KS 865, KS	
865 E, KS 865 KN, SEC 718, SR	
300, SR 362 E, P 37-03, P 37-05	
HD 1200	180x20
BD 365	190x30
M 338, U 338	200x16
BD 88, BD 800, DN 800,	210x30
DN 810, HD 2075 S HD 20755,	
KS 800, KS 805, KS 810, KS 810 A,	
P 38-02, PS 174, SEC 818, SR 700	
BOSCH	
GUF 4-22 A, PSF 22 (Schatten-fugensäge)	105x20
PKS 38, PKS 40, PKS 40 S, S 43	130x16
1551, 1559	140x20
GKS 12 V, GKS 46, PKS 46,	150x16
PKS 416, PKS 48, S 1, S 33	
GKS 24 V, GKS 54, GKS 54 C,	160x16
GKS 54 CE, GKS 54 E, GKS 59,	
KS 550, PKS 54, PKS 54 CE	
1552, 1556, 1563, GKS 55	170x30
0550, 1550, 1553, 1557, 1560	180x30
P 300, PKS 65	190x16
0051, 1553, 1564, GKS 65, GKS 66,	190x30
GKS 66 CE, GKS 68 B, GKS 68 BC,	
GKS 68 CE, P 30, PKS 66, PKS 66 CE	
0551, 1561	200x30
1554, 1558, 1565, 1588, GKS 72 S	210x30
GCM 8 S	216x30
0052, 0552, 1562, 1566, 1662, GKS 85 S	230x30
1555	240x30
GCM 10, GCM 10 S, GCM 10	250x30
SD, GTS 10	250x30
GCM 12, GCM 12 S	305x30

MACHINE	DxB mm
CASAIS	
SC 650	150x20
VSC 65	200x30
HKS 2000	210x30
SC 320	230x30
DEWALT	
DW 935 K, DW 936 K	136x10
DW 351	150x20
DW 007 K, DW 007 KH	165x10
DC 390 KA, DC 390 KA/3, DC 390 KB	165x20
DW 62	184x16
DW 365	190x30
DW 700, DW 701, DW 707	216x30
DW 383	235x30
DW 86	240x30
DW 100, DW 110, DW 111	250x16
DW 120, DW 125, DW 150, DW 170, DW 250,	250x30
DW 252, DW 320, DW 702, DW 703, DW 710,	
DW 742, DW 743, DW 744, DW 720 K,	
DW 746 K, DW 1251, DW 1370, DW 1501,	
DW 1503	
DW 709, DW 711	260x30
DW 721, DW 722 K, DW 725 K, DW 726 K,	300x30
DW 810, DW1370, DW 1935/31L, 142 DS,	
160 DS, 1635, 1875, 2155	
MC 20	300x32
DW 704, DW 705, DW 706,	305x30
DW 708, D 27105	350x30
DW 728 K, DW 729 K, 1600 S, C 14	
C 14, 1600 S, 1635 GL, 2155 G	400x30
6 K, 6 L, DA 1635	500x30
EINHELL	
BT-CS 1200, HES 55, HES 160	160x20
RT-CS 165	165x16
BHS 1300	184x16
BT-CS 1400	190x20
RT-CS 190 L	190x30
BT-TS 800	200x16
HES 200	200x30
RT-TS 920	205x16
RT-FF 1220 U	205x30
BT-MS 210, BT-SM 2050, KGST	210x30
210, RT-SM 305 L, RT-TS 1221	
KGST 500	250x20
BT-MS 250 L, BT-SM 3100,	250x30
BT-TS 1500 U, KGS 250, KGS, 300 UG,	
KGS 301, KGS 330, KGTN 245, KGTN 250,	
RT-SM 430 U, RT-TS, 1725 U, RT-TS 1825 U,	
RT-UD, 1825, RT-UD 1825, RT-XM 305 U	
RT-SM 330 U	305x30
RT-CC 315 U, RT-TS 2031 U, RT-TS 2231 DU	215x30
BT-LC 400/1	400x30
BT-LC 500	450x30
BT-LC 700 D	700x30
ELEKTRA BECKUM	
Multi 180	200x30
KS 205	205x18
KS 210, GKS 255, P200, PK 200,	210x30
PK 220, UK 220 W, UK 220 E	
Secanta	220x30
PK 250, PK 255, KGT 500, KGS	250x20
300, KGT 550, UK 330, KS 250	
KGS 250, KGS 250 K, KGS 300, KGS 301,	250x30
KGS 303, KGS 330, KGS 331, KGT 250,	
KGT 500, KGT 501, KGT 550, KS 250, KS	
304, Multi 260, Multi 310, PK 250,	
PK 255, PK 2800, PK 3100, PK	
4200, PK 6000, PKF 255, UK250, UK 330	
PK 300, PK 300 K, PKV 300 G	300x30
KS 304	304x30
1800, 2200, 2800, 3100, 4100,	315x30
Combi und Standard HS 315,	
Combi HSG, TKHS 315, TK, HS 315 E	
TK 350	350x30
BKH 400, BKS 400, BKS 450,	400x30
BS 3100 W, BS 4200, BS 5500 W	
BKH 450, BKS 450, BS 6000 D,	450x30
BS 8000 D	
BKH 450, BS 6000 D, BS 8000 D	500x30
BW 400, BW 600, BW 700	600x30
BW 700, BW 750, BW 4000	700x30
ELU/DEWALT	
MKK 26	86x12
MH 25, MH 25 K	100x12
DS 140 Double Schatten-fugensäge	105x22
MHA 14 KA, MHA 18 KA	136x10
MH 151, MH 151/10, MHA 151	150x20
MH 18, MH 30, MH 82, MH 182, PS 174	150x30
MH 55, MH 155	170x30
MH 65	180x30
MH 165, MH 265	190x30
MH 30, MH 82, MH 182	230x30
ETS 41, PS 174, PS 274, PS 244 E	216x30
MH 85, MH 286	240x30

MACHINE	DxB mm
ELU/DEWALT (vervolg)	
ETS 21, ETS 23, ETS 31, ETS 33, KSU 101,	250x30
RAS 1251, RAS 1253, RKS 1251, RKS 1253,	
TGS 71, TGS 170, TGS 171, TGS 172,	
TGS 173, TGS 271, TGS 273	
EMTS 711	260x30
ETS 3001, ETS 3003, PS 374	300x30
EMS 705, PS 374	305x30
RKS 1603	350x30
MTS 24	355x25,4
RSA 133/25	500x30
ELUMATEC	
KS 101, MGS 460	254x32
DG 163, RS 160, TS 161	280x32
KS 101, MGS 460	300x32
MGS 72/04, MGS 73/23	330x32
DG 79/03-05, DG 79/50, SA 73/25	330x32
DG 79/30-32, DG 79/51, MGS	380x32
72/30, MGS 73/33, SA 73/35	
DG 102, DG 104, DG 140, MGS	420x30
105, MGS 461, SA 103/25	
DG 142, MGS 142, SA 142	500x30
DG 204, DG 240, MGS 205	550x30
EMCO	
Universal	200x15
Rex 2000, Super 1011	250x20
KS 80, MK 81	250x30
EUMENIA	
ML 50 L	220x30
FEIN	
SSK 646, SSL 646	150x20
SSK 660	160x20
SSK 661	210x30
FELDER	
KF 700	250x30
BF 6-26, BF 6-31, BF 6-41,	315x30
BF 31, K 37, KFS 37	
FELISATTI	
TP 751	150x20
TP 756	160x20
TP 765	190x20
TP 781	230x30
T 84, T 85, T 87, T 770, T 771,	250x20
T 777, T 777 B, T 777 CE, T 778, T 867 GS	
M 74, M 75, M 76, M 77, T 84,	250x30
T 85, T 87, T 88	
T 82, T 83, T 91, T 91 CE, T 97 CE	300x30
FERM	
FZT 250, FZT 250 EN	250x30
FESTOOL	
AUF 35-S3, AUF 35-S4	105x20
AUF 35-S2	120x20
AF 45 E, AXF 45	150x30
AP 55, AP 55 E, AP 55 E-FS, AP 55 FS,	160x20
ATF 55, ATF 55 E, ATF 55 EB, ATF 55 E-FS,	
ATF 55 FS, AP 55 EB, TS 55, TS 55	
EQ, TS 55 EBQ, TS 55 Q	
AAU, AU 50, AUP 50	160x30
AM 42 A, AM 42 S, AM 42 T, AMT 42 S,	170x33
AT 55 B, AT 55 C, AT 55 E, ATU 42-S,	
AU 42 S, AUT 42 S, AXT 50 LA, AXT 55	
AU 55 S, AU 60 P, AU 60 S, A	180x30
UP 60 S, AUT 60 S	
AP 65, AP 65 E, AP 65 E-FS, AP 65 EB,	190x30
AP 65 EB-FS, AT 65, AT 65 E, AT 65 E-FS,	
AT 65 EB, AT 65 EB-FS	
AD 65, AP 68 E, AP 65 S, AU 65 S,	200x30
AUP 65 S, AUT 65 S, AXP 65, AXP 200	
TS 75, TS 75 EBQ, TS 75	210x30
EBQ-FS, TS 75 EQ	
Symmetric SYM 70	216x30
AU 77 S	220x30
CS 70, CS 70 EB	225x30
AU 80 S	230x30
AP 85, AP 85 E, AP 85 E-FS, AP 85 E-TS,	240x30
AP 85 EB, AP 88, AP 88 E, AXP 85	
AD 85, AD 100, AE 85, AE 88	250x30
Kapex KS 88, Kapex KS 120	260x30
AXP 130, AXP 132 E, BD 125	330x30
BD 145, BD 145/1	400x30
BD 170	450x30
FEZER	
KG 20	200x18
KG 205	205x18
KG 25	250x32
KG 30	300x32
KG 40 S	400x32
AB 600	600x32
FLOTT/FLOTTJET/KRAKU	
1000, 2000, Profi 3000	250x20
KS 1011, TKS 2011 D, TKS 2011 W,	250x30
KS 2011 D, KS 2011 W, KS 2012, 3011,	
Profi 2000, Profi 2001,	
Profi 3011, Uni-Profi 2011	
FKS 3000, KKS 305 M	315x30

Saw blades for portable machines

MACHINE	DxB mm
GRAULE	
AKF F, AKF 4/200	200x40
AKF 2, AKF 4/250, AKF 6/250, KS, TS	250x40
85 N, AGL, AGT, AKF 6/300, Typ 85, ZS 85	300x40
Typ 135, ZS 135, ZS 135 N	350x40
Typ 170, ZS 170, ZS 170 N	420x40
ZS 200	520x50
GIUDE	
GTK 721	205x18
GTK 800	205x20
GKS 1100 P, GRK 210/300,	210x30
GUKS 2100, KT 210	
GFO 1401	216x30
GKS 250 L, GKS 250 T, GRK	250x20
250/300, GRK 250/500	
TK 2500 UG, GFO 1801	254x20
TK 2400 ECO	254x30
GTKS 315	315x30
GWS 400 Eco	400x30
GWS 450 Eco	450x30
FP 600 Plus, GWS 600 EC,	600x30
GWS 600 HM, QWS 600	
DTW 700, DWS 700, DWS 700 Z, GWS 700,	700x30
FP 700 Plus, GWS 700 HM, GWS 700 EC,	
PRS 700/7 HMF, PTW 700/7	
HMF, PWS 700/7 HMF	
HAAGER	
HTK 200	200x30
HKGS 250, HMS 10 RA	250x20
GKS 250 HR, HBTS 10 A	250x30
HTK 300	300x30
HAFFNER	
RF 60	100x20
KSU 40	120x20
KSU 105, KSU 125	125x20
KSU 50	160x20
KSU 110	170x30
KSU 60, KSU 113	180x20
KSU 60 alt	200x30
GL 136	200x20
AKS	210x30
AS 75, KS 75, RS 75	220x30
140, KL 177, KL 178, KSU 118	220x30
HSU 85, KL 176, KS 85, KSU 85,	250x30
SP 187, US 85	
AKS, GS 1, GS 2W, GS 2 D, GS 150, GS 163,	250x30
GS 165, GS 166, KL 140, SP 189, SP 195,	
SP 196, SP 197, SP 198, TGS 161,	
TGS 162, TGS 163, TGS 198	
MK 251 B	300x32
950, GS 146, GS 147, GS 148, GS 155,	330x30
GS 156, GS 157, GS 158, GS 165, GS 166,	
GS 183, GS 183 M, KS 120, KS 155,	
SP 221, SP 223, SP 224, TGS 168, TGS 169,	
TGS 200, TK 42, US 151	
DGS 180, DGS 182, GSM 180, GSA 180	350x30
GS 159, GS 160	340x30
MK 350 Vario	400x32
DGS 123, DGS 124, DGS 180, DGS 181,	500x30
DGS 182, DGS 184, DGS 184 E, DGS 188,	
DGS 185, GS 183, GS 184, GS 188 M,	
GS 188 P, GSA 184 E, KS 155, ZS 640,	
ZS 800	
DGS 187, DGS 202, GS 161,	600x30
GS 162, US 161, US 162 30	
HANNING	
TK 20 N, TK 20 S, TK 200,	200x16
TK 300, ZK 205, HKS 250	250x16
3 VS, HTK 315/1.6, HTK 315/2.1,	315x30
HTK 315/3.0, HTK 315/3 SV, HTK 315/4.0	
HANSEATIC	
PSC 160 D	160x20
HILTI	
WSC 55	160x20
WSC 85	230x30
HERCULES	
KG 205	205x16
TKS 250 UV	250x16
BK 315/1	315x30
HITACHI	
C 5 Y	125x20
C 5, FC 5, FC 5 SA	150x20
C 6, C 6 DA, C 60 A, FC 65 A, FC 6 SA	160x20
C 6 BU, C 6 U, C 6 DD-Akku, FC 6 SB	165x30
C 6 SA, PSU 6	170x30
C 7 U, C 7 BU, FC 7 SA, PSM 7, PSM 7 A,	190x30
PSU 7 C 8 U, C 8 FA, PSM 8, PSU 8	210x30
C 8 FC, C 8 FS	216x30
C 9 U	235x30
PSM 9, PSM 9 A, PSU 9	240x30
U 210	250x30
C 10 FB, C 10 FCA, C 10 FCS, C 10 RA	255x30
C 13 U, PSU 13	335x30
C 15 FC	380x30
HOLZ-HER (REICH)	
Derby 2110, Mosquito 2111, Mosquito 2171	132x30

MACHINE	DxB mm
2260, 2270	140x30
2103, 2104, 2105, 2106, 2107,	160x30
2108, HKU 50	
1563, 2115, 2266, 2271, 2281	170x30
2112, 2272, 2291, HKU 55	180x30
2114, 2116, 2117, 2119, 2126,	190x30
2127, 2269, 2282	
2113, 2292, 2555, HK 201	200x30
2267, 2284, PKS 267	210x30
Leistensäge 2141	216x30
2267, 2274, 2279, 2284, HKU 75, PKS	220x30
2118, 2120, 2171, 2279, 2293, 2294	230x30
2128, 2268, HKD 65	240x30
HKD 85, HKD 275, HKD 1212, PKS 1210,	300x30
PKS 1211, PKS 1213, PKS 1225,	
PKS 1230 303	
HKS 130, HKS 150, HKS 276	350x30
HKS 2136	380x30
HKS 155, HKS 277, HKS B 7 K, BTK 155	400x30
JEPSON	
8219	192x20
9211 D	255x25,4
9312 E, 9430	305x25,4
9314, 9435	355x25,4
KITY	
626	150x20
510, 616, 617, 2617	180x15
0419, 7419, 0618, Kombi 2000,	200x30
Kombi 5023, Junior 6	
618	250x30
1609, 1619, 5619, 6619, 9619 2	70x30
819	315x30
KRESS	
CHKS 6050, CHKS 6055	160x20
CHKS 6060, 1400 HKS, 1500 KS, 1800 KSE	190x20
MAFFEL	
A 35, FS 35, KSS 300, KSP 40	120x20
SF 32, X 40, XE 40	125x20
A 55, B 55, FU 50, KSP 55, KSP 55 F,	160x20
KSS 330, KSS 400, KST 55, MKS 55, MS 55,	
MT 55, PS 52, PSS 3000, PS 3100, X 55,	
XE 55	
KS 320	160x30
Erika 55	180x30
Erika 60, KSP 65, KSP 65 F, MS 65, MKS 65	190x30
B 65, X 72	200x30
AS 65, FUS 65	210x20
MS 75, MKS 75	210x20
Erika 70 E, MKS 85	225x20
KSP 85, KSP 85 FC	230x30
B 82	240x30
Erika 85, MS 85, MKS 85, MKS 85 S	250x30
A 85, Erika 65, FS 65, FU 585, FUS 85	280x30
Erika 70 L, Erika 70 K	290x20
Biberex, MKS 105, Monika,	315x30
TFK 85 L, TFK 85 K	
Biber, FS 85	325x30
MKS 130 EC	330x30
MKS 125, MKS 125 E	355x30
MKS 145, MKS 145 EC	370x30
BK 3, BKS 4, FS 130, FS 130 S, TD 3, VKS 1	400x30
MKS 165, MKS 165 EC, FS 130K	410x30
TDH 4, TDH 425	425x30
BK 4, BKV 4, BKS 5, FSG 165,	450x30
MKS 185 EC, TDH 5, TDH 450	
BKV 5, BKS 6, TDH 5-170	500x30
FSG 200	550x30
FSG 240 K	640x30
MAKITA	
4341 S, BTK 0, KS 0852 S, 61+2, 52 S	150x20
5600 NB, 5600 RDW	160x20
167, 0846 S, 0946 S, 5600 BR, 5603 R,	165x20
5604 R, TK 1256, KS 1155, KST 1157 S,	
KSTE 1357, S-Signal, SBTk 1, SR 1600	
5500 S, 5800 B, 5801 B, 6317 S	180x20
5800 BR, SR 1800	185x20
4346 S, KS 65, KS 1266 S, KS	190x20
1468, KS 4345 S, KSE 1668, TK 5348	
5703 R, 5705 R, 5017 RKB	190x30
Radial-Eudora 5700	200x25
LS 0810, SR 2100	210x25
KGS E 1670 S, KSE 1678 S	210x30
6322 S	220x30
SR 2300, SR 5900 B, SR 5900 BR	235x25
5903 R	235x30
KS 1785, KS 6323 S	240x30
LS 1013, LS 1014	260x25
SR 2600	266x25
5103 R, SR 2600	270x30
5100 BR	335x25
5143 R	355x30
METABO	
F 0520	100x22
4340 S, BHK 2, BHK 3, 4345 S 140 20	140x13
4341 S, BTK 0, 61 + 2, KS 52,	150x20
KS 0846 S, KS 0852 S	

MACHINE	DxB mm
BTK 1, KS 1155 S, Magnum, TK 1256	165x20
6317 S	180x20
KS 655, KS 1266, KS 1468 S,	190x20
KS 4345 S, KS 4346 S, KS5348,	
KSE 1668, Robert	
KGSE 1670, KSE 1678 S-Signal,	210x30
Magnum TK 1066, TKU 225	
6322 S	220x30
KS 1785 S, KS 6323 S	240x30
TK 1633, TKU 1633, TKU 1693	250x30
TK 1688, TK 1688 D	315x30
PANASONIC	
EY 3501	110x20
EY 3530	135x20
PERLES	
25 S	100x12
SC 47 C	140x20
KS 50, Peugeot, SC 53 C	150x20
FIP 50 S	180x20
KS 85	230x30
PROTOOL	
CSP 55-2, CSP 56 EQ,	160x20
CSP 56 Q, CSP 68	
CSP 68 E	190x30
CSP 85	240x30
ROBLAND	
K 210 - 260	240x30
X 260	250x30
K 310, X 310	300x30
ROCKWELL	
346, 63416	170x16
315, 4500, 63417	184x16
368, 63418	220x20
SCHEER	
HM 5, HM 6	100x22
MS 50	150x16
MS 45, MS 45 E	150x20
FM	160x16
MS 55	160x20
FM	180x16
MS 65, MKS 65	190x30
MS 70	200x30
MS 80	220x30
MS 85	230x30
FM 10, A 3100, A 4200	240x30
SCHEPPACH	
KG 205	205x18
TS 2000	200x30
Capas 1, Capas 2	216x30
KG 250, TKG 250, TS 2500	250x20
KSE 250, TS 2500, KG 260, TKG	250x30
260, KG 280, TKG 280	
Capas 3, TKG 305 E	305x30
TS 315 GT, TS 400, TS 4010, TKU	315x30
BSH 400	400x30
BSH 500	500x30
SKIL	
22501 B	125
5140 A, 5140 B, 5240	130
532	140
533, 553, 5246, 1800 H, 1850 H	150
416 H, 534, 536, 552 B, 1408 H,	160
1409 H, 1410 H, 1440 H, 5750 A	
77 U, 537 U, 553 B, 553 H,	184
559 U, 574 U, 599 U, 857	
1865, 1866, 5266, 5565, 5566,	190
5666, 5866 A, 1899, 1965 U, 1986	
554 B, 554 H, 825, 858, 1524 H, 1873 H	210
555 H, 1525 H, 1886 H, 1985 U	230
1523 H, 1526 H, 1899 H	260
STAYER	
CP 50	150x20
KS 700, SC 205, TKS 2000	205x18
SC 250, SC 251, SCU 75	250x20
SC 260, SCE 1610, SLL 250	250x30
TD 305	305x25,4
TIP	
HKS 160	160x20
HKS 200	200x16
TKS 250	250x15,8
TGS 250	250x25,4
ULMIA	
1409 B	160x20
1706, 1708	200x16
1710 S, 1710 R	250x15,8
Gecombineerde machines	300x25,4
WEGOMA	
TB 204	105x22
HS 50	150x20
TS 250	250x30
S 4 D, S 4 W	350x30
TS 400	400x30

Saw blade index

D mm	B mm	APPLICATION	Z	K mm	P mm	α	β	ORDER NO.	PAGE
70	20	Panel sizing	8+8	2,8-3,6		15°	FLAT	289.070.16H	21
80	20	Panel sizing	12	3,1-4,0	2,2	10°	CO+FTG	S288.080.12H	21
80	20	Panel sizing	10+10	2,8-3,6		15°	FLAT	289.080.20H	21
100	20	Panel sizing	20	3,1-4,0	2,5	5°	CO+5° ATB	288.100.20H	21
100	22	Panel sizing	20	3,1-4,0	2,5	5°	CO+5° ATB	288.100.20K	21
100	20	Panel sizing	10+10	2,8-3,6		15°	FLAT	289.100.20H	21
100	22	Panel sizing	10+10	2,8-3,6		15°	FLAT	289.100.20K	21
100	22	Grooving	6	3,96	3,0	18°	10°ATB	240.006.04	34
100	22	Grooving	8	3,96	3,0	15°	10°ATB	240.008.04	34
100	22	Grooving	8	3,96	3,1-3,9	15°	FLAT	241.008.04	34
100	22	Grooving	4	8,0	6,0	18°	R30	240.004.04	35
120	20	Two-sided melamine	20	3,1-3,7		5°	CONICAL	238.120.20H	19
120	20	Panel sizing	24	3,1-4,0	2,5	5°	CO+5° ATB	288.120.24H	21
120	20	Panel sizing	24	3,4-4,2	2,5	5°	CO+5° ATB	288.120.24H1	21
120	22	Panel sizing	24	3,1-4,0	2,5	5°	CO+5° ATB	288.120.24K	21
120	20	Panel sizing	12+12	2,8-3,6		15°	FLAT	289.120.24H	21
120	22	Panel sizing	12+12	2,8-3,6		15°	FLAT	289.120.24K	21
120	50	Panel sizing	12+12	2,8-3,6		15°	FLAT	289.120.24T	21
120	20	Panel sizing	24	3,1-4,3	2,2	0°	CO+6° ATB	288.720.24H	22
120	22	Panel sizing	24	3,1-4,3	2,2	0°	CO+6° ATB	288.720.24K	22
120	20	Panel sizing	12+12	2,8-3,6		11°	5° ATB	289.720.24H	22
120	22	Panel sizing	12+12	2,8-3,6		11°	5° ATB	289.720.24K	22
120	20	Aluminium	36	1,8	1,2	-6° Neg.	TCG	296.120.36H	23
120	20	Portables machines	18	1,8	1,2	15°	15° ATB	291.120.18H	31
120	20	Portables machines	36	1,8	1,2	10°	15° ATB	292.120.36H	32
120	20	Portables machines	40	1,8	1,2	10°	15° ATB	292.120.40H	32
125	20	Two-sided melamine	20	3,1-3,7		5°	CONICAL	238.125.20H	19
125	20	Panel sizing	24	3,1-4,0	2,5	5°	CO+5° ATB	288.125.24H	21
125	20	Panel sizing	24	3,4-4,2	2,5	5°	CO+5° ATB	288.125.24H1	21
125	20	Panel sizing	24	4,3-5,5	3,2	10°	CO+FTG	288.125.24H2	21
125	22	Panel sizing	24	3,1-4,0	2,5	5°	CO+5° ATB	288.125.24K	21
125	45	Panel sizing	24	4,3-5,5	3,2	10°	CO+FTG	288.125.24Q	21
125	20	Panel sizing	12+12	2,8-3,6		15°	FLAT	289.125.24H	21
125	22	Panel sizing	12+12	2,8-3,6		15°	FLAT	289.125.24K	21
125	20	Panel sizing	24	3,1-4,3	2,2	0°	CO+6° ATB	288.725.24H	22
125	20	Panel sizing	12+12	2,8-3,6		11°	5° ATB	289.725.24H	22
125	20	Portables machines	20	2,4	1,4	15°	15° ATB	291.125.20H	31
125	20	Portables machines	36	2,4	1,4	15°	15° ATB	292.125.36H	32
130	20	Portables machines	20	2,4	1,4	15°	15° ATB	291.130.20H	31
130	20	Portables machines	36	2,4	1,4	15°	15° ATB	292.130.36H	32
136	20 (+10)	Portables machines	18	1,5	1,0	20°	10° ATB + 8° Shear	271.136.18H	26
136	20 (+10)	Portables machines	36	1,5	1,0	18°	10° ATB + 8° Shear	272.136.36H	27
136,5	10	Metal	30	1,5	1,2	0°	TCG	226.030.05	24
136,5	20	Metal	30	1,5	1,2	0°	TCG	226.030.05H	24
140	16	Panel sizing	24	3,1-4,0	2,2	10°	CO+FTG	Y288.140.24E	21
140	20	Portables machines	20	2,4	1,4	15°	15° ATB	291.140.20H	31
140	20	Portables machines	36	2,4	1,4	15°	15° ATB	292.140.36H	32
150	30	Wood	48	3,2	2,2	5°	15° ATB	285.048.06M	13
150	45	Panel sizing	36	4,3-5,5	3,2	10°	CO+FTG	288.150.36Q	21
150	20 (+16)	Portables machines	24	1,5	1,0	18°	10° ATB + 8° Shear	271.150.24H	26
150	20 (+16)	Portables machines	40	1,5	1,0	16°	10° ATB + 8° Shear	272.150.40H	27
150	20	Portables machines	12	2,4	1,4		10° ATB	290.150.12H	29
150	16	Portables machines	24	2,4	1,4	15°	15° ATB	291.150.24E	31
150	20	Portables machines	24	2,4	1,4	15°	15° ATB	291.150.24H	31
150	20	Portables machines	40	2,4	1,4	15°	15° ATB	292.150.40H	32
150	15,87	Grooving	20	6,35 - 22,23		-5°	FTG+ATB	230.520.06	33
150	30	Grooving	12	2,0	1,4	15°	FLAT	240.020.06M	34
150	35	Grooving	12	2,0	1,4	15°	FLAT	240.020.06R	34
150	30	Grooving	12	3,0	2,0	15°	FLAT	240.030.06M	34
150	35	Grooving	12	3,0	2,0	15°	FLAT	240.030.06R	34
150	30	Grooving	12	4,0	3,0	15°	FLAT	240.040.06M	34
150	35	Grooving	12	4,0	3,0	15°	FLAT	240.040.06R	34
150	30	Grooving	12	5,0	3,0	15°	FLAT	240.050.06M	34
150	35	Grooving	12	5,0	3,0	15°	FLAT	240.050.06R	34
150	30	Grooving	12	6,0	3,0	15°	FLAT	240.060.06M	34
150	35	Grooving	12	6,0	3,0	15°	FLAT	240.060.06R	34
160	20	Wood	48	2,2	1,6	5°	15° ATB	285.160.48H	13
160	20	Two-sided melamine	34	2,6	1,8	10°	HDF	287.034.06H	15
160	20	Portables machines	40	2,2	1,6	10°	TCG	281.160.40H	18

D mm	B mm	APPLICATION	Z	K mm	P mm	α	β	ORDER NO.	PAGE
160	20	Portables machines	40	2,2	1,6	10°	TCG	281.160.40H2	18
160	45	Panel sizing	36	4,3-5,5	3,2	10°	CO+FTG	288.160.36Q	21
160	55	Panel sizing	36	4,3-5,5	3,2	10°	CO+FTG	288.160.360	21
160	55	Panel sizing	36	4,7-6,0	3,5	10°	CO+FTG	Y288.160.3602	21
160	20	Aluminium	24	2,2	1,6	5°	TCG	Y284.160.24H	22
160	20	Aluminium	40	2,2	1,6	-6° Neg.	TCG	296.160.40H	23
160	20	Aluminium	56	2,2	1,6	-6° Neg.	TCG	296.160.56H	23
160	20	Metal	30	2,0	1,6	0°	TCG	226.030.06H	24
160	20	Metal	40	1,8	1,4	10°	TCG	226.540.06H	24
160	20 (+16)	Portables machines	24	1,7	1,1	18°	10° ATB + 8° Shear	271.160.24H	26
160	20 (+16)	Portables machines	40	1,7	1,1	16°	10° ATB + 8° Shear	272.160.40H	27
160	20 (+16)	Portables machines	56	1,7	1,1	12°	10° ATB + 8° Shear	273.160.56H	27
160	16	Portables machines	12	2,2	1,6	20°	10° ATB	290.160.12E	29
160	20	Abrasive materials	4	2,1-2,2	1,6	12°	CONICAL	236.160.04H	29
160	20	Abrasive materials	10	2,1-2,2	1,6	12°	CONICAL	236.160.10H	29
160	20	Portables machines	12	2,2	1,6	20°	10° ATB	290.160.12H	29
160	24	Portables machines	24	2,2	1,4	15°	15° ATB	K16024H-X10	30
160	40	Portables machines	40	2,2	1,4	15°	15° ATB	K16040H-X10	30
160	16	Portables machines	24	2,2	1,6	15°	15° ATB	291.160.24E	31
160	20	Portables machines	24	2,2	1,6	15°	15° ATB	291.160.24H	31
160	30	Portables machines	24	2,2	1,6	15°	15° ATB	291.160.24M	31
160	16	Portables machines	40	2,2	1,6	10°	15° ATB	292.160.40E	32
160	20	Portables machines	40	2,2	1,6	10°	15° ATB	292.160.40H	32
160	20 (Virutex)	Portables machines	40	2,2	1,6	10°	TCG	281.160.40H	32
160	20	Portables machines	40	2,2	1,6	10°	TCG	281.160.40H2	32
160	30	Portables machines	40	2,2	1,6	10°	15° ATB	292.160.40M	32
160	20	Portables machines	56	2,2	1,6	15°	15° ATB	292.160.56H	32
165	15,87<>	Metal	36	1,5	1,2	0°	TCG	226.036.06	24
165	20	Metal	36	1,5	1,2	0°	TCG	226.036.06H	24
165	20 (+15,87)	Portables machines	24	1,7	1,1	18°	10° ATB + 8° Shear	271.165.24H	26
165	20 (+15,87)	Portables machines	36	1,7	1,1	20°	10° ATB + 8° Shear	272.165.36H	27
165	20	Portables machines	24	2,6	1,6	15°	15° ATB	291.165.24H	31
165	30	Portables machines	24	2,6	1,6	15°	15° ATB	291.165.24M	31
165	20	Portables machines	56	2,2	1,6	15°	15° ATB	292.165.56H	32
165	20	Portables machines	40	2,6	1,6	10°	15° ATB	292.165.40H	32
165	30	Portables machines	40	2,6	1,6	15°	15° ATB	292.165.40M	32
170	30	Portables machines	24	2,6	1,6	20°	10° ATB	291.170.24M	31
170	30	Portables machines	40	2,6	1,6	15°	15° ATB	292.170.40M	32
180	20	Abrasive materials	4	2,1-2,2	1,6	12°	CONICAL	236.180.04H	29
180	40	Multitrip	21+3	2,5	1,8	18°	FLAT	280.021.07S	10
180	30	Wood	56	3,2	2,2	5°	15° ATB	285.056.07M	13
180	20	Panel sizing	36	4,3-5,5	3,2	10°	CO+FTG	Y288.180.36H	21
180	30	Panel sizing	36	4,3-5,5	3,2	10°	CO+FTG	288.180.36M	21
180	45	Panel sizing	36	4,7-6,0	3,5	10°	CO+FTG	288.180.36Q	21
180	55	Panel sizing	36	5,0-6,2	3,5	10°	CO+FTG	288.180.360	21
180	50	Panel sizing	44	4,3-5,5	3,2	10°	CO+FTG	288.180.44T	21
180	20	Aluminium	40	2,8	2,2	-6° Neg.	TCG	296.180.40H	23
180	30	Portables machines	12	2,6	1,6	20°	10° ATB	290.180.12M	29
180	20	Portables machines	24	2,6	1,6	20°	10° ATB	291.180.24H	31
180	30	Portables machines	24	2,6	1,6	20°	10° ATB	291.180.24M	31
180	20	Portables machines	40	2,6	1,6	15°	15° ATB	292.180.40H	32
180	30	Portables machines	40	2,6	1,6	15°	15° ATB	292.180.40M	32
180	30	Grooving	18	3,0	2,0	15°	FLAT	240.030.07M	34
180	35	Grooving	18	3,0	2,0	15°	FLAT	240.030.07R	34
180	30	Grooving	18	4,0	3,0	15°	FLAT	240.040.07M	34
180	35	Grooving	18	4,0	3,0	15°	FLAT	240.040.07R	34
180	30	Grooving	18	5,0	3,0	15°	FLAT	240.050.07M	34
180	35	Grooving	18	5,0	3,0	15°	FLAT	240.050.07R	34
180	30	Grooving	18	6,0	3,0	15°	FLAT	240.060.07M	34
180	35	Grooving	18	6,0	3,0	15°	FLAT	240.060.07R	34
184	15,87<>	Abrasive materials	4	1,8	1,4	12°	TCG	236.004.07	29
184	15,87<>	Metal	48	2,0	1,6	0°	TCG	226.048.07	24
184	15,87<>	Metal	48	2,0	1,6	10°	TCG	226.548.07	24
184	20 (+16+15,87)	Portables machines	24	1,7	1,1	20°	10° ATB + 8° Shear	271.184.24H	26
184	30	Portables machines	24	1,7	1,1	20°	10° ATB + 8° Shear	271.184.24M	26
184	20 (+16+15,87)	Portables machines	40	1,7	1,1	18°	10° ATB + 8° Shear	272.184.40H	27
184	30	Portables machines	40	1,7	1,1	18°	10° ATB + 8° Shear	272.184.40M	27
184	15,87 <>	Portables machines	24	1,9	1,2	20°	1FTG+2/20° ATB	250.024.07	28
184	15,87 <>	Portables machines	40	1,9	1,2	20°	1FTG+4/20° ATB	251.040.07	28

Saw blade index

D mm	B mm	APPLICATION	Z	K mm	P mm	α	β	ORDER NO.	PAGE
184	16	Portables machines	24	2,6	1,6	20°	10° ATB	291.184.24E	31
184	30	Portables machines	24	2,6	1,6	20°	10° ATB	291.184.24M	31
184	16	Portables machines	40	2,6	1,6	15°	15° ATB	292.184.40E	32
184	30	Portables machines	40	2,6	1,6	15°	15° ATB	292.184.40M	32
190	30	Abrasive materials	4	2,1-2,2	1,6	12°	CONICAL	236.190.04M	29
190	30	Abrasive materials	12	2,1-2,2	1,6	12°	CONICAL	236.190.12M	29
190	30	Aluminium	30	2,6	2,2	5°	TCG	Y284.190.30M	22
190	30	Aluminium	40	2,8	2,2	-6° Neg.	TCG	296.190.40M	23
190	30	Aluminium	64	2,8	2,2	-6° Neg.	TCG	296.190.64M	23
190	20 (Festool® FF)	Aluminium	64	2,8	2,2	-6° Neg.	TCG	296.190.64FF	23
190	30	Metal	40	2,0	1,6	0°	TCG	226.040.07M	24
190	30	Metal	48	1,8	1,4	10°	TCG	226.548.07M	24
190	30 (+20+16)	Portables machines	24	1,7	1,1	20°	10° ATB + 8° Shear	271.190.24M	26
190	30 (+20+16)	Portables machines	42	1,7	1,1	18°	10° ATB + 8° Shear	272.190.42M	27
190	30 (+20+16)	Portables machines	64	1,7	1,1	15°	10° ATB + 8° Shear	273.190.64M	27
190	16	Portables machines	12	2,6	1,6	20°	10° ATB	290.190.12E	29
190	20	Portables machines	12	2,6	1,6	20°	10° ATB	290.190.12H	29
190	30	Portables machines	12	2,6	1,6	20°	10° ATB	290.190.12M	29
190	24	Portables machines	24	2,2	1,4	20°	10° ATB	K19024M-X10	30
190	16	Portables machines	24	2,6	1,6	20°	10° ATB	291.190.24E	31
190	20	Portables machines	24	2,6	1,6	20°	10° ATB	291.190.24H	31
190	30	Portables machines	24	2,6	1,6	20°	10° ATB	291.190.24M	31
190	20 (Festool® FF)	Portables machines	32	2,6	1,6	10°	10° ATB	291.190.32FF	31
190	16	Portables machines	40	2,6	1,6	15°	15° ATB	292.190.40E	32
190	20	Portables machines	40	2,6	1,6	15°	15° ATB	292.190.40H	32
190	30	Portables machines	40	2,6	1,6	15°	15° ATB	292.190.40M	32
190	30	Portables machines	64	2,6	1,6	15°	15° ATB	292.190.64M	32
190	20 (Festool® FF)	Portables machines	48	2,4	1,6	10°	15° ATB	292.190.48FF	32
200	40	Multirip	21+3	2,5	1,8	18°	FLAT	280.021.08S	10
200	30	Wood	36	3,2	2,2	15°	10° ATB	285.036.08M	12
200	30	Wood	48	3,2	2,2	15°	15° ATB	285.048.08M	12
200	30	Wood	64	3,2	2,2	5°	15° ATB	285.064.08M	13
200	30	Portables machines	64	3,2	2,2	10°	TCG	281.064.08M	18
200	20	Panel sizing	36	4,3-5,5	3,2	10°	CO+FTG	288.200.36H	21
200	45	Panel sizing	36	4,7-6,0	3,5	10°	CO+FTG	288.200.36Q	21
200	45	Panel sizing	36	4,3-5,5	3,2	10°	CO+FTG	Y288.200.36Q2	21
200	65	Panel sizing	36	4,3-5,5	3,2	10°	CO+FTG	288.200.36J	21
200	30	Aluminium	48	2,8	2,2	-6° Neg.	TCG	296.200.48M	23
200	30	Portables machines	36	1,8	1,2	15°	10° ATB + 8° Shear	271.200.36M	26
200	30	Portables machines	48	1,8	1,2	15°	10° ATB + 8° Shear	272.200.48M	27
200	30	Portables machines	24	2,8	1,8	20°	10° ATB	290.200.24M	29
200	30	Portables machines	36	2,8	1,8	15°	15° ATB	291.200.36M	31
200	30	Portables machines	48	2,8	1,8	15°	15° ATB	292.200.48M	32
200	15,87	Grooving	24	6,35 - 22,23		-5°	FTG+ATB	230.524.08	33
200	30	Grooving	24	6,35 - 22,23		-5°	FTG+ATB	230.524.08M	33
200	15,87	Grooving	12	6,35 - 20,64		-12°	FTG+ATB	230.012.08	33
210	30	Aluminium	48	2,8	2,2	-6° Neg.	TCG	296.210.48M	23
210	30	Aluminium	64	2,8	2,2	-6° Neg.	TCG	296.210.64M	23
210	15,87<	Metal	48	2,2	1,8	0°	TCG	226.048.08	24
210	30	Metal	48	2,2	1,8	0°	TCG	226.048.08M	24
210	30 (+25)	Portables machines	36	1,8	1,2	15°	10° ATB + 8° Shear	271.210.36M	26
210	30 (+25)	Portables machines	48	1,8	1,2	15°	10° ATB + 8° Shear	272.210.48M	27
210	30	Portables machines	24	2,8	1,8	20°	10° ATB	290.210.24M	29
210	25	Portables machines	36	2,8	1,8	15°	15° ATB	291.210.36L	31
210	30	Portables machines	36	2,8	1,8	15°	15° ATB	291.210.36M	31
210	25	Portables machines	48	2,8	1,8	15°	15° ATB	292.210.48L	32
210	30	Portables machines	48	2,8	1,8	15°	15° ATB	292.210.48M	32
210	30	Portables machines	64	2,8	1,8	15°	15° ATB	292.210.64M	32
215	50	Panel sizing	42	4,3-5,5	3,2	10°	CO+FTG	288.215.42T	21
216	30	Abrasive materials	14	2,1-2,2	1,6	12°	CONICAL	236.216.14M	29
216	30	Aluminium	64	2,8	2,2	-6° Neg.	TCG	297.064.09M	23
216	30	Metal	48	2,2	1,8	0°	TCG	226.047.09M	24
216	30	Metal	56	1,8	1,4	10°	TCG	226.556.09M	24
216	30	Portables machines	36	1,8	1,2	-5° Neg.	10° ATB + 8° Shear	271.216.36M	26
216	30	Portables machines	48	1,8	1,2	-5° Neg.	10° ATB + 8° Shear	272.216.48M	27
216	30	Portables machines	64	1,8	1,2	-5° Neg.	10° ATB + 8° Shear	273.216.64M	27
216	30	Portables machines	24	2,8	1,8	-5° Neg.	15° ATB	290.216.24M	29
216	24	Portables machines	24	2,4	1,6	-5° Neg.	15° ATB	K21624M-X10	30
216	48	Portables machines	48	2,4	1,6	-5° Neg.	15° ATB	K21648M-X10	30

D mm	B mm	APPLICATION	Z	K mm	P mm	α	β	ORDER NO.	PAGE
216	30	Portables machines	48	2,8	1,8	-5° Neg.	15° ATB	291.216.48M	31
216	30	Portables machines	64	2,8	1,8	-5° Neg.	15° ATB	292.216.64M	32
216	30	Portables machines	80	2,8	1,8	-5° Neg.	15° ATB	292.216.80M	32
220	30	Two-sided melamine	42	3,2	2,2	10°	HDF	287.042.09M	15
220	30	Two-sided melamine	42	3,2	2,2	-6°	HDF	287.043.09M	15
220	30	Two-sided melamine	64	3,2	2,2	-5°	40° ATB	283.064.09M	16
220	30	Portables machines	64	3,2	2,2	10°	TCG	281.064.09M	18
220	30	Two-sided melamine	63	3,2	2,2	-3°	FFT	281.063.09M	18
220	30	Portables machines	24	2,8	1,8	20°	10° ATB	290.220.24M	29
220	30	Portables machines	36	2,8	1,8	15°	15° ATB	291.220.36M	31
220	30	Portables machines	48	2,8	1,8	15°	15° ATB	292.220.48M	32
225	30	Aluminium	64	2,8	2,2	-6° Neg.	TCG	296.225.64M	23
225	30	Portables machines	36	2,8	1,8	20°	15° ATB	291.225.36M	31
225	30	Portables machines	48	2,8	1,8	10°	15° ATB	292.225.48M	32
230	30	Abrasive materials	4	2,1-2,2	1,6	12°	CONICAL	236.230.04M	29
230	30	Aluminium	48	2,8	2,2	-6° Neg.	TCG	296.230.48M	23
230	30	Portables machines	24	2,8	1,8	20°	10° ATB	290.230.24M	29
230	30	Portables machines	36	2,8	1,8	15°	15° ATB	291.230.36M	31
230	30	Portables machines	48	2,8	1,8	15°	15° ATB	292.230.48M	32
230	30	Portables machines	64	2,8	1,8	15°	15° ATB	292.230.64M	32
235	30	Aluminium	48	2,8	2,2	-6° Neg.	TCG	296.235.48M	23
235	30	Metal	48	2,2	1,8	0°	TCG	226.048.09M	24
235	30 (+25)	Portables machines	36	2,4	1,6	18°	10° ATB + 8° Shear	271.235.36M	26
235	30 (+25)	Portables machines	48	2,4	1,6	18°	10° ATB + 8° Shear	272.235.48M	27
235	25	Portables machines	24	2,8	1,8	20°	10° ATB	290.235.24L	29
235	30	Portables machines	24	2,8	1,8	20°	10° ATB	290.235.24M	29
235	25	Portables machines	36	2,8	1,8	15°	15° ATB	291.235.36L	31
235	30	Portables machines	36	2,8	1,8	15°	15° ATB	291.235.36M	31
235	25	Portables machines	48	2,8	1,8	15°	15° ATB	292.235.48L	32
235	30	Portables machines	48	2,8	1,8	15°	15° ATB	292.235.48M	32
240	30	Portables machines	24	2,8	1,8	20°	10° ATB	290.240.24M	29
240	30	Portables machines	36	2,8	1,8	15°	15° ATB	291.240.36M	31
240	30	Portables machines	48	2,8	1,8	15°	15° ATB	292.240.48M	32
250	30	Abrasive materials	16	2,1-2,2	1,6	12°	CONICAL	236.250.16M	29
250	30	Multirip	20+4	3,2	2,2	18°	10° ATB	279.020.10M	9
250	70	Multirip	20+4	3,2	2,2	18°	10° ATB	279.020.10V	9
250	80	Multirip	20+4	3,2	2,2	18°	10° ATB	279.020.10W	9
250	70	Multirip	20+4	2,7	1,8	18°	10° ATB	280.020.10V	10
250	80	Multirip	20+4	2,7	1,8	18°	10° ATB	280.020.10W	10
250	30	Abrasive materials	16	2,8	1,8	15°	5° ATB	286.016.10M	11
250	30	Wood	24	2,8	1,8	20°	10° ATB	290.250.24M	11
250	30	Wood	40	3,2	2,2	15°	10° ATB	285.040.10M	12
250	30	Wood	48	3,2	2,2	15°	10° ATB	285.048.10M	12
250	30	Wood	60	3,2	2,2	10°	15° ATB	285.060.10M	12
250	35	Wood	40	3,2	2,2	15°	10° ATB	285.040.10R	12
250	35	Wood	60	3,2	2,2	10°	15° ATB	285.060.10R	12
250	30	Wood	80	3,2	2,2	5°	15° ATB	285.080.10M	13
250	35	Wood	80	3,2	2,2	5°	15° ATB	285.080.10R	13
250	30	Wood	80	3,0	2,5	10°	20° ATB	285.580.10M	13
250	30	Wood	40	3,2	2,2	15°	10° ATB	285.640.10M	14
250	30	Wood	60	3,2	2,2	10°	15° ATB	285.660.10M	14
250	30	Two-sided melamine	80	3,2	2,2	5°	15° ATB	285.680.10M	14
250	30	Two-sided melamine	80	3,2	2,2	15°	1FTG+4ATB	274.080.10M	15
250	30	Two-sided melamine	48	3,2	2,2	10°	HDF	287.048.10M	15
250	30	Two-sided melamine	48	3,2	2,2	-6°	HDF	287.049.10M	15
250	30	Two-sided melamine	80	3,2	2,2	-2°	40° ATB	283.080.10M	16
250	30	Two-sided melamine	80	3,2	2,2	5°	40° ATB	210.080.10M	16
250	30	Two-sided melamine	80	3,2	2,2	5°	TCG	281.680.10M	17
250	30	Two-sided melamine	78	3,2	2,2	10°	FFT	295.078.10M	17
250	30	Portables machines	60	3,2	2,2	10°	TCG	281.060.10M	18
250	30	Portables machines	80	3,2	2,2	10°	TCG	281.080.10M	18
250	30	Two-sided melamine	60	3,2	2,2	-3°	FFT	281.061.10M	18
250	30	Two-sided melamine	81	3,2	2,2	-3°	FFT	281.081.10M	18
250	30	Two-sided melamine	48	3,2	2,2	10°	45° TCG	237.048.10M	19
250	30	Two-sided melamine	60	3,2	2,2	10°	TCG	281.060.10M	20
250	30	Two-sided melamine	80	3,2	2,2	10°	TCG	281.080.10M	20
250	32	Aluminium	80	3,2	2,5	5°	TCG	284.080.10P	22
250	30	Aluminium	80	3,2	2,5	-6° Neg.	TCG	297.080.10M	23
250	32	Aluminium	80	3,2	2,5	-6° Neg.	TCG	297.080.10P	23

Saw blade index

D mm	B mm	APPLICATION	Z	K mm	P mm	α	β	ORDER NO.	PAGE
250	30	Metal	72	2,2	1,8	10°	8° FWF	226.572.10M	24
250	30	Corian	72	3,2	2,5	0°	MTCG	223.072.10M	25
250	30	Corian	80	2,8	2,2	-3°	MATB	222.080.10M	25
250	30	Portables machines	24	2,4	1,6	20°	10° ATB + 8° Shear	271.250.24M	26
250	30	Portables machines	42	2,4	1,6	18°	10° ATB + 8° Shear	271.250.42M	26
250	30	Portables machines	60	2,4	1,6	15°	10° ATB + 8° Shear	272.250.60M	27
250	30	Portables machines	80	2,4	1,6	12°	10° ATB + 8° Shear	273.250.80M	27
250	30	Portables machines	24	2,8	1,8	20°	10° ATB	290.250.24M	29
250	40	Portables machines	40	2,6	1,8	15°	10° ATB	K25040M-X05	30
250	20	Garden	20	2,2	1,4	15°	10° ATB	298.250.20H	30
250	25,4	Garden	20	2,2	1,4	15°	10° ATB	298.250.20	30
250	20	Portables machines	40	3,2	2,2	15°	10° ATB	285.040.10H	31
250	30	Portables machines	40	3,2	2,2	15°	10° ATB	285.040.10M	31
250	30	Portables machines	60	3,2	2,2	10°	15° ATB	285.060.10M	32
250	20	Wood	40	3,2	2,2	15°	10° ATB	285.040.10H	12
254	15,87	Abrasive materials	6	2,2	1,6	12°	TCG	236.006.10	29
254	30	Wood	48	2,4	1,8	-5° Neg.	15° ATB	294.048.10M	12
254	30	Wood	60	2,4	1,8	-5° Neg.	15° ATB	294.060.10M	12
254	30	Aluminium	80	3,2	2,5	-5° Neg.	TCG	297.081.10M	23
254	15,87	Metal	48	2,2	1,8	0°	8° FWF	226.048.10	24
254	15,87	Metal	60	2,2	1,8	0°	8° FWF	226.060.10	24
254	30	Metal	60	2,2	1,8	0°	8° FWF	226.060.10M	24
254	15,87	Metal	72	2,2	1,8	10°	8° FWF	226.572.10	24
260	30	Wood	48	2,8	1,8	15°	10° ATB	285.048.11M	12
260	30	Wood	60	2,8	1,8	10°	15° ATB	285.060.11M	12
260	30	Wood	60	2,5	1,8	-5° Neg.	15° ATB	294.060.11M	12
260	30	Aluminium	80	2,8	2,2	-6° Neg.	TCG	297.080.11M	23
260	30	Portables machines	48	2,8	1,8	15°	10° ATB	285.048.11M	31
260	30	Portables machines	60	2,8	1,8	10°	15° ATB	285.060.11M	32
270	30	Wood	28	2,8	1,8	20°	10° ATB	290.270.28M	11
270	30	Portables machines	28	2,8	1,8	20°	10° ATB	290.270.28M	29
270	30	Portables machines	42	2,8	1,8	15°	15° ATB	291.270.42M	31
270	30	Wood	42	2,8	1,8	15°	15° ATB	291.270.42M	12
275	20	Wood	42	3,2	2,2	15°	10° ATB	285.042.11H	12
280	30	Aluminium	64	3,2	2,5	-6° Neg.	TCG	297.064.11M	23
280	30	Wood	64	2,8	1,8	10°	15° ATB	295.064.11M	12
300	30	Abrasive materials	20	2,1-2,2	1,6	12°	CONICAL	236.300.20M	29
300	30	Multirip	24+4	3,2	2,2	18°	10° ATB	279.024.12M	9
300	60	Multirip	24+4	3,2	2,2	18°	10° ATB	279.024.12U	9
300	70	Multirip	24+4	3,2	2,2	18°	10° ATB	279.024.12V	9
300	80	Multirip	24+4	3,2	2,2	18°	10° ATB	279.024.12W	9
300	30	Multirip	28	3,2	2,2	18°	10° ATB	278.028.12M	9
300	70	Multirip	28	3,2	2,2	18°	10° ATB	278.028.12V	9
300	70	Multirip	24+4	2,7	1,8	18°	10° ATB	280.024.12V	10
300	80	Multirip	24+4	2,7	1,8	18°	10° ATB	280.024.12W	10
300	30	Multirip	24+4	4,0	2,8	18°	10° ATB	277.024.12M	10
300	70	Multirip	24+4	4,0	2,8	18°	10° ATB	277.024.12V	10
300	80	Multirip	24+4	4,0	2,8	18°	10° ATB	277.024.12W	10
300	30	Abrasive materials	20	2,8	1,8	15°	5° ATB	286.020.12M	11
300	30	Wood	24	3,2	2,2	20°	10° ATB	293.024.12M	11
300	35	Wood	24	3,2	2,2	20°	10° ATB	293.024.12R	11
300	30	Wood	36	3,2	2,2	15°	10° ATB	285.036.12M	12
300	30	Wood	48	3,2	2,2	15°	10° ATB	285.048.12M	12
300	30	Wood	60	3,2	2,2	15°	10° ATB	285.060.12M	12
300	30	Wood	72	3,2	2,2	10°	15° ATB	285.072.12M	12
300	35	Wood	48	3,2	2,2	15°	10° ATB	285.048.12R	12
300	35	Wood	72	3,2	2,2	10°	15° ATB	285.072.12R	12
300	30	Wood	96	3,2	2,2	5°	15° ATB	285.096.12M	13
300	35	Wood	96	3,2	2,2	5°	15° ATB	285.096.12R	13
300	30	Wood	96	3,0	2,5	10°	20° ATB	285.596.12M	13
300	30	Wood	48	3,2	2,2	15°	10° ATB	285.648.12M	14
300	30	Wood	72	3,2	2,2	10°	15° ATB	285.672.12M	14
300	30	Two-sided melamine	96	3,2	2,2	5°	15° ATB	285.696.12M	14
300	30	Two-sided melamine	100	3,2	2,2	15°	1FTG+4ATB	274.100.12M	15
300	30	Two-sided melamine	96	3,2	2,2	2°	40° ATB	283.096.12M	16
300	30	Two-sided melamine	96	3,2	2,2	5°	40° ATB	210.096.12M	16
300	30	Two-sided melamine	72	3,2	2,2	10°	TCG	281.672.12M	17
300	30	Two-sided melamine	96	3,2	2,2	5°	TCG	281.696.12M	17
300	30	Two-sided melamine	96	3,2	2,2	10°	FFT	295.096.12M	17

D mm	B mm	APPLICATION	Z	K mm	P mm	α	β	ORDER NO.	PAGE
300	30	Portables machines	72	3,2	2,2	10°	TCG	281.072.12M	18
300	30	Portables machines	96	3,2	2,2	10°	TCG	281.096.12M	18
300	30	Two-sided melamine	72	3,2	2,2	-3°	FFT	281.073.12M	18
300	30	Two-sided melamine	96	3,2	2,2	-3°	FFT	281.097.12M	18
300	30	Two-sided melamine	60	3,2	2,2	10°	45° TCG	237.060.12M	19
300	30	Two-sided melamine	96	3,2	2,2	15°	45° TCG	237.096.12M	19
300	30	Two-sided melamine	60	4,4	3,2	16°	TCG	282.060.12M	20
300	30	Two-sided melamine	72	3,2	2,2	10°	TCG	281.072.12M	20
300	30	Two-sided melamine	96	3,2	2,2	10°	TCG	281.096.12M	20
300	75	Two-sided melamine	60	4,4	3,2	16°	TCG	282.060.12X	20
300	80	Two-sided melamine	60	4,4	3,2	16°	TCG	282.060.12W	20
300	50	Panel sizing	48	4,3-5,5	3,2	10°	CO+FTG	288.300.48T	21
300	65	Panel sizing	72	4,3-5,5	3,2	10°	CO+FTG	288.300.72J	21
300	32	Aluminium	96	3,2	2,5	5°	TCG	284.096.12P	22
300	30	Aluminium	96	3,2	2,5	-6° Neg.	TCG	297.096.12M	23
300	32	Aluminium	96	3,2	2,5	-6° Neg.	TCG	297.096.12P	23
300	30	Metal	80	2,2	1,8	10°	8° FWF	226.580.12M	24
300	30	Corian	84	3,2	2,5	0°	MTCG	223.084.12M	25
300	30	Corian	96	2,8	2,2	-3°	MATB	222.096.12M	25
300	30	Portables machines	24	2,6	1,8	22°	10° ATB + 8° Shear	271.300.24M	26
300	30	Portables machines	48	2,6	1,8	18°	10° ATB + 8° Shear	271.300.48M	26
300	30	Portables machines	72	2,6	1,8	15°	10° ATB + 8° Shear	272.300.72M	27
300	30	Portables machines	96	2,6	1,8	12°	10° ATB + 8° Shear	273.300.96M	27
300	20	Wood	48	3,2	2,2	15°	10° ATB	285.048.12H	12
303	30	Two-sided melamine	60	3,2	2,2	10°	HDF	287.060.12M	15
303	30	Two-sided melamine	60	3,2	2,2	-6°	HDF	287.061.12M	15
305	25,4	Abrasive materials	8	2,2	1,6	12°	TCG	236.008.12	29
305	30	Wood	28	2,8	1,8	20°	10° ATB	293.028.22M	11
305	30	Wood	72	3,2	2,2	10°	15° ATB	285.072.22M	13
305	30	Wood	72	3,2	2,2	-5° Neg.	15° ATB	294.072.22M	13
305	30	Aluminium	96	3,2	2,5	-6° Neg.	TCG	297.096.13M	23
305	25,4	Metal	60	2,2	1,8	0°	8° FWF	226.060.12	24
305	25,4	Metal	80	2,2	1,8	0°	8° FWF	226.080.12	24
305	30	Metal	80	2,2	1,8	0°	8° FWF	226.080.12M	24
305	25,4	Metal	80	2,2	1,8	10°	8° FWF	226.580.12	24
305	30	Wood	54	2,8	1,8	-5° Neg.	15° ATB	294.054.22M	12
315	30	Abrasive materials	24	3,2	2,2	15°	5° ATB	286.024.13M	11
315	30	Wood	28	3,2	2,2	20°	10° ATB	293.028.12M	11
315	30	Wood	72	3,2	2,2	10°	15° ATB	285.072.13M	13
315	30	Aluminium	96	3,2	2,5	-6° Neg.	TCG	297.096.23M	23
315	30	Wood	36	3,2	1,8	15°	10° ATB	285.036.13M	12
315	30	Wood	54	3,2	2,2	15°	10° ATB	294.054.12M	12
320	65	Two-sided melamine	60	4,4	3,2	16°	TCG	Y282.060.13J	20
330	30	Aluminium	96	3,2	2,5	-6° Neg.	TCG	297.096.33M	23
330	32	Aluminium	96	3,2	2,5	-6° Neg.	TCG	297.096.33P	23
350	30	Multirip	28+4	3,5	2,5	18°	10° ATB	279.028.14M	9
350	60	Multirip	28+4	3,5	2,5	18°	10° ATB	279.028.14U	9
350	70	Multirip	28+4	3,5	2,5	18°	10° ATB	279.028.14V	9
350	80	Multirip	28+4	3,5	2,5	18°	10° ATB	279.028.14W	9
350	30	Multirip	36	3,5	2,5	18°	10° ATB	278.036.14M	9
350	70	Multirip	36	3,5	2,5	18°	10° ATB	278.036.14V	9
350	30	Multirip	24+6	4,2	2,8	18°	10° ATB	277.024.14M	10
350	70	Multirip	24+6	4,2	2,8	18°	10° ATB	277.024.14V	10
350	30	Abrasive materials	24	3,2	2,2	15°	5° ATB	286.024.14M	11
350	30	Wood	28	3,5	2,5	20°	10° ATB	293.028.14M	11
350	35	Wood	28	3,5	2,5	20°	10° ATB	293.028.14R	11
350	30	Wood	54	3,5	2,5	15°	10° ATB	285.054.14M	12
350	30	Wood	72	3,5	2,5	15°	10° ATB	285.072.14M	12
350	30	Wood	84	3,5	2,5	10°	15° ATB	285.084.14M	12
350	35	Wood	54	3,5	2,5	15°	10° ATB	285.054.14R	12
350	35	Wood	84	3,5	2,5	10°	15° ATB	285.084.14R	12
350	30	Wood	108	3,5	2,5	5°	15° ATB	285.108.14M	13
350	35	Wood	108	3,5	2,5	5°	15° ATB	285.108.14R	13
350	30	Wood	54	3,5	2,5	15°	10° ATB	285.654.14M	14
350	30	Wood	84	3,5	2,5	10°	15° ATB	285.684.14M	14
350	30	Two-sided melamine	108	3,5	2,5	5°	15° ATB	285.708.14M	14
350	30	Two-sided melamine	108	3,5	2,5	5°	40° ATB	283.108.14M	16
350	30	Two-sided melamine	108	3,5	2,5	5°	TCG	281.708.14M	17
350	30	Two-sided melamine	108	3,5	2,5	10°	FFT	295.108.14M	17

Saw blade index

D mm	B mm	APPLICATION	Z	K mm	P mm	α	β	ORDER NO.	PAGE
350	30	Portables machines	84	3,5	2,5	10°	TCG	281.084.14M	18
350	30	Portables machines	108	3,5	2,5	10°	TCG	281.108.14M	18
350	30	Two-sided melamine	72	3,5	2,4	15°	45° TCG	237.072.14M	19
350	30	Two-sided melamine	54	4,4	3,2	16°	TCG	282.054.14M	20
350	30	Two-sided melamine	72	4,4	3,2	16°	TCG	282.072.14M	20
350	30	Two-sided melamine	108	3,5	2,5	10°	TCG	281.108.14M	20
350	50	Two-sided melamine	72	4,4	3,2	16°	TCG	282.072.14T	20
350	60	Two-sided melamine	72	4,4	3,2	16°	TCG	Y282.072.14U	20
350	75	Two-sided melamine	54	4,4	3,2	16°	TCG	282.054.14X	20
350	75	Two-sided melamine	72	4,4	3,2	16°	TCG	282.072.14X	20
350	80	Two-sided melamine	54	4,4	3,2	16°	TCG	282.054.14W	20
350	80	Two-sided melamine	72	4,4	3,2	16°	TCG	282.072.14W	20
350	32	Aluminium	92	3,2	2,5	5°	TCG	284.092.14P	22
350	32	Aluminium	108	3,2	2,5	5°	TCG	284.108.14P	22
350	30	Aluminium	108	3,2	2,5	-6° Neg.	TCG	297.108.14M	23
350	32	Aluminium	108	3,2	2,5	-6° Neg.	TCG	297.108.14P	23
355	30	Two-sided melamine	72	4,4	3,2	16°	TCG	S282.03556	20
355	25,4	Metal	72	2,2	1,8	0°	8° FWF	226.072.14	24
355	25,4	Metal	90	2,2	1,8	0°	8° FWF	226.090.14	24
355	30	Metal	90	2,2	1,8	0°	8° FWF	226.090.14M	24
355	25,4	Metal	90	2,2	1,8	10°	8° FWF	226.590.14	24
355	30	Metal	90	2,2	1,8	10°	8° FWF	226.590.14M	24
380	60	Two-sided melamine	72	4,8	3,5	16°	TCG	282.072.15U	20
400	30	Multirip	28+6	4,0	2,8	18°	10° ATB	279.028.16M	9
400	70	Multirip	28+6	4,0	2,8	18°	10° ATB	279.028.16V	9
400	30	Abrasive materials	28	3,2	2,2	15°	5° ATB	286.028.16M	11
400	30	Wood	36	3,5	2,5	20°	10° ATB	285.036.16M	11
400	30	Wood	48	3,5	2,5	20°	10° ATB	285.048.16M	12
400	30	Wood	60	3,5	2,5	10°	15° ATB	285.060.16M	12
400	30	Wood	96	3,5	2,5	10°	15° ATB	285.096.16M	13
400	30	Wood	120	3,5	2,5	10°	15° ATB	285.120.16M	13
400	30	Two-sided melamine	60	4,4	3,2	16°	TCG	282.060.16M	20
400	30	Two-sided melamine	72	4,4	3,2	16°	TCG	282.072.16M	20
400	60	Two-sided melamine	72	4,4	3,2	16°	TCG	282.072.16U	20
400	75	Two-sided melamine	60	4,4	3,2	16°	TCG	282.060.16X	20
400	75	Two-sided melamine	72	4,4	3,2	16°	TCG	282.072.16X	20
400	80	Two-sided melamine	60	4,4	3,2	16°	TCG	282.060.16W	20
400	80	Two-sided melamine	72	4,4	3,2	16°	TCG	282.072.16W	20
400	32	Aluminium	96	3,8	3,2	5°	TCG	284.096.16P	22
400	30	Aluminium	120	3,8	3,2	-6° Neg.	TCG	297.120.16M	23
400	32	Aluminium	108	3,8	3,2	-6° Neg.	TCG	297.108.16P	23
420	32	Aluminium	96	3,8	3,2	5°	TCG	284.096.17P	22
430	75	Two-sided melamine	72	4,4	3,2	16°	TCG	282.072.17X	20
430	80	Two-sided melamine	72	4,4	3,2	16°	TCG	282.072.17W2	20
450	30	Abrasive materials	32	3,8	2,8	15°	5° ATB	286.032.18M	11
450	30	Wood	36	3,8	2,8	20°	10° ATB	285.036.18M	11
450	30	Wood	54	3,8	2,8	15°	15° ATB	285.054.18M	12
450	30	Wood	66	3,8	2,8	10°	15° ATB	285.066.18M	12
450	60	Two-sided melamine	72	4,8	3,5	16°	TCG	282.072.18U	20
450	80	Two-sided melamine	72	4,8	3,5	16°	TCG	282.072.18W2	20
450	32	Aluminium	108	3,8	3,2	5°	TCG	284.108.18P	22
450	30	Aluminium	140	3,8	3,2	-6° Neg.	TCG	Y297.140.18M	23
450	32	Aluminium	108	3,8	3,2	-6° Neg.	TCG	297.108.18P	23
500	30	Abrasive materials	36	3,8	2,8	15°	5° ATB	286.036.20M	11
500	30	Wood	44	4,0	2,8	20°	10° ATB	285.044.20M	11
500	30	Wood	60	3,8	2,8	15°	15° ATB	285.060.20M	12
500	30	Wood	72	3,8	2,8	10°	15° ATB	285.072.20M	12
500	60	Two-sided melamine	72	4,8	3,5	16°	TCG	282.072.20U	20
500	80	Two-sided melamine	72	4,8	3,5	16°	TCG	Y282.072.20W	20
500	32	Aluminium	120	4,0	3,2	5°	TCG	284.120.20P	22
500	32	Aluminium	120	4,0	3,2	-6° Neg.	TCG	297.120.20P	23
550	30	Abrasive materials	40	4,2	3,2	15°	5° ATB	286.040.22M	11
550	30	Wood	60	4,2	3,2	10°	15° ATB	285.060.22M	12
550	30	Wood	96	4,2	3,2	10°	15° ATB	285.096.22M	12
550	100	Two-sided melamine	72	5,2	3,5	16°	TCG	282.072.22A	20
600	30	Abrasive materials	40	4,2	3,2	15°	5° ATB	286.040.24M	11
600	30	Wood	66	4,2	3,2	10°	15° ATB	285.066.24M	12
700	30	Abrasive materials	46	4,4	3,2	15°	5° ATB	286.046.28M	11
700	30	Wood	72	4,4	3,2	10°	15° ATB	285.072.28M	12

QUALITY MATERIALS FOR OUTSTANDING PERFORMANCE

Produced by following state-of-the-art processes and by using high-tech machines, these jig saw blades have been specifically designed for precise cuts on soft & hardwood, plywood, OSB, laminates, plastics, HPL, multiplex panels, metals, ferrous & non-ferrous materials, aluminium, fiberglass and also stainless steel. These are made of three different materials.

What else? Geometry is important!

HCS

HCS (High Carbon Steel)

For use when cutting softwood, wood fiberboard and soft plastic.

BIM

BIM (Bimetal)

Suitable for use in hardwood, abrasive wooden and harder materials such as non-ferrous and ferrous metals. This special bond of HCS and HSS fits the most diverse needs.

Resistant to shank breakage thanks to its flexibility, this material lasts much longer than HCS and HSS.

An excellent value for your money.

HSS

HSS (High Speed Steel)

For use when cutting harder materials, such as metals, aluminium and non-ferrous metals.

MILLED & SIDE SET TEETH

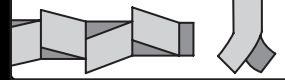

Milled and side set teeth

Jig saw blades featuring this kind of geometry feature a quick rough cut into soft/hardwood, aluminium, plastic and non-ferrous metals.

MILLED & WAVY SET TEETH

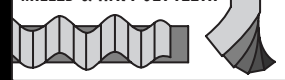

Milled and wavy set teeth

Suitable for fine straight cuts into plywood, soft steel, aluminium, non-ferrous metals and plastic.

GROUND & SIDE SET TEETH

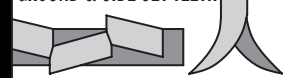

Ground and side set teeth

To be used for quick cuts in wood.

GROUND & TAPER GROUND TEETH



Ground and taper ground teeth

This geometry delivers fine and clear cuts in wood and plastic.



Guide to choosing the most suitable jig saw blade

Serie	Material	Thickness	Line	Fine Straight	Coarse	Fine Curve	Coarse Curve	Pag.		
WOOD	Softwood	1,5-15	Fine			JT101AO		44		
		2-15	Basic			JT119BO		47		
		3-65	Fine, Splinter-Free	JT234X					49	
		3-30	Fine	JT101B					48	
		3-30	Fine, Splinter-Free	JT101BR					48	
		4-60	Basic		JT111C				47	
		5-60	Fast			JT144D		JT244D	47	
		5-100	Fast			JT344D			48	
		7-55	Fine		JT101D				49	
		7-65	Fine		JT301CD				49	
	Hardwood	1,5-15	Fine				JT101AO		48	
		3-30	Fine		JT101B				48	
		3-30	Fine, Splinter-Free		JT101BR				48	
		3-65	Fine, Splinter-Free	JT234X					49	
		5-60	Fast			JT144D		JT244D	47	
		5-100	Fast			JT344D			48	
		7-55	Fine		JT101D				49	
		7-65	Fine		JT301CD				49	
		OSB	2-15	Basic				JT119BO		47
			3-30	Fine		JT101B				48
	4-60		Basic			JT111C			47	
	5-60		Fast			JT144D		JT244D	47	
	7-55		Fine		JT101D				49	
	Plywood	1,5-15	Fine				JT101AO		48	
		2-15	Basic				JT119BO		47	
		3-30	Fine		JT101B				48	
		3-30	Fine, Splinter-Free		JT101BR				48	
		3-65	Fine, Splinter-Free	JT234X					49	
		4-60	Basic			JT111C			47	
		5-60	Fast			JT144D		JT244D	47	
		5-100	Fast			JT344D			48	
	Construction Wood	<30	Fine		JT101B				48	
		3-65	Fine, Splinter-Free	JT234X					49	
		<100	Fast			JT344D			48	
	Chipboard	2-15	Basic				JT119BO		47	
		3-30	Fine		JT101B				48	
		3-65	Fine, Splinter-Free	JT234X					49	
		4-60	Basic			JT111C			47	
		5-60	Fast			JT144D		JT244D	47	
	Laminated panels Kitchen Tops Worktops	1,5-15	Fine				JT101AO		48	
		1,5-15	Fine, Long Life	JT101BIF					49	
		3-30	Fine	JT101B					48	
		3-30	Fine, Splinter-Free	JT101BR					48	
		3-65	Fine, Splinter-Free	JT234X					49	
	METAL	Sheet metals	1-3	Basic	JT118A		JT218A		50	
			1,5-10	Fast, Long life	JT123X				50	
			2,5-6	Basic	JT118B				50	
		Aluminium, non-ferrous	<30	Fast	JT127D					50
			1,5-10	Fast	JT123X					50
		Pipes	<30	Fast	JT123X					50
		Inox Sheets	1,5-3	Fast	JT123X					50
	PLASTIC	GRP (Fiberglass) Plastic (PP, PE, PVC, PA, PS)	<30	Fast	JT127D				50	
			<30	Fine	JT101D				49	
			<30	Fast	JT123X				50	
			7-65	Fine	JT301CD					49

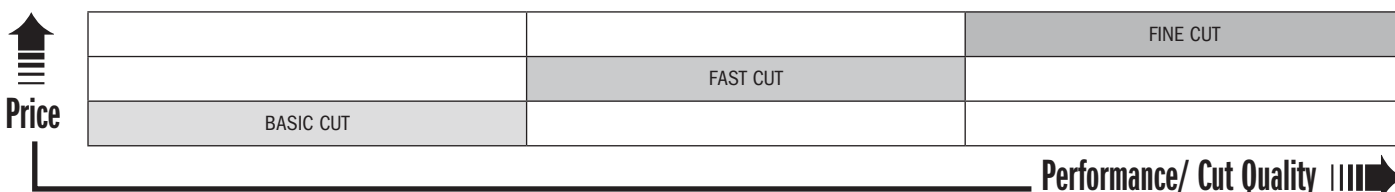



JT119B0

Curve cuts on softwood (2 ~ 15mm), plywood, OSB.

Pack Quantity	I mm	L mm	TS Tooth spacing mm	ORDER NO. T shank
5	50	76	2	JT119B0-5

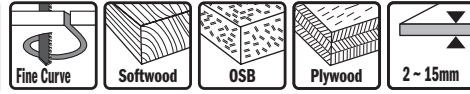

JT111C

Fast coarse cuts on softwood (4 ~ 60mm), plywood, OSB.

Pack Quantity	I mm	L mm	TS Tooth spacing mm	ORDER NO. T shank
5	75	100	3	JT111C-5

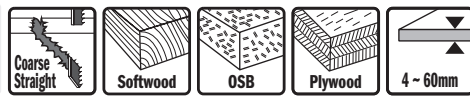

JT144D

Very fast cuts, straight and coarse, on hard/soft woods (5 ~ 60mm), plywood, OSB. Plunge cutting.

Pack Quantity	I mm	L mm	TS Tooth spacing mm	ORDER NO. T shank
5	75	100	4	JT144D-5
25	75	100	4	JT144D-25
100	75	100	4	JT144D-100

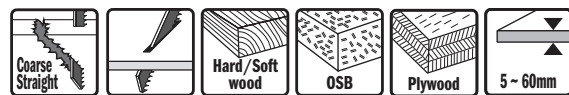

JT244D

Fast, curve, coarse cut on soft and hardwood from 5mm to 60mm, plywood, OSB. Plunge cutting.

Pack Quantity	I mm	L mm	TS Tooth spacing mm	ORDER NO. T shank
5	75	100	4	JT244D-5

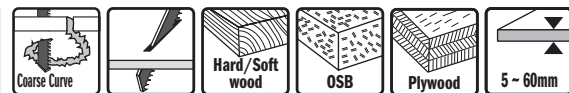

Jig saw blades for wood

new

CMT ORANGE TOOLS™**JT344D**

Very fast cuts, straight and coarse on thick construction timber, hard/soft woods (5 ~ 100mm), plywood, OSB.

Pack Quantity	I mm	L mm	TS Tooth spacing mm	ORDER NO. T shank
5	110	132	4	JT344D-5

**JT101A0**

Curved cuts, fine finishing on both sides of surface on hard/soft woods, plywood, MDF, double sided laminates (1,5 ~ 15mm).

Pack Quantity	I mm	L mm	TS Tooth spacing mm	ORDER NO. T shank
5	50	76	1,4	JT101A0-5

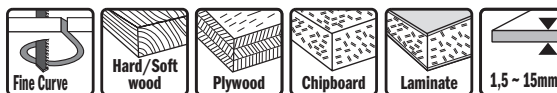
**JT101B**

Fine straight cuts on hard/soft woods, plywood, OSB and plastics (3 ~ 30mm). Plunge cutting.

Pack Quantity	I mm	L mm	TS Tooth spacing mm	ORDER NO. T shank
5	75	100	2,5	JT101B-5
25	75	100	2,5	JT101B-25

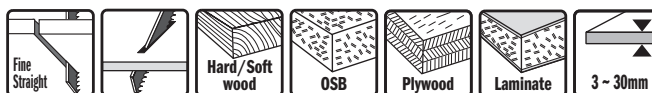
**JT101BR**

Straight cuts, fine finishing on the surface, on hard/soft woods, plywood, OSB, laminated panels, plastics (3 ~ 30mm). Reverse tooth.

Pack Quantity	I mm	L mm	TS Tooth spacing mm	ORDER NO. T shank
5	75	100	2,5	JT101BR-5
25	75	100	2,5	JT101BR-25

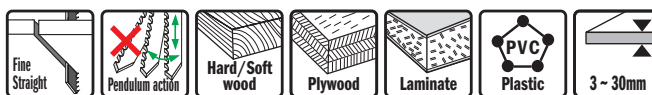



JT101D

Good straight cuts on hard/soft woods, plywood, OSB, plastics (7 ~ 55mm). Plunge cutting.

Pack Quantity	I mm	L mm	TS Tooth spacing mm	ORDER NO. T shank						
5	75	100	4	JT101D-5						

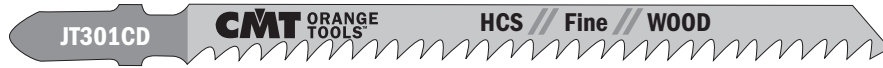

JT301CD

Straight cuts, fine finishing, on hard/soft woods, plywood, laminates, plastics (7 ~ 65mm).

Pack Quantity	I mm	L mm	TS Tooth spacing mm	ORDER NO. T shank						
5	90	116	3	JT301CD-5						



JT234X

Extra-clean splinter-free straight cuts on hard/soft woods, plywood, OSB, laminates (3 ~ 65mm).

Pack Quantity	I mm	L mm	TS Tooth spacing mm	ORDER NO. T shank							
5	90	116	2-3	JT234X-5							



JT101BIF

Splinter-free cuts. Special for all laminates, HPL and multiplex panels (1,5 ~ 15mm).

Pack Quantity	I mm	L mm	TS Tooth spacing mm	ORDER NO. T shank			
5	58	83	1,7	JT101BIF-5			

Saw blades
Jig saw blades
Tools with bore & Knives
Router bits & sets
CNC router cutter & chucks
Industrial dowel drills
Bits for hand power tools
Power tools & accessories
Display cabinets & spare parts

Jig saw blades for wood



JT118A

Straight cuts on thin sheet metals, ferrous and non-ferrous (1 ~ 3mm).

Pack Quantity	l mm	L mm	TS Tooth spacing mm	ORDER NO. T shank
5	50	76	1,2	JT118A-5



JT218A

Curve cuts on thin sheet metals, ferrous and non-ferrous (1 ~ 3mm).

Pack Quantity	l mm	L mm	TS Tooth spacing mm	ORDER NO. T shank
5	50	76	1,2	JT218A-5



JT118B

Straight cuts on medium-thick metals, ferrous and non-ferrous (2,5 ~ 6mm).

Pack Quantity	l mm	L mm	TS Tooth spacing mm	ORDER NO. T shank
5	50	76	2	JT118B-5



JT123X

Straight cuts on thin to thick sheet metals (1,5 ~ 10mm), pipes, profiles in plastic and aluminium (diameter <30mm), stainless steel (1,5 ~ 3mm).

Pack Quantity	l mm	L mm	TS Tooth spacing mm	ORDER NO. T shank	1,5 ~ 10mm	<30mm	<30mm	<30mm	1,5 ~ 3mm
5	75	100	1,2-2,6	JT123X-5	Thin & Thick	Sheet Metal	Aluminium	PVC Plastic	Pipes, profiles, Stainless Steel



JT127D

Special for aluminium, thin to thick (3 ~ 15mm), pipes + profiles, (diameter <30mm) as well as plastic and fiberglass.

Pack Quantity	l mm	L mm	TS Tooth spacing mm	ORDER NO. T shank	3 ~ 15mm	<30mm	<30mm	<30mm	3 ~ 15mm
5	75	100	3	JT127D-5	Fine Straight	Sheet Metal	Aluminium	PVC Plastic	Pipes, profiles, Fiberglass

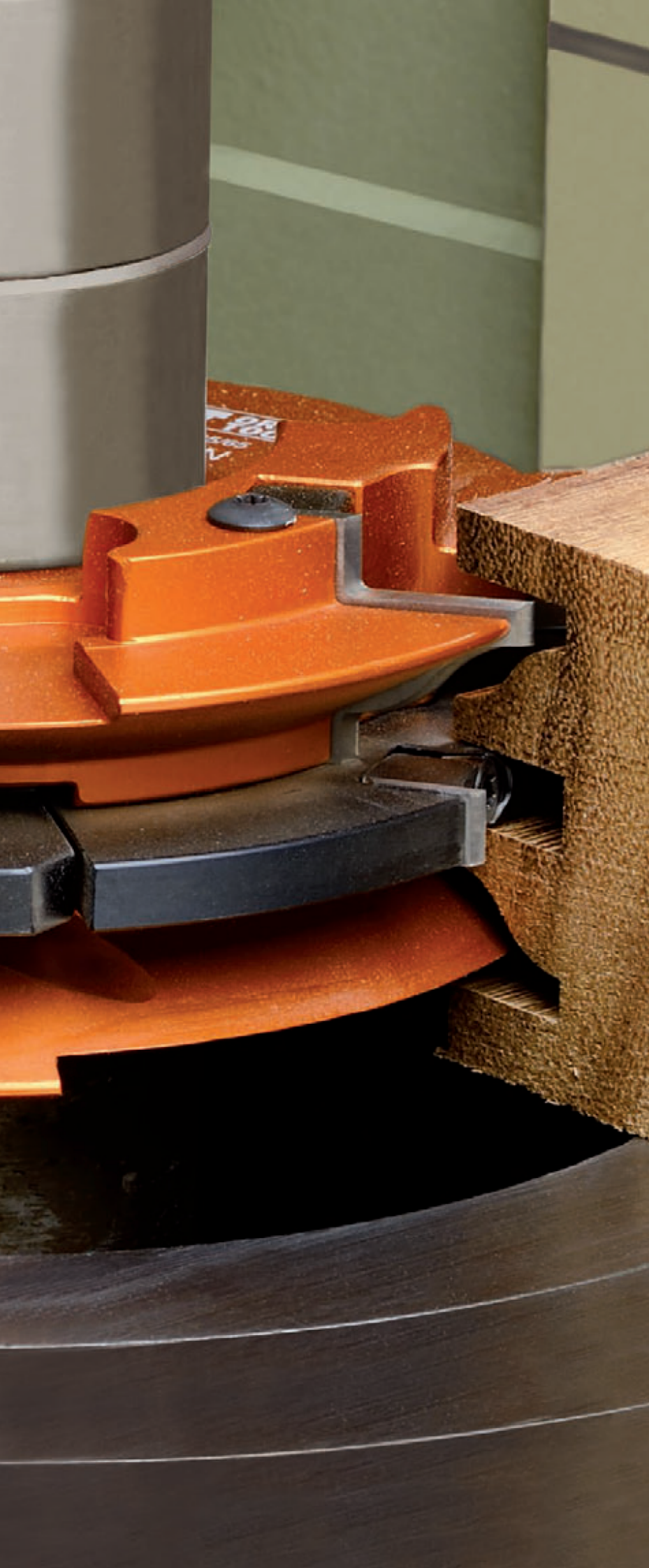

Tools with bore & knives

PRODUCTS	PAGE
Rabbeting cutter heads	52 - 53
3 piece adjustable grooving set	54 - 55
Planing and jointing spiral cutter heads	56
2 piece adjustable rounding & chamfering set	57
Chamfer cutter heads	58 - 59
Multiradius roundover cutter heads	60 ~ 62
Jointing cutter heads	63 ~ 65
Panel cutter heads	66 ~ 69
Cutter heads for universal knives & sets	70 ~ 72
Profile knives and limiters	73 ~ 86
Blank knives and limiters (to be sharpened)	87
Bore reducers	87
HS corrugated back moulder knives	88
Magnetic knife setting jigs	88
Planer and jointer knives	89 - 90
HWM reversible knives for portable planers	91
HWM reversible knives	92 - 93

Rabbeting cutter heads



694.100

These cutter heads have been designed for:

- rabbeting from top and from bottom
- jointing
- grooving

on your spindle moulder machines, double-end tenoner and edging machines.

Perfect on all materials, but better results are achieved using chipboard, MDF, wood composites, plastic materials and laminates. Improved design with shear angle.

TECHNICAL DETAILS:

- Hard aluminium alloy body with high resistance to tensile and yield stress
- 2 universal HWM straight knives 50x12x1,5mm [Z2]
- 4 universal HWM scoring knives 14x14x2mm [V4]
- Tools for manual feed MAN
- Pins for the automatic positioning of the knives

Supplied in a solid plastic box.

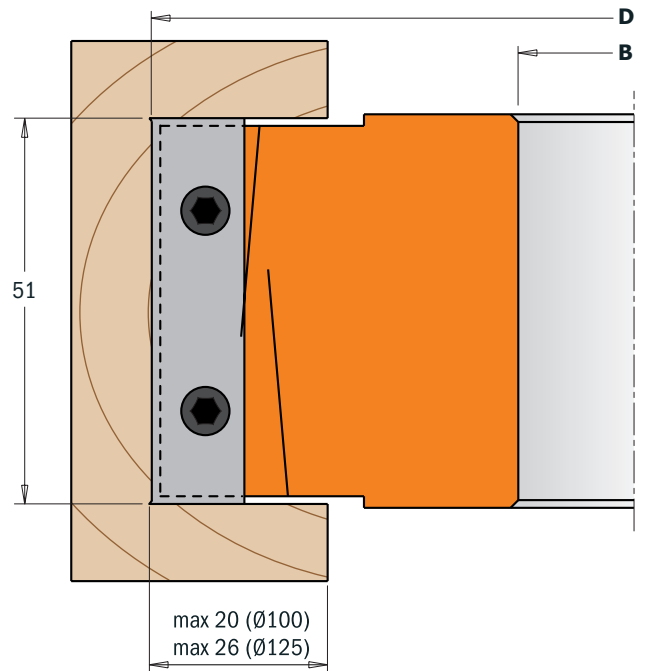
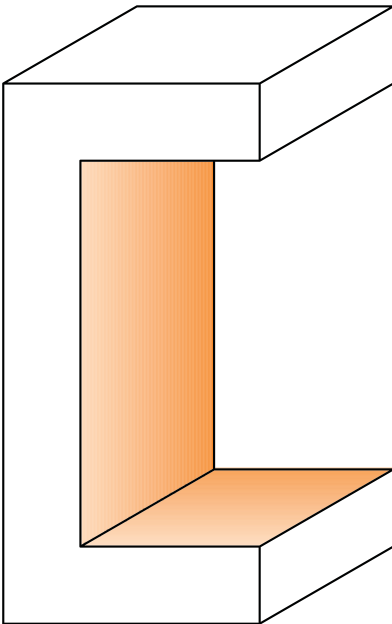
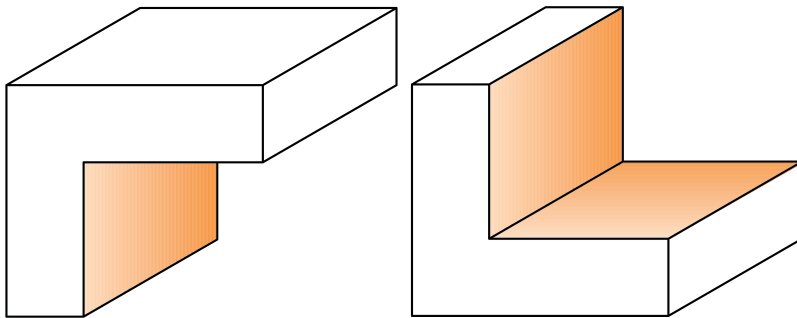

Drawings are 1:1 scale

Spare parts

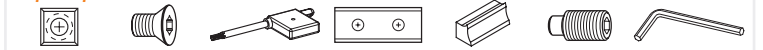

D mm	B mm	I mm	Z	RPM	ORDER NO.							
100	19,05	51	2+4	7500~12500	694.100.19	790.140.00	990.093.00	991.073.00	790.500.00	695.999.46	990.064.00	991.064.00
100	30	51	2+4	7500~12500	694.100.30	790.140.00	990.093.00	991.073.00	790.500.00	695.999.46	990.064.00	991.064.00
100	31,75	51	2+4	7500~12500	694.100.31	790.140.00	990.093.00	991.073.00	790.500.00	695.999.46	990.064.00	991.064.00
100	35	51	2+4	7500~12500	694.100.35	790.140.00	990.093.00	991.073.00	790.500.00	695.999.46	990.064.00	991.064.00
125	40	51	2+4	6100~10000	694.125.40	790.140.00	990.093.00	991.073.00	790.500.00	695.999.46	990.064.00	991.064.00
125	50	51	2+4	6100~10000	694.125.50	790.140.00	990.093.00	991.073.00	790.500.00	695.999.46	990.064.00	991.064.00



694.020

These cutter heads have been designed for:

- rabbeting from top and from bottom
- jointing
- grooving
- 40mm SP profile knives

on your spindle moulder machines, double-end tenoners and edging machines.

Perfect on all materials, but better results are achieved on chipboard, MDF, wood composites, plastic materials and laminates.

TECHNICAL DETAILS:

- Hard aluminium alloy body with high resistance to tensile and yield stress
- 2 universal HWM straight knives 40x12x1,5mm [Z2]
- 2 universal HWM scoring knives 14x14x2mm [V2]
- Tools for manual feed MAN
- Pins for the automatic positioning of the knives

Supplied in a solid plastic box.

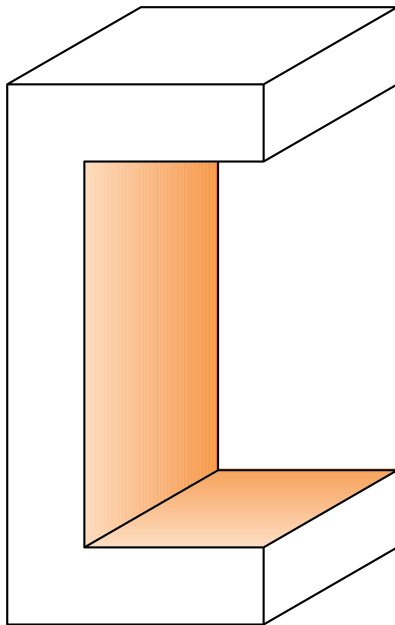

Drawing is 1:1 scale

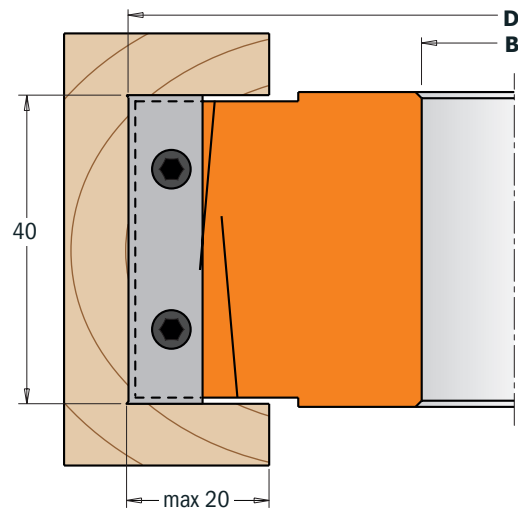

To use with all 40mm profile knives
(see from page 73 to page 82)

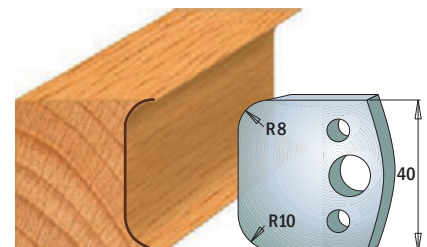
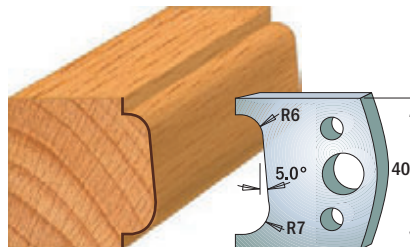
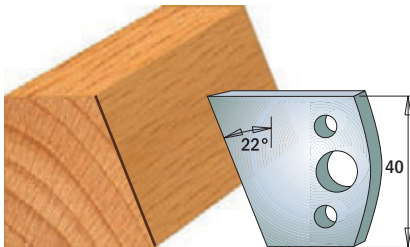

Spare parts

D mm	B mm	I mm	Z	RPM	ORDER NO.							
98	30	40	2+2	7500~12500	694.020.30	790.140.00	990.093.00	991.073.00	790.400.00	693.999.01	990.065.00	991.064.00
98	31,75	40	2+2	7500~12500	694.020.31	790.140.00	990.093.00	991.073.00	790.400.00	693.999.01	990.065.00	991.064.00
98	35	40	2+2	7500~12500	694.020.35	790.140.00	990.093.00	991.073.00	790.400.00	693.999.01	990.065.00	991.064.00
118	40	40	2+2	7500~12500	694.020.40	790.140.00	990.093.00	991.073.00	790.400.00	693.999.01	990.065.00	991.064.00
118	50	40	2+2	7500~12500	694.020.50	790.140.00	990.093.00	991.073.00	790.400.00	693.999.01	990.065.00	991.064.00

Spare parts

691.190 Pair of limiters 38x4x16mm

3 piece adjustable grooving sets



694.001

These cutter heads are the ideal tools to create precision slots and grooves on material from 4 to 15mm deep. These sets include:
 - 2 cutter heads type (A) Z4 + V4
 - 1 cutter head type (B) Z2
 - 12 spacer rings from 0,1 to 2mm

For use on your spindle moulder machines, double-end tenoner and shaper machines. Perfect grooving on all materials, but ideal on solid wood, plywood and laminated panels.

TECHNICAL DETAILS:

- Super-strength steel body
- 2 HWM Knives 7,65x12x1,5mm [Z2]
- 4 HWM Knives 18x18x1,5mm [Z4]
- 4 HWM Knives 14x14x1,2mm [V4]
- Tools for manual feed MAN
- Pins for the automatic positioning of the knives

Supplied in a solid plastic box.

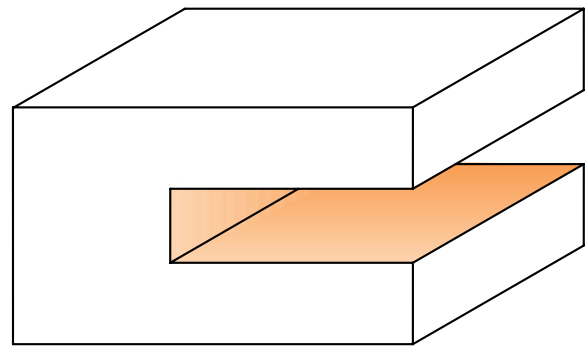
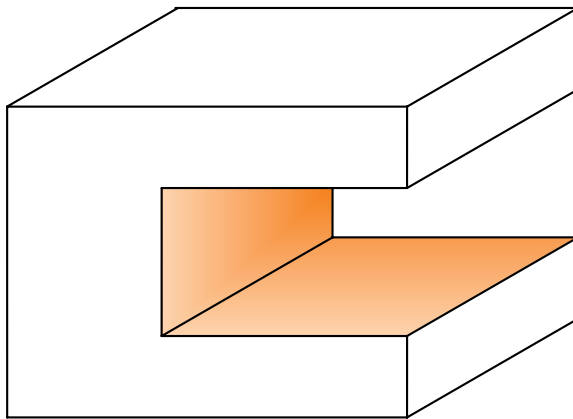
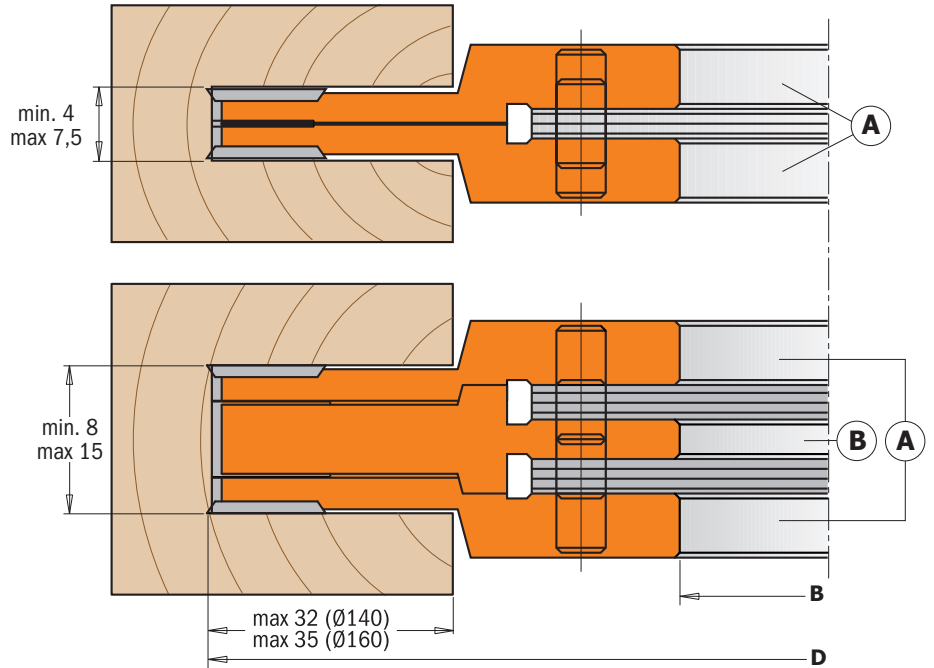

Drawings are 1:1 scale

D mm	B mm	Z + V	RPM	ORDER NO.
140	30	4+4	5500~9500	694.001.30
140	31,75	4+4	5500~9500	694.001.31
140	35	4+4	5500~9500	694.001.35
160	40	4+4	4800~8300	694.001.40
160	50	4+4	4800~8300	694.001.50

Spare parts

790.181.00	790.140.10	790.076.00	695.998.21
790.181.00	790.140.10	790.076.00	695.998.22
790.181.00	790.140.10	790.076.00	695.998.23
790.181.00	790.140.10	790.076.00	695.998.24N
790.181.00	790.140.10	790.076.00	695.998.25N

Spare parts

For cutter heads (A)

- 990.079.00** M4x3,2mm Torx screws
- 991.069.00** T9 Torx key
- 695.996.02** M4 (Ø12x1,7mm) threaded ring
- 695.996.01** M4 (Ø10x1,6mm) threaded ring

For cutter heads (B)

- 695.999.07** 7x11x9,5mm wedge for knives
- 990.063.00** M5x18mm screw
- 991.072.00** T20 Torx key



694.021 - 694.022



These cutter heads are the ideal tools to create precision slots and grooves on material from 14 to 39mm deep. These sets include:

- 1 cutter head type (A) Z2 + V2
- 1 cutter head type (B) Z2 + V2
- spacer rings set

For use on your spindle moulder machines, double-end tenoners and shaper machines. Perfect grooving on all materials, but ideal on solid wood, plywood and laminated panels.

TECHNICAL DETAILS:

- Super-strength hard aluminium alloy body
- 694.021: 8 HWM Knives 13,6x13,6x2mm
- 694.022: 8 HWM Knives 19,5x12x1,5mm
- 4 HWM Scoring knives 14x14x2mm
- Tools for manual feed MAN
- Pins for the automatic positioning of the knives

Supplied in a solid plastic box.

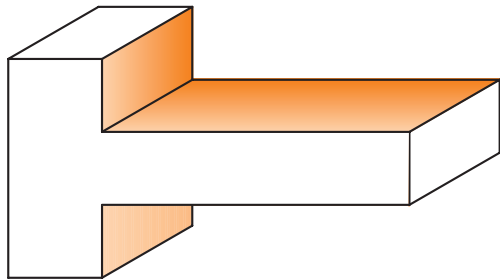
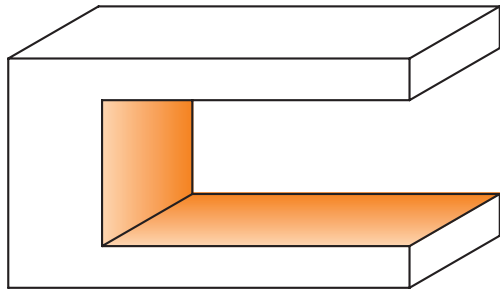

Drawings are 1:1 scale

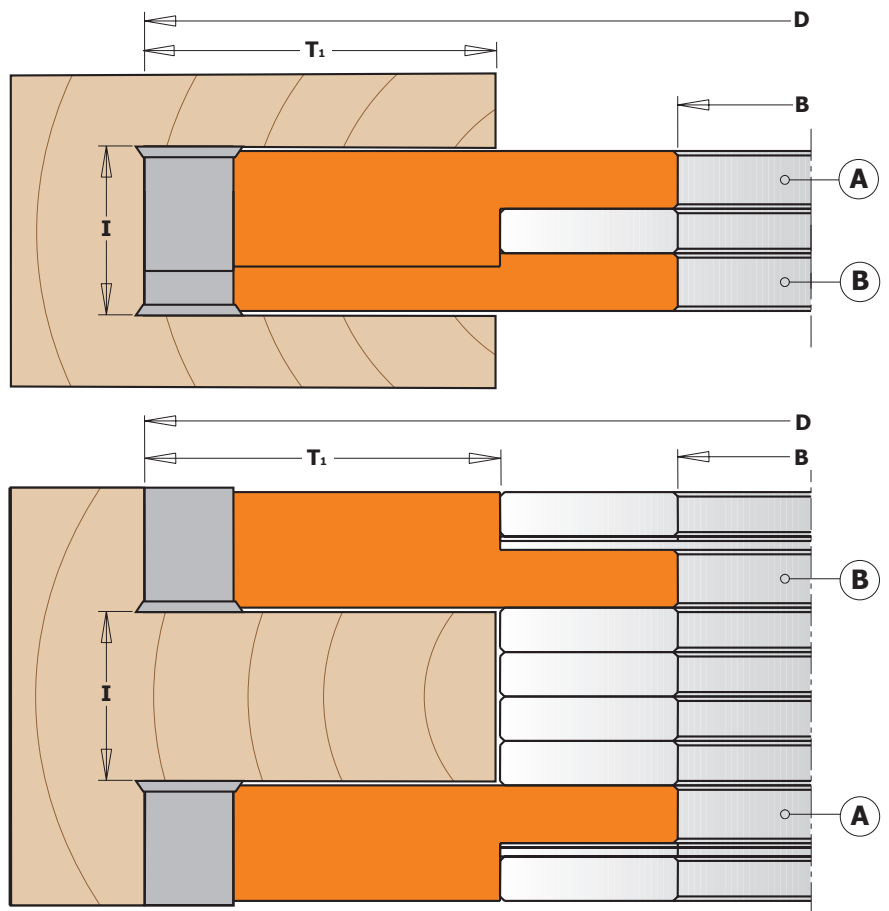

D mm	I mm	B mm	T ₁ mm	Z	RPM	ORDER NO.	Spare parts									
150	14-28	30	59	4+4	5000~8000	694.021.30						790.136.00	990.093.00	695.998.41		
150	14-28	31,75	44	4+4	5000~8000	694.021.31	790.136.00	990.093.00				790.136.00	990.093.00	695.998.42		
150	14-28	35	44	4+4	5000~8000	694.021.35	790.136.00	990.093.00				790.136.00	990.093.00	695.998.43		
150	14-28	40	44	4+4	5000~8000	694.021.40	790.136.00	990.093.00				790.136.00	990.093.00	695.998.44		
160	14-28	50	44	4+4	5000~8000	694.021.50	790.136.00	990.093.00				790.136.00	990.093.00	695.998.45		
170	20-39	30	54	4+4	4400~7400	694.022.30	790.140.00	990.093.00	790.195.12	990.094.00		790.140.00	990.093.00	790.195.12	990.094.00	695.998.46
170	20-39	31,75	54	4+4	4400~7400	694.022.31	790.140.00	990.093.00	790.195.12	990.094.00		790.140.00	990.093.00	790.195.12	990.094.00	695.998.47
170	20-39	35	54	4+4	4400~7400	694.022.35	790.140.00	990.093.00	790.195.12	990.094.00		790.140.00	990.093.00	790.195.12	990.094.00	695.998.48
170	20-39	40	54	4+4	4400~7400	694.022.40	790.140.00	990.093.00	790.195.12	990.094.00		790.140.00	990.093.00	790.195.12	990.094.00	695.998.49
170	20-39	50	59	4+4	4400~7400	694.022.50	790.140.00	990.093.00	790.195.12	990.094.00		790.140.00	990.093.00	790.195.12	990.094.00	695.998.50

Spare parts
991.072.00 T20 Torx key
991.073.00 T25 Torx key

Planing and jointing spiral cutter heads

INSERT CARBIDE MAN Z12



694.019

These new cutter heads have been designed for planing and jointing on soft or hard wood and wooden boards on spindle moulder machines. Ideal for routing our curved elements by using a bearing guide (sold separately) and a template.

TECHNICAL DETAILS:

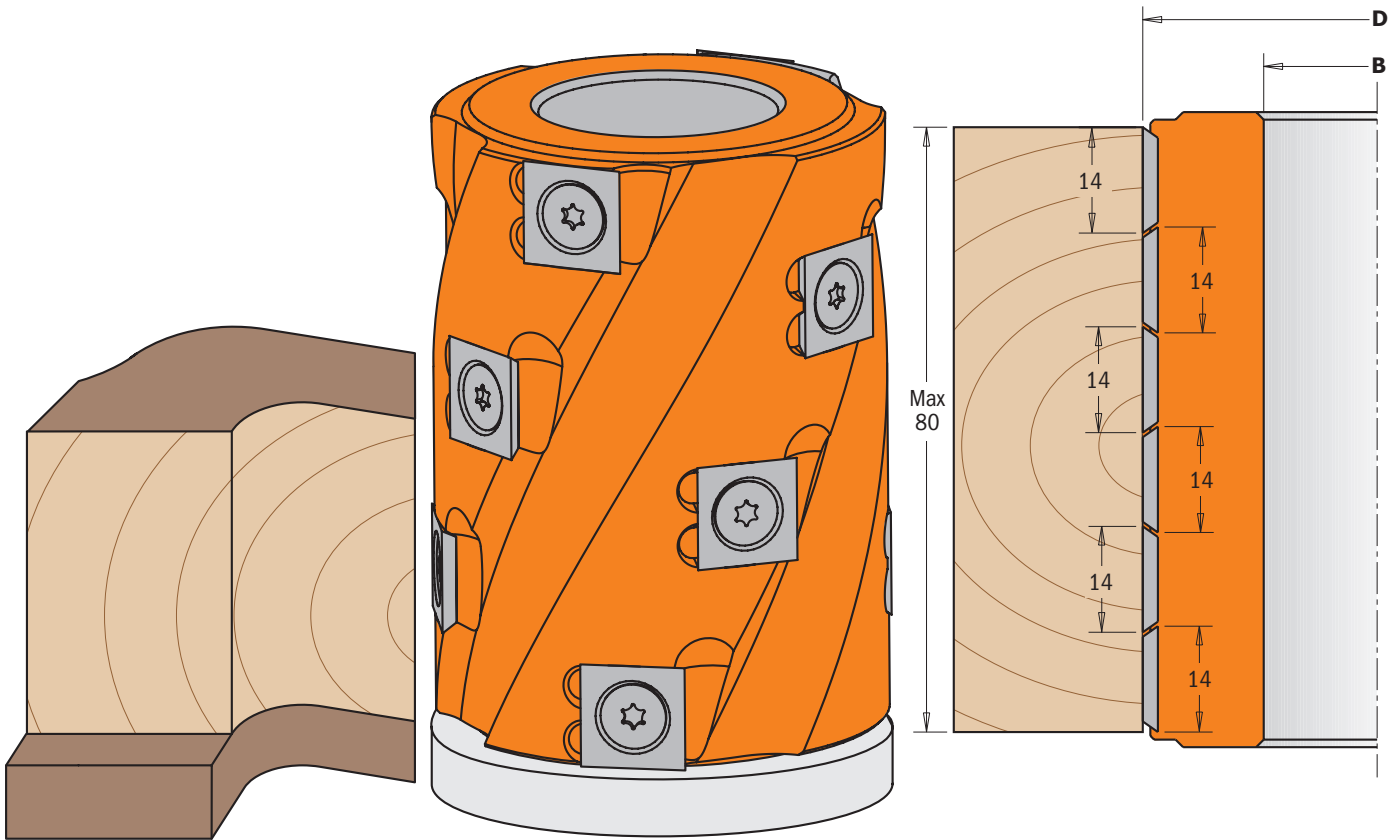

- Hard aluminium alloy body with high resistance to tensile and yield stress
- 12 HWM Knives 14x14x2mm (Z2) with 4 spiral indexing
- Tools for manual feed MAN

Supplied in a plastic twistpack.



Optional bearing

Spare parts

D mm	I mm	B mm	Z	RPM	ORDER NO.			
62	80	30	12	8000~12000	694.019.30	790.140.00	990.093.00	991.073.00
62	80	35	12	8000~12000	694.019.35	790.140.00	990.093.00	991.073.00
80	80	40	12	8000~12000	694.019.40	790.140.00	990.093.00	991.073.00
80	80	50	12	8000~12000	694.019.50	790.140.00	990.093.00	991.073.00

- Optional**
- 791.051.00** 30x62x16mm bearing
 - 791.052.00** 35x62x14mm bearing
 - 791.054.00** 40x80x18mm bearing
 - 791.053.00** 50x80x16mm bearing

Note: Ideal for routing out curved elements by using an bearing guide (sold separately) and a template. In order to achieve an extra-fine finishing, you can order the optional knife 790.140.20.

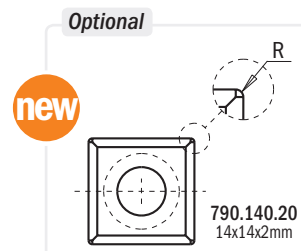

790.140.20
14x14x2mm

Saw blades

Jig saw blades

Tools with bore & Knives

Router bits & sets

CNC router cutter & chucks

Industrial dowel drills

Bits for hand power tools

Power tools & accessories

Display cabinets & spare parts

2 piece adjustable rounding & chamfering sets



694.005



Innovative design, simple assembly and numerous possibilities. The CMT adjustable rounding and chamfering sets consist of two pieces, which are very easy to set up on your spindle moulder machine, allowing you to profile on solid wood and man-made boards (with or without coating). It supports five different knives for rounding over both top and bottom edges in one single pass with radius 2,3,4,5 or 6mm, and for 45° chamfering on material from 18mm to 50mm thick. The improved design with shear angle guarantees perfect finishing! For use on spindle moulder machines and double-end tenoners.

TECHNICAL DETAILS:

- Hard aluminium alloy body with high resistance to tensile and yield stress
- One pair of HWM top knives radius 4mm and 45° chamfer (20x20,5x2mm) [Z2]
- One pair of HWM bottom knives radius 4mm and 45° chamfer (20x20,5x2mm) [Z2]
- Two HWM knives 50x12x1,5mm
- Set of 21 spacer rings from 0,1 to 3mm
- Tools for manual feed MAN
- Pins for the automatic positioning of the knives

Supplied in a solid plastic box.

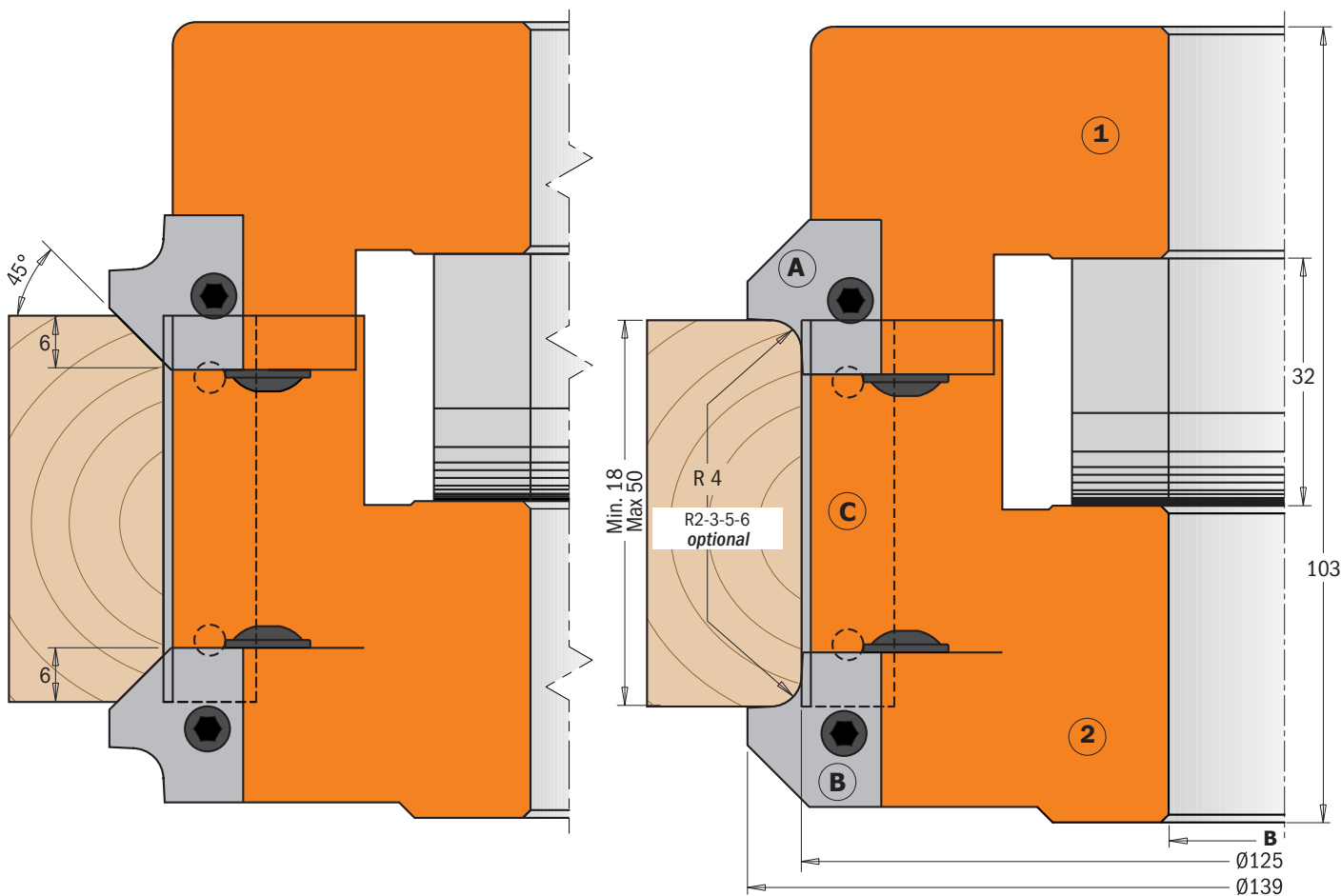

D mm	B mm	Z	RPM	ORDER NO.
139	30	2+2	5500~9400	694.005.30
139	31,75	2+2	5500~9400	694.005.31
139	35	2+2	5500~9400	694.005.35
139	40	2+2	5500~9400	694.005.40
139	50	2+2	5500~9400	694.005.50

Spare parts

17x11x9,5mm	46x11x9,5mm	990.064.00	695.998.11
695.999.17	695.999.46	990.064.00	695.998.11
695.999.17	695.999.46	990.064.00	695.998.12
695.999.17	695.999.46	990.064.00	695.998.13
695.999.17	695.999.46	990.064.00	695.998.14
695.999.17	695.999.46	990.064.00	695.998.15

Spare parts

695.005.A4	R=4+45° pair of knives for roundover/chamfer (top)
695.005.B4	R=4+45° pair of knives for roundover/chamfer (bottom)
790.500.00	50x12x1,5mm knives
991.064.00	4mm hex key
991.067.00	3mm hex key

Optional

695.005.A2	R=2+45° pair of knives for roundover/chamfer (top)
695.005.A3	R=3+45° pair of knives for roundover/chamfer (top)
695.005.A5	R=5+45° pair of knives for roundover/chamfer (top)
695.005.A6	R=6+45° pair of knives for roundover/chamfer (top)
695.005.B2	R=2+45° pair of knives for roundover/chamfer (bottom)
695.005.B3	R=3+45° pair of knives for roundover/chamfer (bottom)
695.005.B5	R=5+45° pair of knives for roundover/chamfer (bottom)
695.005.B6	R=6+45° pair of knives for roundover/chamfer (bottom)

45° chamfer cutter heads

Saw blades

Jig saw blades

Tools with bore & Knives

Router bits & sets

CNC router cutter & chucks

Industrial dowel drills

Bits for hand power tools

Power tools & accessories

Display cabinets & spare parts



694.002

CMT chamfer cutter heads carry out clean accurate bevels and joints for excellent edge work. For use on spindle moulder machines, double-end tenoner and shaper machines. Perfect on all materials, but ideal on solid wood, veneered, panel and plastic-coated materials.



TECHNICAL DETAILS:

- Hard aluminium alloy body with high resistance to tensile and yield stress
- 2 HWM Knives 50x12x1,5mm [Z2]
- Tools for manual feed MAN
- Pins for the automatic positioning of the knives

Supplied in a solid plastic box.

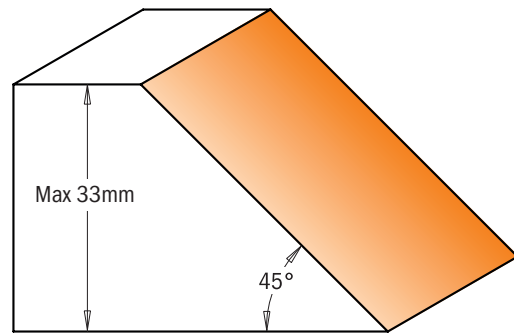
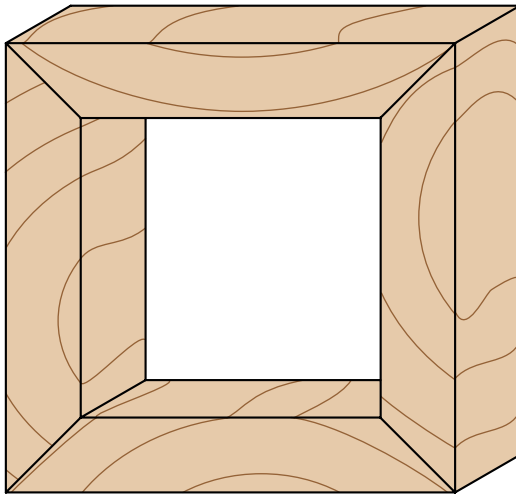
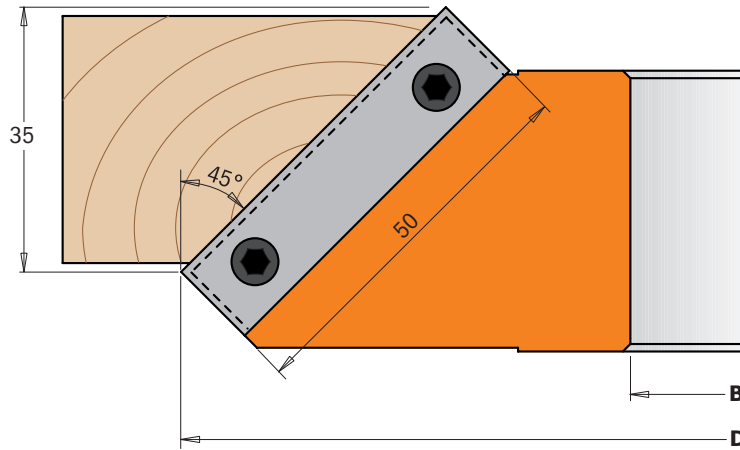

Drawing is 1:1 scale

D mm	B mm	Z	RPM	ORDER NO.	Spare parts			
150	30	2	5100~8800	694.002.30				
150	31,75	2	5100~8800	694.002.31	790.500.00	695.999.42	990.064.00	991.064.00
150	35	2	5100~8800	694.002.35	790.500.00	695.999.42	990.064.00	991.064.00
150	40	2	5100~8800	694.002.40	790.500.00	695.999.42	990.064.00	991.064.00
160	50	2	4800~8300	694.002.50	790.500.00	695.999.42	990.064.00	991.064.00

Adjustable chamfer cutter heads with positive stop



694.018



These new adjustable chamfer cutter heads carry out precise cuts, accurate bevels and joints on wooden boards and solid timber. For use on your spindle moulder machines, double-end tenoner and shaper machines.

TECHNICAL DETAILS:

- Hard aluminium alloy body with high resistance to tensile and yield stress
- 2 HWM Knives 40x12x1,5mm (Z2)
- Tools for manual feed MAN
- Positive lock hold of HWM knives, swivel bodies infinitely adjustable on both sides from 0 to 45°, with positive stop every 7,5° step, thanks to the special built-in geared mechanism.

Supplied in a solid plastic box.

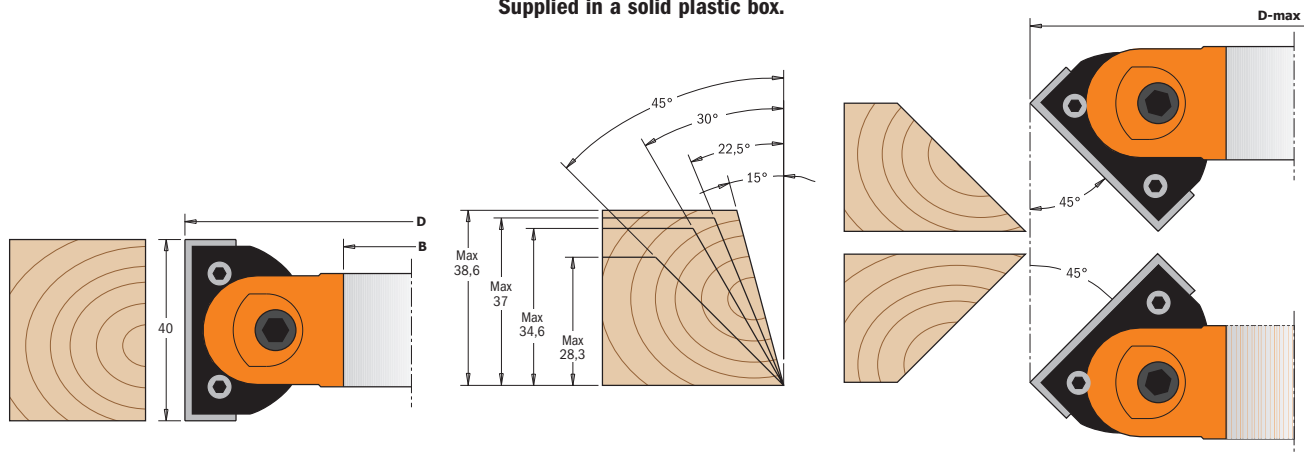

D mm	I mm	B mm	Z	D_Max 45° mm	RPM	ORDER NO.
120	40	30	2	140	7000~9000	694.018.30
120	40	35	2	140	7000~9000	694.018.35
145	40	40	2	165	4800~7200	694.018.40
145	40	50	2	165	4800~7200	694.018.50

Spare parts

Part	Part	Part	Part
695.018.01	790.400.00	990.094.00	991.072.00
695.018.01	790.400.00	990.094.00	991.072.00
695.018.01	790.400.00	990.094.00	991.072.00
695.018.01	790.400.00	990.094.00	991.072.00

Spare parts **991.065.00** 5mm hex key

Professional adjustable chamfer cutter heads with gear box

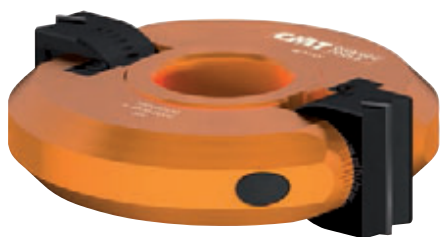

694.017



These new professional adjustable chamfer cutter heads carry out precise cuts, accurate bevels and joints on wooden boards and solid timber. For use on your spindle moulder machines, double-end tenoner and shaper machines.

TECHNICAL DETAILS:

- Hard aluminium alloy body with high resistance to tensile and yield stress.
- 2 HWM knives (50x14x1,5mm - Z2).
- Tools for manual feed (MAN).
- Positive lock hold of HWM knives.
- Swivel bodies infinitely adjustable on both sides from 0° to 45°, thanks to the special built-in geared mechanism.

Supplied in a solid plastic box.

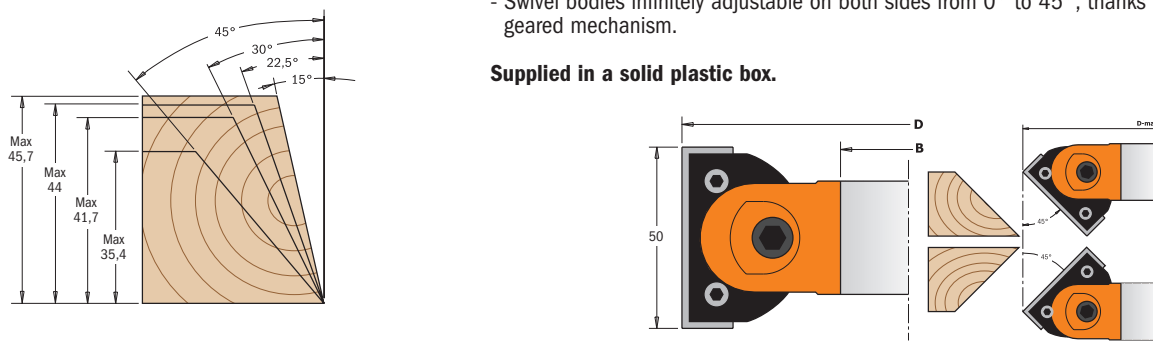

D mm	I mm	B mm	Z	D_Max 45° mm	RPM	ORDER NO.
160	50	30	2	183	4800~6000	694.017.30
160	50	35	2	183	4800~6000	694.017.35
160	50	50	2	183	4800~6000	694.017.50

Spare parts

Part	Part	Part	Part	Part
695.017.01	790.500.00	695.999.48	990.106.00	991.067.00
695.017.01	790.500.00	695.999.48	990.106.00	991.067.00
695.017.01	790.500.00	695.999.48	990.106.00	991.067.00

Spare parts **991.081.00** 4mm hex key

Multiradius roundover cutter heads



694.003

Innovative cutter heads supporting three different knives for making six radius roundover profiles. Standard cutter heads are sold with knives featuring radii 5 and 10mm; two more knife sets are available for radii 4-8mm and 3-6mm. For use on spindle moulder machines, double-end tenoner and shaper machines. Perfect on all materials, but ideal on solid wood and panel materials.

TECHNICAL DETAILS:

- Hard aluminium alloy body with high resistance to tensile and yield stress
- 2 HWM knives radius 5/10mm (25x24,8x2mm) [Z2]
- Tools for manual feed MAN
- Pins for the automatic positioning of the knives

Supplied in a solid plastic box.

Standard

Pair of knives **695.003.05**

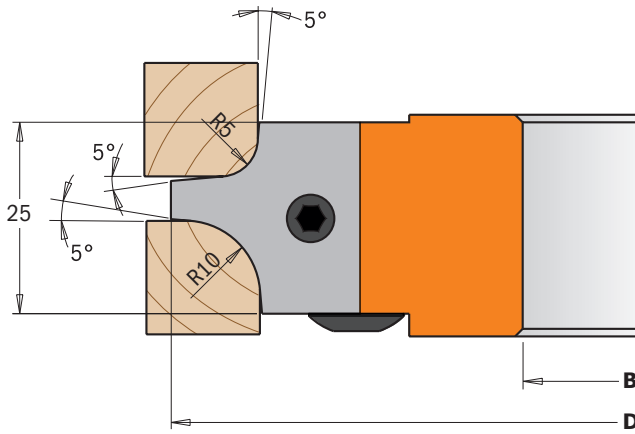

Optional

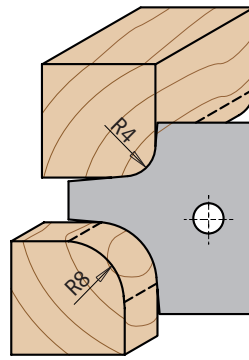

Pair of knives **695.003.04**

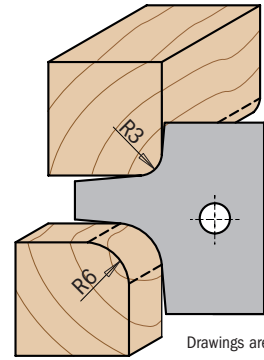

Pair of knives **695.003.03**

Drawings are 1:1 scale

D mm	B mm	Z	RPM	ORDER NO.	Spare parts x2			
113	30	2	6700~11000	694.003.30	695.003.05	695.999.22	990.064.00	991.064.00
113	31,75	2	6700~11000	694.003.31	695.003.05	695.999.22	990.064.00	991.064.00
113	35	2	6700~11000	694.003.35	695.003.05	695.999.22	990.064.00	991.064.00
128	40	2	5900~9700	694.003.40	695.003.05	695.999.22	990.064.00	991.064.00
128	50	2	5900~9700	694.003.50	695.003.05	695.999.22	990.064.00	991.064.00

Optional
695.003.04 R=4/8mm (25x24,8x2mm) pair of profiled knives
695.003.03 R=3/6mm (25x24,8x2mm) pair of profiled knives



694.004



Innovative cutter heads supporting two different knives for making four radius roundover profiles. Standard cutter heads are sold with knives featuring radii 15 and 20mm; one more knife set is available for radii 12-18mm. For use on spindle moulder machines, double-end tenorer and shaper machines. Perfect on all materials, but ideal on solid wood and panel materials.

TECHNICAL DETAILS:

- Hard aluminium alloy body with high resistance to tensile and yield stress
- 2 HWM knives radius 15/20mm (45x34,5x2mm) [Z2]
- Tools for manual feed MAN
- Pins for the automatic positioning of the knives

Supplied in a solid plastic box.

Standard

Pair of knives **695.004.15**

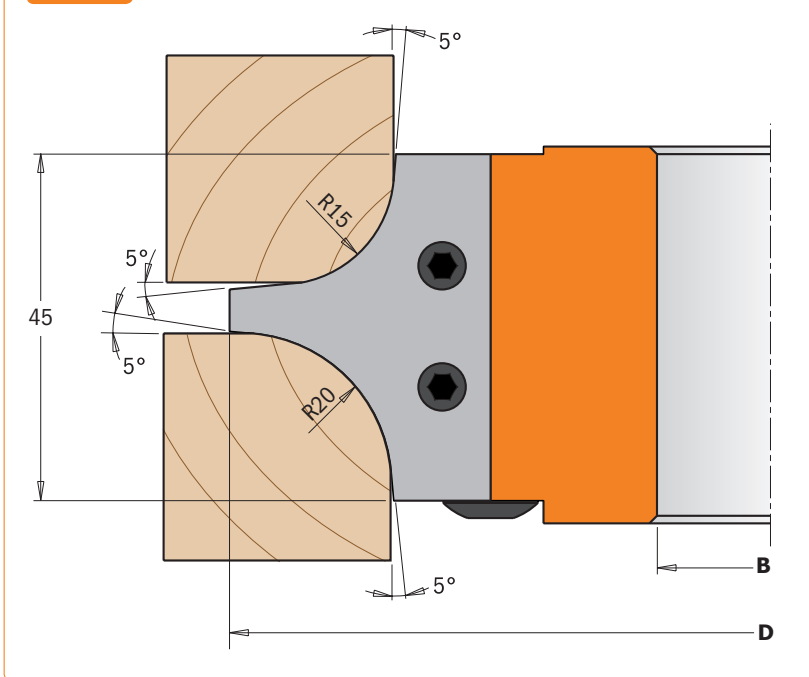

Optional

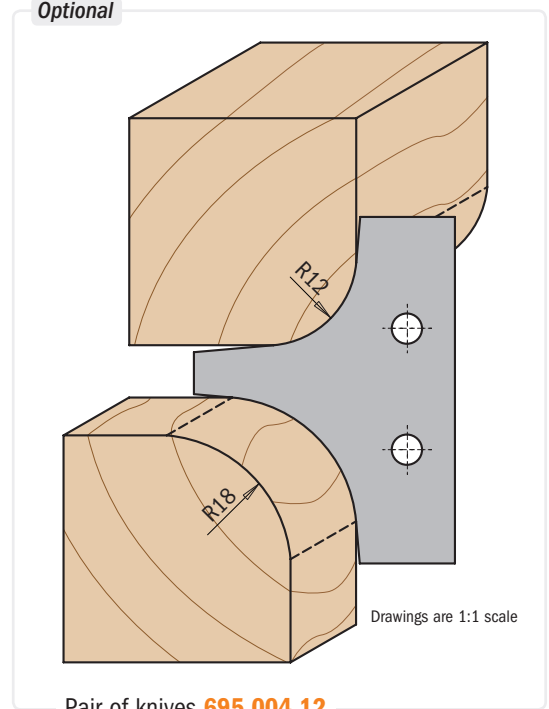

Pair of knives **695.004.12**

D mm	B mm	Z	RPM	ORDER NO.
132	30	2	5700-9500	694.004.30
132	31,75	2	5700-9500	694.004.31
132	35	2	5700-9500	694.004.35
147	40	2	5100-8500	694.004.40
147	50	2	5100-8500	694.004.50

Spare parts



695.004.15	695.999.42	990.064.00	991.064.00
695.004.15	695.999.42	990.064.00	991.064.00
695.004.15	695.999.42	990.064.00	991.064.00
695.004.15	695.999.42	990.064.00	991.064.00
695.004.15	695.999.42	990.064.00	991.064.00

Optional **695.004.12** R=12/18mm (45x34,5x2mm) pair of profiled knives

Roundover and cove cutter heads

Saw blades

Jig saw blades

Tools with bore & Knives

Router bits & sets

CNC router cutter & chucks

Industrial dowel drills

Bits for hand power tools

Power tools & accessories

Display cabinets & spare parts



694.007

These cutter heads are perfect for making furniture, doors and drawer fronts simply and stylishly by giving them a final touch with a CMT cove bit. It is also used for making perfect roundover profiles, drop leaf counters and table tops. You can use three different knives for carrying out roundover and cove profiles with radius 10, 12 and 15mm. For use on spindle moulder machines, double-end tenoner and shaper machines. Perfect on all materials, but ideal on solid wood and panel materials.



TECHNICAL DETAILS:

- Hard aluminium alloy body with high resistance to tensile and yield stress
- 2 HWM knives radius 10mm (34,8x29,3x2mm) [Z2]
- Tools for manual feed MAN
- Pins for the automatic positioning of the knives

Supplied in a solid plastic box.

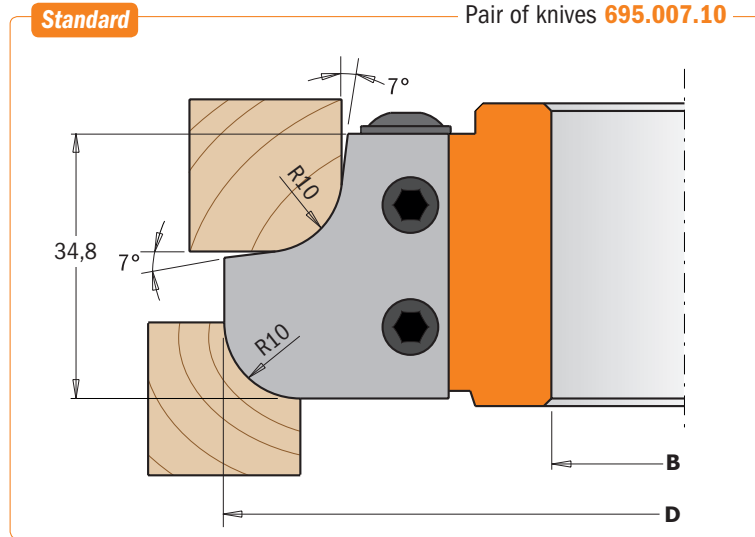

Optional

Pair of knives **695.007.12**

Pair of knives **695.007.15**

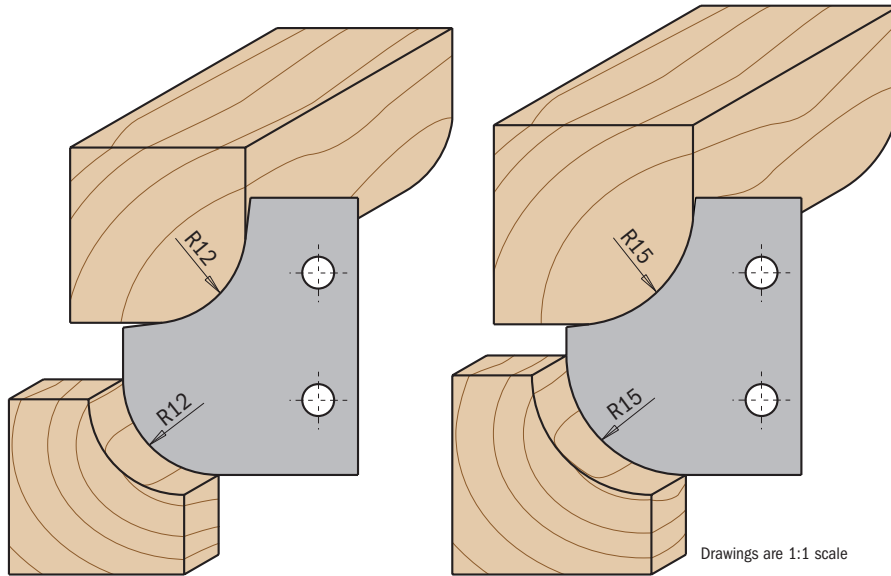

D mm	B mm	Z	RPM	ORDER NO.	Spare parts			
121	30	2	6300~10500	694.007.30	x2			
121	31,75	2	6300~10500	694.007.31	695.007.10	695.999.31	990.064.00	991.064.00
121	35	2	6300~10500	694.007.35	695.007.10	695.999.31	990.064.00	991.064.00
136	40	2	5600~9300	694.007.40	695.007.10	695.999.31	990.064.00	991.064.00
136	50	2	5600~9300	694.007.50	695.007.10	695.999.31	990.064.00	991.064.00

Optional
695.007.12 R=12mm (34,8x29,3x2mm) pair of roundover/cove knives
695.007.15 R=15mm (34,8x29,3x2mm) pair of roundover/cove knives



694.008



The professional CMT finger joint cutter heads allow for making the most incredibly strong side-to-side joints on all wood types and composites. The tightness of the joint and the maximum glue surface make the joint itself stronger than an unworked piece of wood, in stock with maximum 47mm in thickness. Ideal for molding manufactures and furniture makers.

For use on spindle moulder machines, double-end tenoner and shaper machines. Perfect on all materials, but ideal on solid wood and panel materials.

TECHNICAL DETAILS:

- Hard aluminium alloy body with high resistance to tensile and yield stress
- 2 HWM knives 49,6x11,9x1,5mm [Z2]
- Tools for manual feed MAN
- Pins for the automatic positioning of the knives

Supplied in a solid plastic box.

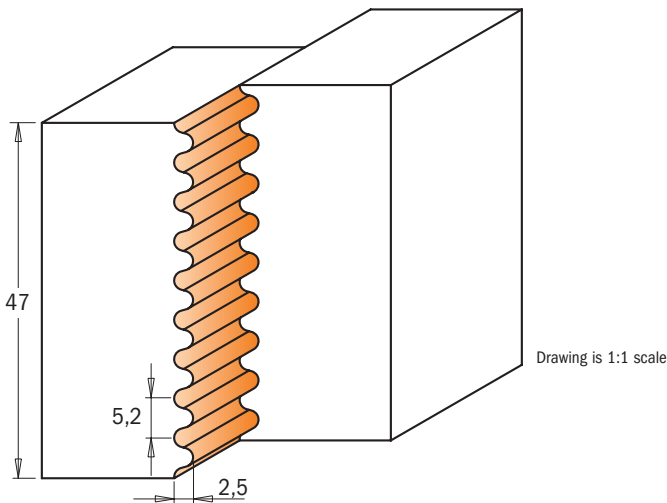
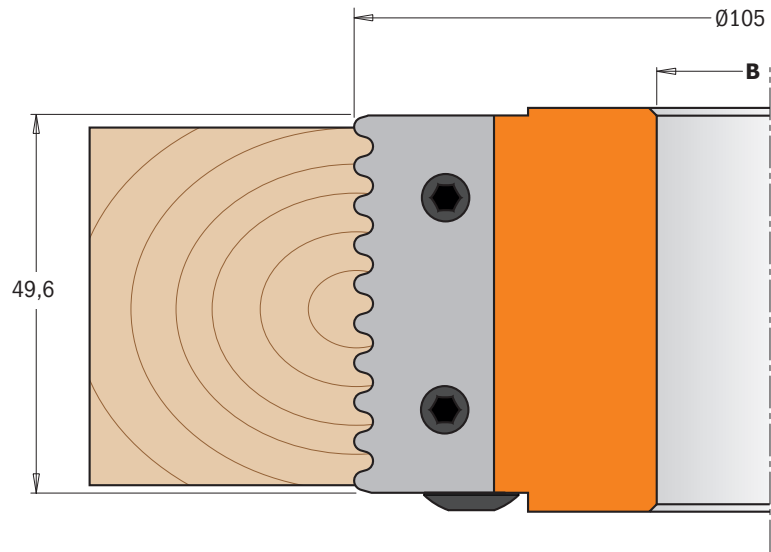

D mm	B mm	Z	RPM	ORDER NO.	Spare parts			
105	30	2	7300~11500	694.008.30	x2			
105	31,75	2	7300~11500	694.008.31	695.008.01	695.999.49	990.066.00	991.067.00
105	35	2	7300~11500	694.008.35	695.008.01	695.999.49	990.066.00	991.067.00
105	40	2	7300~11500	694.008.40	695.008.01	695.999.49	990.066.00	991.067.00
105	50	2	7300~11500	694.008.50	695.008.01	695.999.49	990.066.00	991.067.00

Optional

695.998.2630	Ø50x2,6x30mm guide ring
695.998.2631	Ø50x2,6x31,75mm guide ring
695.998.2635	Ø55x2,6x35mm guide ring
695.998.2640	Ø60x2,6x40mm guide ring
695.998.2650	Ø70x2,6x50mm guide ring

Reverse glue joint cutter heads



694.009

The most unique and important feature of these CMT cutter heads is the capacity to produce almost indestructible glue joints quickly and accurately. Ideal for shaping wide dimension panels, doors and furniture pieces. By accurately centering the cutter head to the wood, the upper and lower vertical cutting edges will cut equal proportions. Simply run one side of the panel, turn the panel over, and then run the opposite side - you will produce perfectly harmonized reverse cuts matching up to make flawless joints. Excellent results on most materials, but ideal on solid wood, coated and uncoated man-made materials.

TECHNICAL DETAILS:

- Hard aluminium alloy body with high resistance to tensile and yield stress
- 2 HWM knives 40x18x2mm [Z2]
- Tools for manual feed MAN
- Pins for the automatic positioning of the knives

Supplied in a solid plastic box.

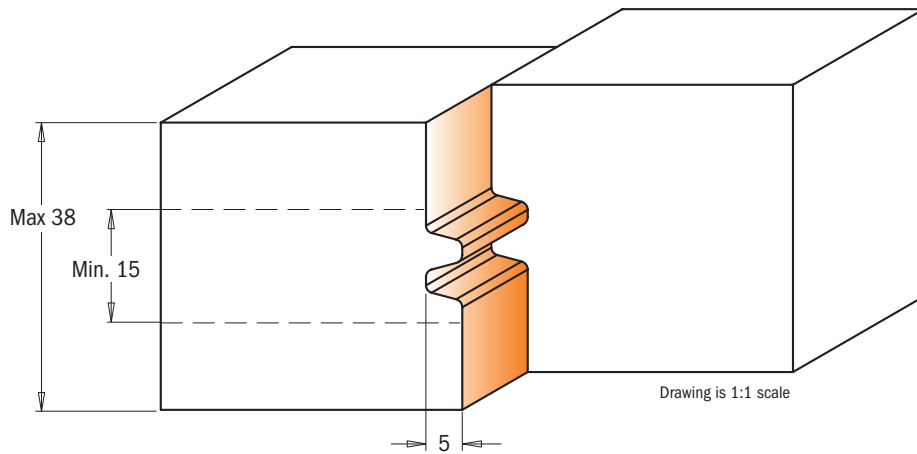
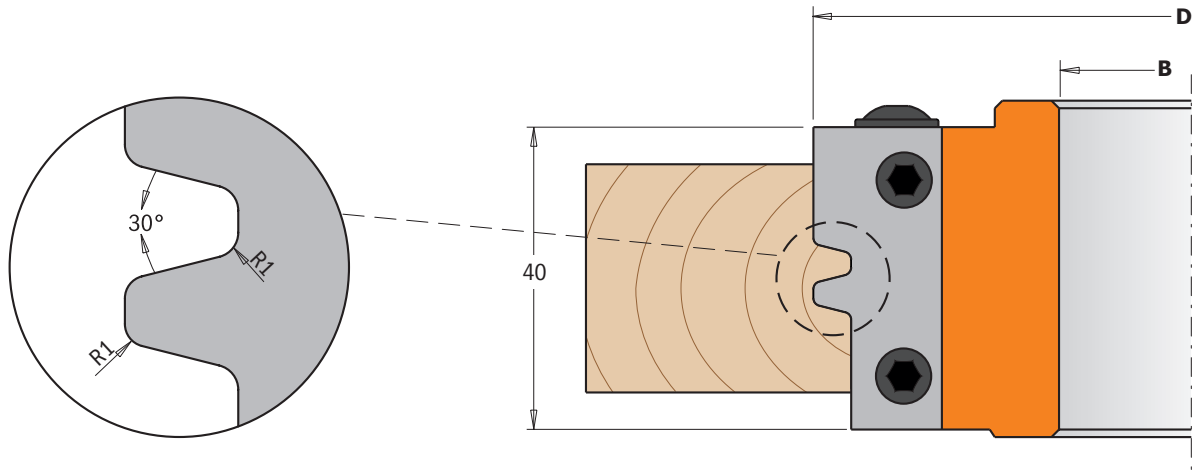

D mm	B mm	Z	RPM	ORDER NO.	Spare parts			
100	30	2	7500~12500	694.009.30	x2			
100	31,75	2	7500~12500	694.009.31	695.009.01	695.999.38	990.064.00	991.064.00
100	35	2	7500~12500	694.009.35	695.009.01	695.999.38	990.064.00	991.064.00
120	40	2	6400~10500	694.009.40	695.009.01	695.999.38	990.064.00	991.064.00
120	50	2	6400~10500	694.009.50	695.009.01	695.999.38	990.064.00	991.064.00



694.011



CMT's lock miter cutter heads are ideal for milling miter joints in stock with maximum 28mm in thickness. Create boxes, stretcher bars, frames and any assortment of right angle or parallel joint projects. Two easy steps to produce perfectly fitting 45° miter joints: first, position your workpiece horizontally, then vertically. Also, create parallel glue joints in two steps: place your workpiece horizontally, internal side facing down, and then turn it facing up. For use on spindle moulder and shaper machines. Perfect on all materials, but ideal on solid wood and panels.

TECHNICAL DETAILS:

- Hard aluminium alloy body with high resistance to tensile and yield stress
- 2 HWM knives 43x23x2mm [Z2]
- Tools for manual feed MAN
- Pins for the automatic positioning of the knives

Supplied in a solid plastic box.

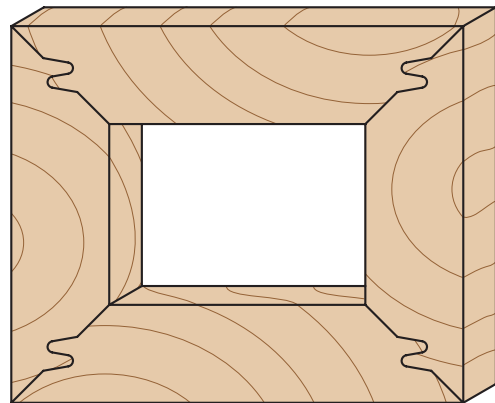
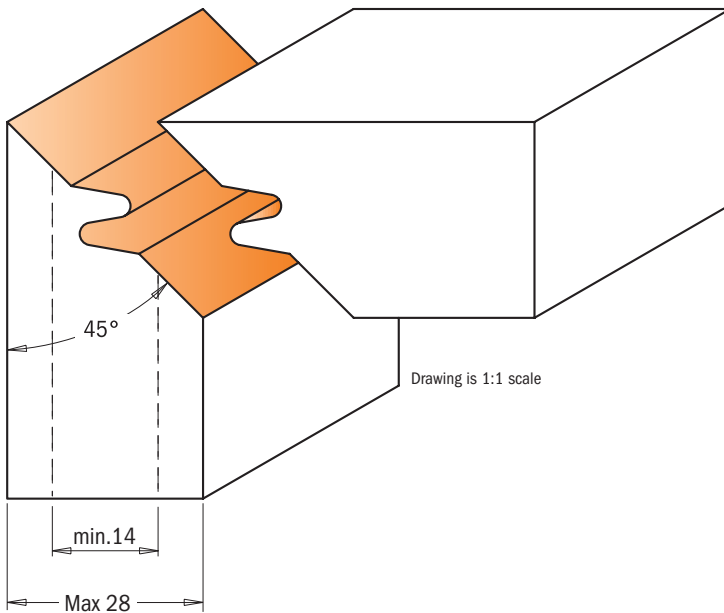
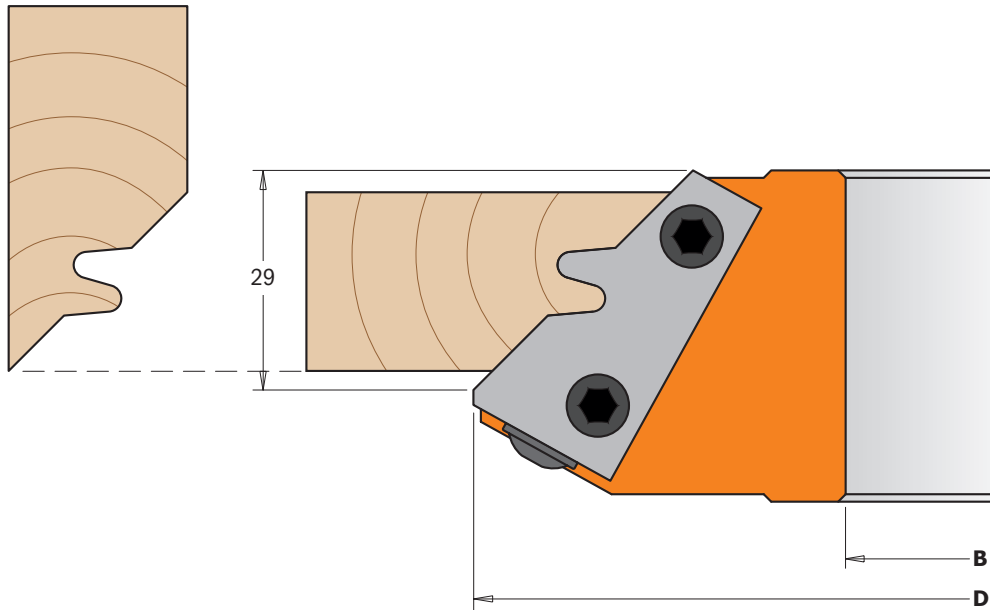

D mm	B mm	Z	RPM	ORDER NO.
140	30	2	5500~9500	694.011.30
140	31,75	2	5500~9500	694.011.31
140	35	2	5500~9500	694.011.35
140	40	2	5500~9500	694.011.40
150	50	2	5100~8800	694.011.50

Spare parts

Icon	Quantity	Part No.	Price
	x2	695.011.01	695.999.42
		990.064.00	991.064.00
		990.064.00	991.064.00
		990.064.00	991.064.00

Professional raised panel cutter heads



694.013



We offer the traditional approach to panel construction with these CMT raised panel cutter heads. Make classic raised panels on furniture, interior and cabinet doors on solid wood and wooden boards, and achieve three different profiles by adjusting the cutting depth. We recommend multiple passes for safe and accurate finishing. For use on spindle moulders. Perfect on all materials, but ideal on solid wood and panels.

TECHNICAL DETAILS:

- Hard aluminium alloy body with high resistance to tensile and yield stress
- 2 HWM Knives type (A) 19,8x11,9x1,5mm [Z2]
- 2 HWM Knives type (B) 60x11,9x1,5mm [Z2]
- Tools for manual feed MAN
- Pins for the automatic positioning of the knives

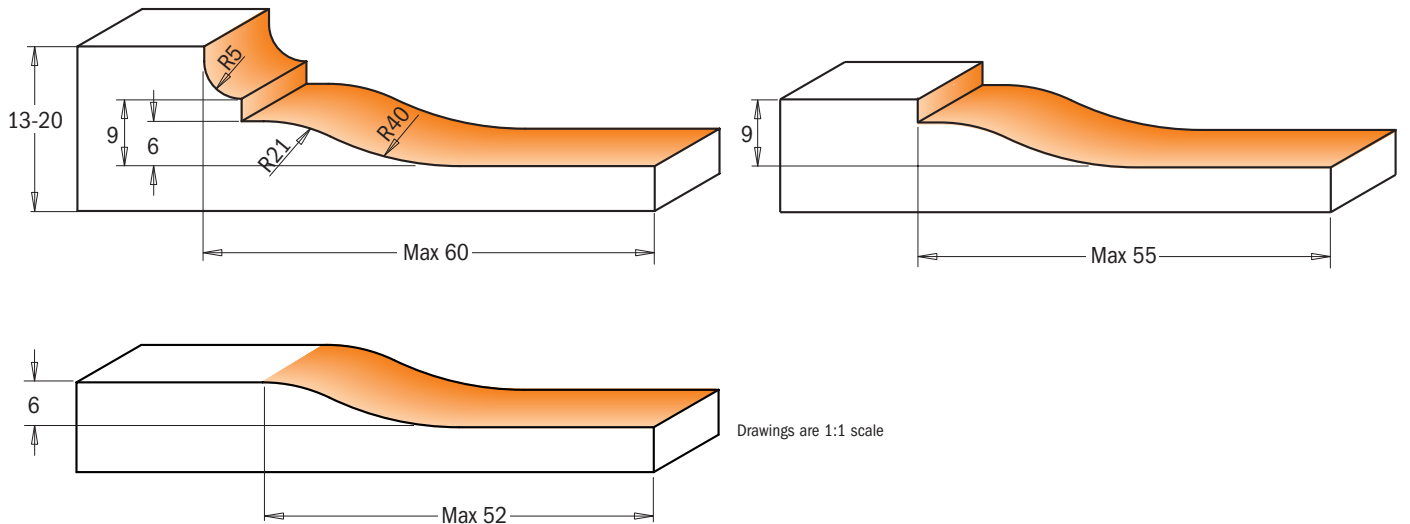
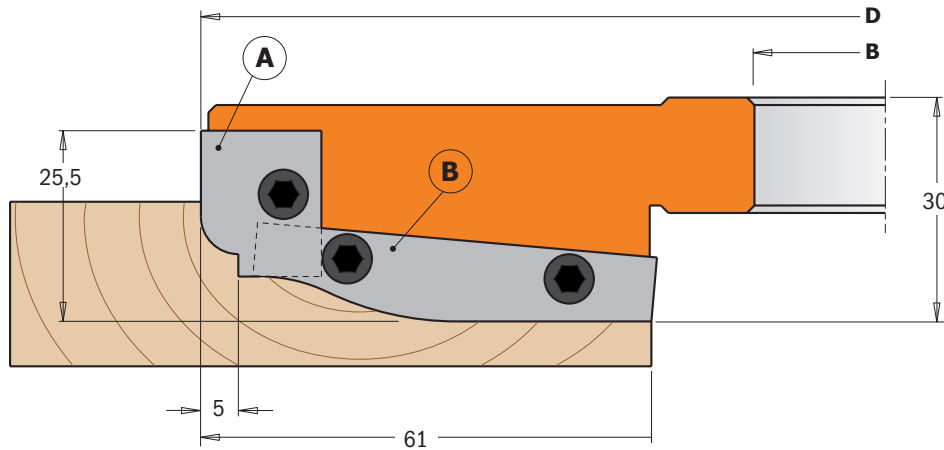
Supplied in a solid plastic box.



D mm	B mm	Z	RPM	ORDER NO.	Spare parts				
183	30	2+2	4100~7000	694.013.30	✚ x2	 16x11x9,5mm	✚ x2	 53x11x9,5mm	
183	31,75	2+2	4100~7000	694.013.31	695.013.A1	695.999.16	695.013.A2	695.999.53	990.066.00
183	35	2+2	4100~7000	694.013.35	695.013.A1	695.999.16	695.013.A2	695.999.53	990.066.00
200	40	2+2	3800~6400	694.013.40	695.013.A1	695.999.16	695.013.A2	695.999.53	990.066.00
200	50	2+2	3800~6400	694.013.50	695.013.A1	695.999.16	695.013.A2	695.999.53	990.066.00

Spare parts **991.083.00** 3x90x135mm hex key

1 piece rail & stile cutter heads



694.014



These are unique products made by combining two cutter heads, ideal for making furniture doors and drawers. By adjusting the height of the head it is possible to cut two perfectly fitting profiles with no waste of time or efforts to move the fence or to replace the tool. Save money by purchasing one single head and improve your production's efficiency. For use on spindle moulders. Perfect on hardwood and panels with thickness between 22mm and 25mm.

TECHNICAL DETAILS:

- Hard aluminium alloy body with high resistance to tensile and yield stress
- 2 HWM Knives type (A) 40x24,5x2mm [Z2]
- Tools for manual feed MAN
- Pins for the automatic positioning of the knives

Supplied in a solid plastic box.

Standard

Pair of knives **695.014A**

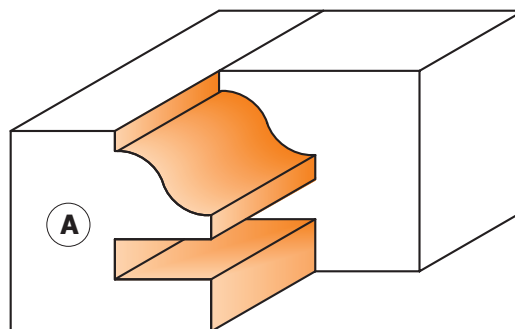
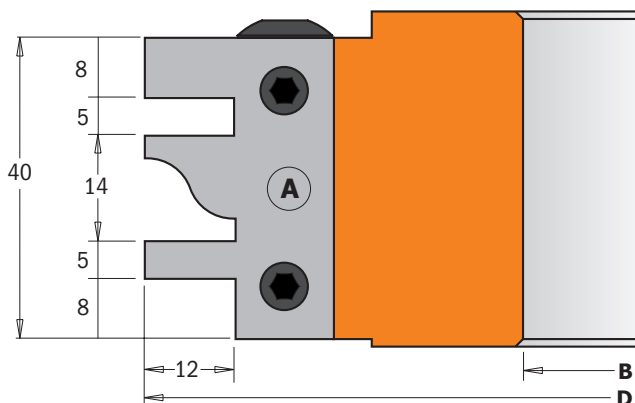

Drawing is 1:1 scale

Optional

Pair of knives **695.014B**

Pair of knives **695.014C**

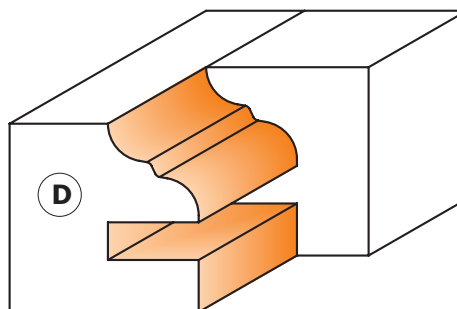
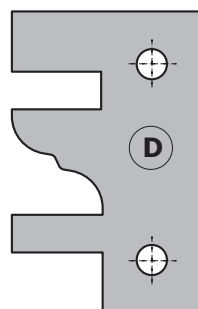
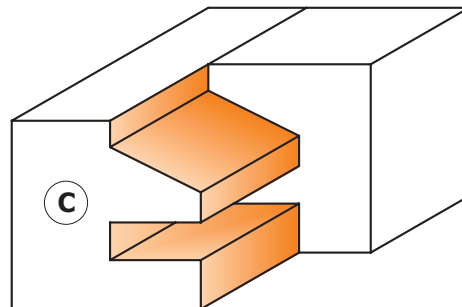
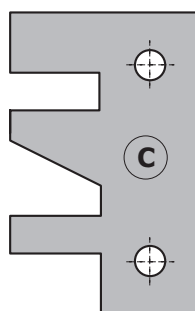
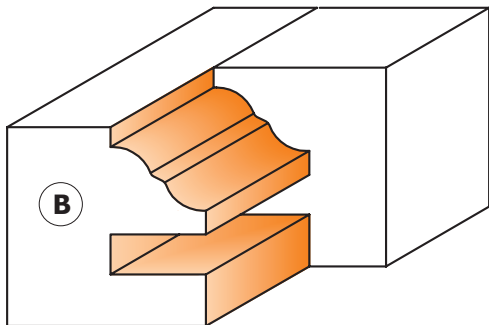
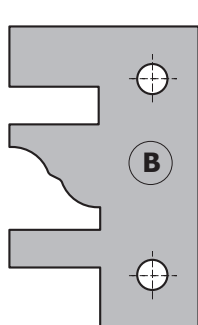

Drawings are 1:1 scale

Pair of knives **695.014D**

D mm	B mm	Z	RPM	ORDER NO.	Spare parts			
120	30	2	6400~10500	694.014.30	x2			
120	31,75	2	6400~10500	694.014.31	695.014A	695.999.39	990.066.00	991.067.00
120	35	2	6400~10500	694.014.35	695.014A	695.999.39	990.066.00	991.067.00
120	40	2	6400~10500	694.014.40	695.014A	695.999.39	990.066.00	991.067.00
130	50	2	5900~9700	694.014.50	695.014A	695.999.39	990.066.00	991.067.00

Optional

695.014B	40x24,5x2mm pair of knives type (B)
695.014C	40x24,5x2mm pair of knives type (C)
695.014D	40x24,5x2mm pair of knives type (D)

Profile and counter profile cutter head sets

Saw blades

Jig saw blades

Tools with bore & Knives

Router bits & sets

CNC router cutter & chucks

Industrial dowel drills

Bits for hand power tools

Power tools & accessories

Display cabinets & spare parts



694.015

These versatile sets have been designed to make furniture and doors on soft and hardwood. It allows the insertion of five different knives to produce the most popular and classical profiles. The adjustable cutter, included in the set, can also be used individually to carry out grooves from 8mm 15mm thick. For use on spindle moulders. Perfect on solid wood and panels with maximum 48mm (1-7/8") in thickness.

TECHNICAL DETAILS:

- Hard aluminium alloy body with high resistance to tensile and yield stress for cutter heads (1 & 2);
- Super-strength steel body for cutter head (3)
- 2 HWM knives type (A1) 25x29,8x2mm [Z2]
- 2 HWM knives type (A2) 25x29,8x2mm [Z2]
- 4 HWM knives 7,65x12x1,5mm [Z4]
- 4 HWM knives 14x14x2m for heads type (1 & 2)
- 12 spacer rings from 0,1 to 3mm for heads type (1 & 2)
- 12 spacer rings from 0,1 to 2mm for heads type (3)
- Tools for manual feed MAN
- Pins for the automatic positioning of the knives

Supplied in a solid plastic box.

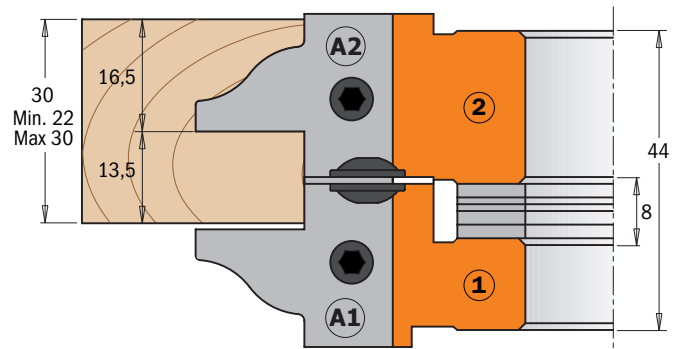
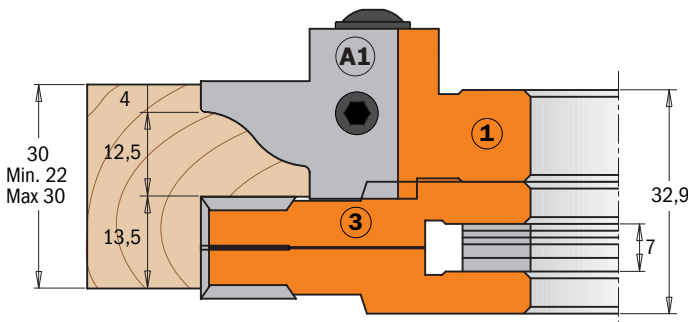
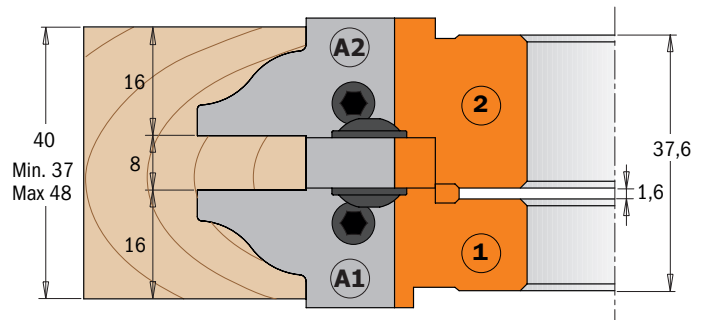
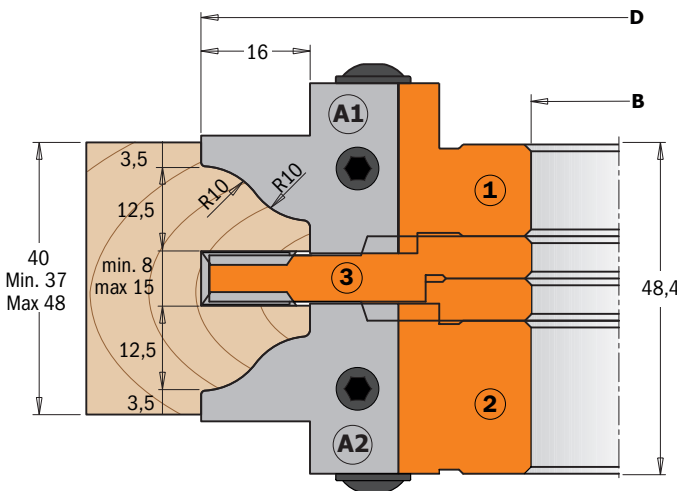

D mm	B mm	Z + V	RPM	ORDER NO.
132	30	2+2	5700~9500	694.015.30
132	31,75	2+2	5700~9500	694.015.31
132	35	2+2	5700~9500	694.015.35
147	40	2+2	5100~8500	694.015.40
147	50	2+2	5100~8500	694.015.50

Spare parts

9	10,6	10,6
695.998.01	695.998.21	695.998.30
695.998.02	695.998.22	695.998.31
695.998.03	695.998.23	695.998.35
695.998.04	695.998.24	695.998.40
695.998.05	695.998.25	

Spare parts

Head type (1)

- 695.015.A1** 25x29,8x2mm HWM pair of knives (A1)
- 695.015.B1** 25x29,8x2mm HWM pair of knives (B1)
- 695.015.C1** 25x29,8x2mm HWM pair of knives (C1)
- 695.015.D1** 25x29,8x2mm HWM pair of knives (D1)
- 695.015.E1** 25x29,8x2mm HWM pair of knives (E1)
- 695.999.23** 23x11x9,5mm wedge for knives
- 990.066.00** M6x16mm screw
- 991.067.00** 3mm hex key

Head type (2)

- 695.015.A2** 25x29,8x2mm HWM pair of knives (A2)
- 695.015.B2** 25x29,8x2mm HWM pair of knives (B2)
- 695.015.C2** 25x29,8x2mm HWM pair of knives (C2)
- 695.015.D2** 25x29,8x2mm HWM pair of knives (D2)
- 695.015.E2** 25x29,8x2mm HWM pair of knives (E2)
- 695.999.24** 23x11x9,5mm wedge for knives
- 990.066.00** M6x16mm screws
- 991.067.00** 3mm hex key

Head type (3)

- 790.076.00** 7,65x12x1,5mm HWM knives
- 695.999.07** 6,8x11x9,5mm wedge for knives
- 990.063.00** M5x18mm screw
- 991.072.00** T20 hex key
- 790.140.00** 14x14x2mm HWM Knives
- 990.080.00** M5x6,5mm screw
- 991.073.00** T25 hex key

Standard

Pair of knives **695.015.A1** - Pair of knives **695.015.A2**

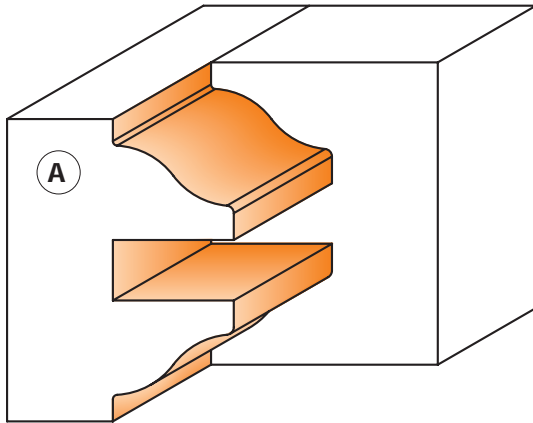

Drawings are 1:1 scale

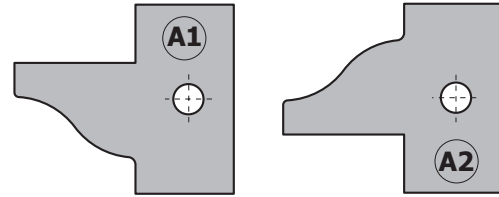

Optional

Pair of knives **695.015.B1**
Pair of knives **695.015.B2**

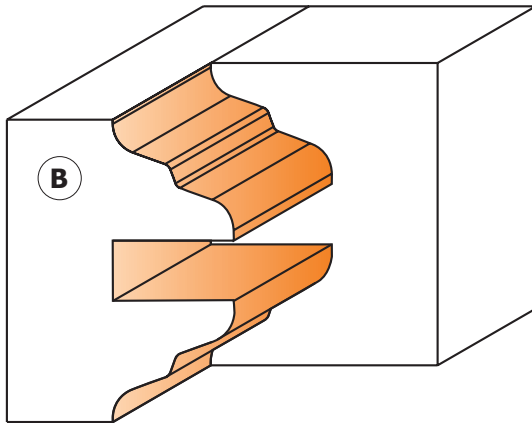
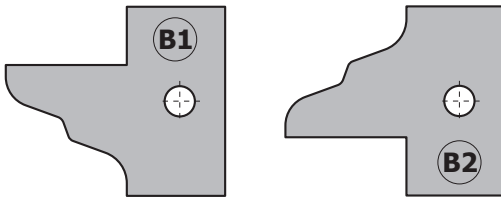

Pair of knives **695.015.C1**
Pair of knives **695.015.C2**

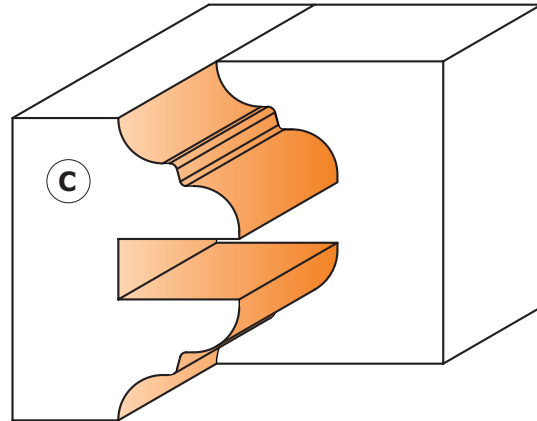
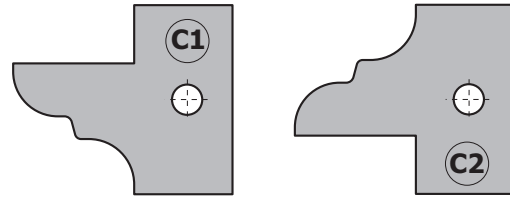

Pair of knives **695.015.D1**
Pair of knives **695.015.D2**

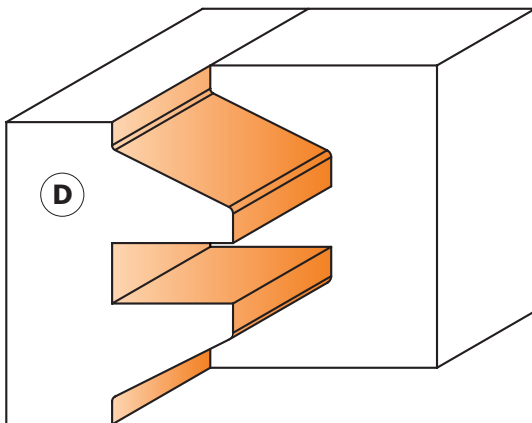
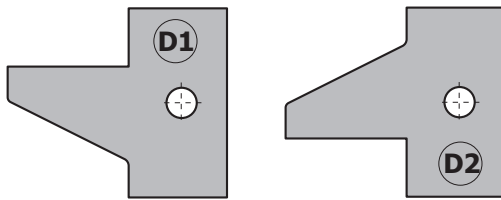

Pair of knives **695.015.E1**
Pair of knives **695.015.E2**

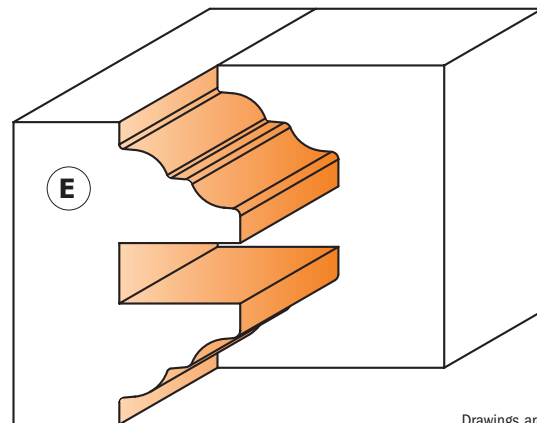
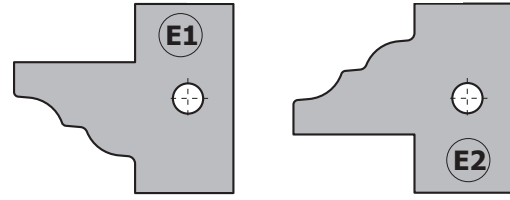

Drawings are 1:1 scale

Cutter heads without limiters



692

CMT cutter heads guarantee excellent performance for all your projects. For use on all types of moulder and spindle moulder machines.

TECHNICAL DETAILS:

- Hard aluminium or steel alloy cutter head without limiters, highly resistant to tensile and yield stress;
- Pair of universal straight knives;
- Tools for mechanical feed (MEC);
- Pins for the automatic positioning of the knives;
- Possibility to use knives with a height of 40mm or 50mm (order no. 690);

Supplied in a solid plastic box to contain up to 12 couples of knives.

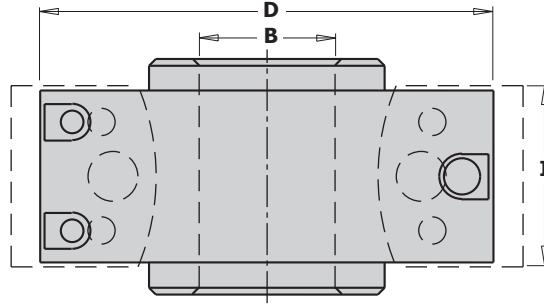
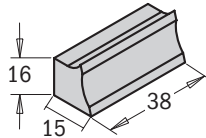

D mm	I mm	B mm	RPM	ORDER NO. Steel body	ORDER NO. Aluminium body	Spare parts		
78	40	19,05	7000~9000		692.078.19*			
78	40	30	7000~9000		692.078.30*	692.999.01	990.064.00	991.064.00
100	40-50	25,4	5500~8400		692.100.26	692.999.01	990.064.00	991.064.00
100	40-50	30	5500~8400	692.101.30	692.100.30	692.999.01	990.064.00	991.064.00
100	40-50	31,75	5500~8400		692.100.31	692.999.01	990.064.00	991.064.00
100	40-50	35	5500~8400	692.101.35	692.100.35	692.999.01	990.064.00	991.064.00
120	40-50	50	4800~7400	692.121.50	692.120.50	692.999.01	990.064.00	991.064.00

*For safety reasons we recommend the use of knives with a 40mm height only.

Cutter heads with limiters



693

CMT cutter heads guarantee excellent performance for all your projects. For use on all types of moulder and spindle moulder machines.

TECHNICAL DETAILS:

- Hard aluminium or steel alloy cutter head without limiters, highly resistant to tensile and yield stress;
- Pair of universal straight knives;
- Tools for manual feed (MAN);
- Pins for the automatic positioning of the knives;
- Possibility to use knives with a height of 40mm or 50mm (order no. 690) and limiters (order no. 691).

Made in compliance with the European Normative EN 847-1

Supplied in a solid plastic box to contain up to 12 couples of knives.

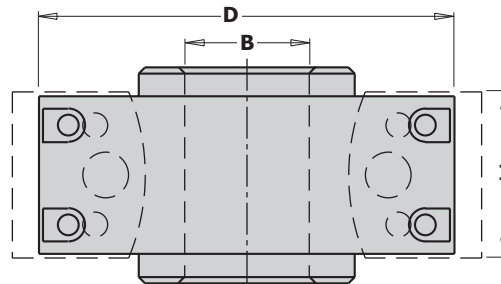
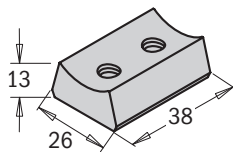

D mm	I mm	B mm	RPM	ORDER NO. Steel body	ORDER NO. Aluminium body	Spare parts		
78	40	30	7000~9000	693.078.30				
100	40-50	30	5500~8400	693.101.30	693.100.30	693.999.01	990.065.00	991.064.00
100	40-50	31,75	5500~8400		693.100.31	693.999.01	990.065.00	991.064.00
100	40-50	35	5500~8400	693.101.35	693.100.35	693.999.01	990.065.00	991.064.00
120	40-50	50	4800~7400	693.121.50	693.120.50	693.999.01	990.065.00	991.064.00

13 piece multiprofile cutter head sets without limiters

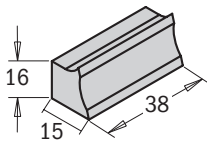

692



These sets are ideal for the professional woodworker for making joints and frames and include 3 essential profiles to produce kitchen doors. The cutter heads included in the sets allow the insertion of knives with a height of either 40mm or 50mm. Both cutter head and knives are stored in solid plastic cases to prevent damage.

These sets include:

- 1 cutter head in hard aluminium alloy with pins for the automatic positioning of the knives;
- 13 pairs of knives with a cutting height of 40mm.

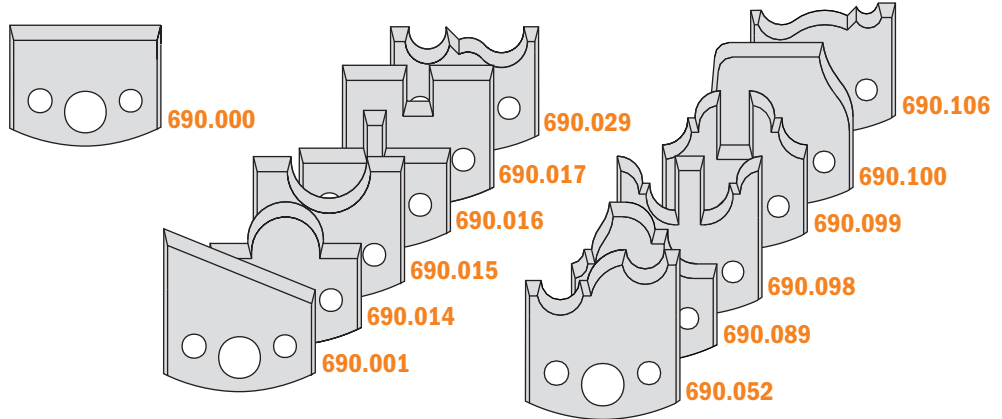

D mm	I mm	B mm	RPM	ORDER NO.	Spare parts		
78	40	19,05	7000~9000	692.013.09			
78	40	30	7000~9000	692.013.01	692.999.01	990.064.00	991.064.00
100	40	25,4	5500~8400	692.013.10	692.999.01	990.064.00	991.064.00
100	40	30	5500~8400	692.013.02	692.999.01	990.064.00	991.064.00
100	40	31,75	5500~8400	692.013.11	692.999.01	990.064.00	991.064.00
100	40	35	5500~8400	692.013.03	692.999.01	990.064.00	991.064.00
120	40	50	4800~7400	692.013.04	692.999.01	990.064.00	991.064.00

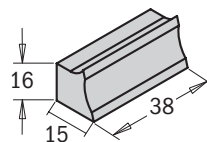

692



These sets are ideal for the professional woodworker and include 13 profile knives for making joints, frames, multiple profiles, moldings and chamfers. The cutter head included in the sets allow the insertion of knives with a height of either 40mm or 50mm. Both cutter head and knives are stored in solid plastic cases to prevent damage.

These sets include:

- 1 cutter head in hard aluminium alloy with pins for the automatic positioning of the knives;
- 13 pairs of knives with a cutting height of 40mm.

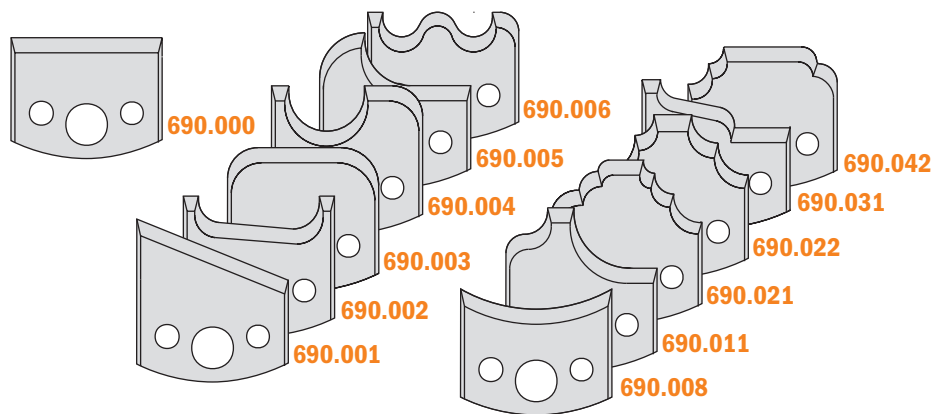

D mm	I mm	B mm	RPM	ORDER NO.	Spare parts		
78	40	19,05	7000~9000	692.013.12			
78	40	30	7000~9000	692.013.05	692.999.01	990.064.00	991.064.00
100	40	25,4	5500~8400	692.013.13	692.999.01	990.064.00	991.064.00
100	40	30	5500~8400	692.013.06	692.999.01	990.064.00	991.064.00
100	40	31,75	5500~8400	692.013.14	692.999.01	990.064.00	991.064.00
100	40	35	5500~8400	692.013.07	692.999.01	990.064.00	991.064.00
120	40	50	4800~7400	692.013.08	692.999.01	990.064.00	991.064.00

7 piece multiprofile cutter head sets with limiters

Saw blades
Jig saw blades
Tools with bore & Knives
Router bits & sets
CNC router cutter & chucks
Industrial dowel drills
Bits for hand power tools
Power tools & accessories
Display cabinets & spare parts



693

The professional woodworker has now the chance to make kitchen doors with a horizontal profile and male-and-female joints with two pairs of cutters. In fact, along with 7 profiled knives these sets also contains a specially designed cutter head that allows the insertion of knives with a height of either 40mm or 50mm, and safety limiters produced in compliance with the European normative EN 847-1. Both cutter head and knives are stored in solid plastic cases to prevent damage.

These sets include:

- 1 cutter head in hard aluminium alloy allowing the insertion of straight knives, limiters and pins for the automatic positioning of the knives;
- 7 pairs of knives with 40mm of cutting;
- 7 pairs of relative limiters.

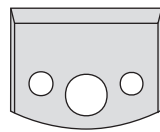
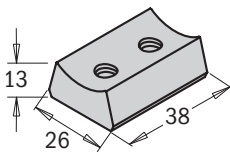

690.000
691.000

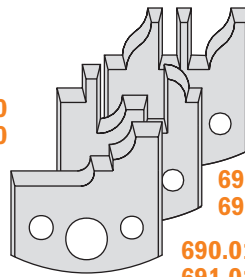

690.096
691.096

690.019
691.019

690.097
691.097

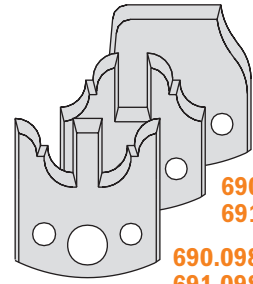

690.100
691.100

690.099
691.099

690.098
691.098

Spare parts



D mm	I mm	B mm	RPM	ORDER NO.	693.999.01	990.065.00	991.064.00
100	40	30	5500~8400	693.013.01	693.999.01	990.065.00	991.064.00
100	40	35	5500~8400	693.013.02	693.999.01	990.065.00	991.064.00
120	40	50	4800~7400	693.013.03	693.999.01	990.065.00	991.064.00



693

CMT has designed these sets containing 7 profiled knives and a cutter head for making joints, frames and chamfers. The cutter heads allow the insertion of knives with a height of either 40mm or 50mm and safety limiters produced in compliance with the European normative EN 847-1. Both cutter head and knives are stored in solid plastic cases to prevent damage.

These sets include:

- 1 cutter head in hard aluminium alloy allowing the insertion of straight knives, limiters and pins for the automatic positioning of the knives;
- 7 pairs of knives with 40mm of cutting;
- 7 pairs of relative limiters.

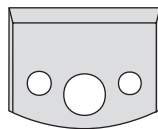
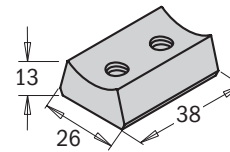

690.000
691.000

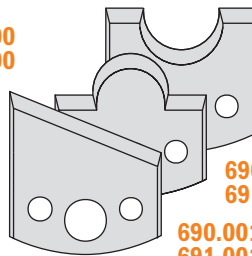

690.015
691.015

690.014
691.014

690.001
691.001

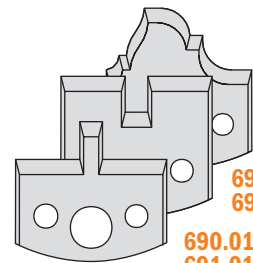

690.089
691.089

690.017
691.017

690.016
691.016

Spare parts



D mm	I mm	B mm	RPM	ORDER NO.	693.999.01	990.065.00	991.064.00
100	40	30	5500~8400	693.013.04	693.999.01	990.065.00	991.064.00
100	40	35	5500~8400	693.013.05	693.999.01	990.065.00	991.064.00
120	40	50	4800~7400	693.013.06	693.999.01	990.065.00	991.064.00

Profile knives and limiters

Cutting length=40mm Thickness=4mm

SP

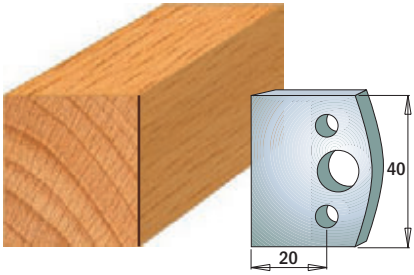

Pair of knives **690.000**
Pair of limiters **691.000**

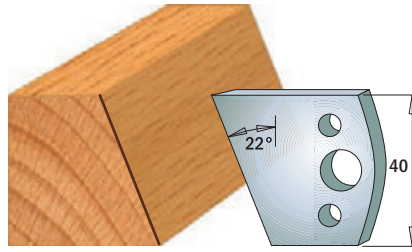

Pair of knives **690.001**
Pair of limiters **691.001**

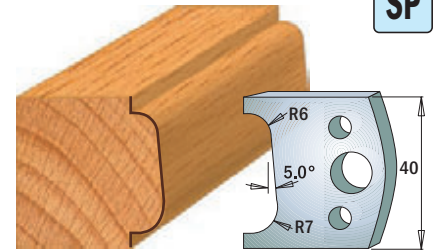

Pair of knives **690.002**
Pair of limiters **691.002**

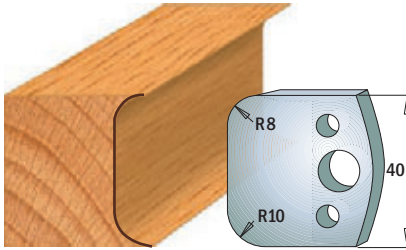

Pair of knives **690.003**
Pair of limiters **691.003**

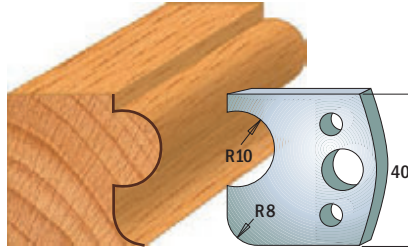

Pair of knives **690.004**
Pair of limiters **691.004**

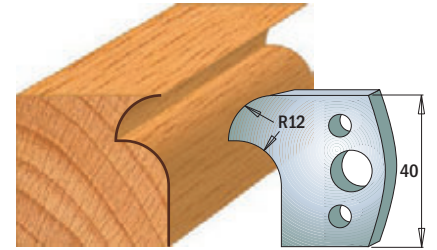

Pair of knives **690.005**
Pair of limiters **691.005**

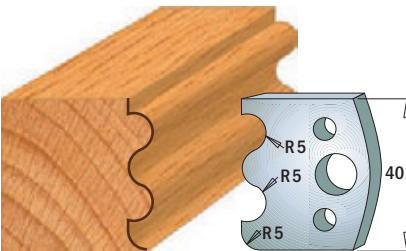

Pair of knives **690.006**
Pair of limiters **691.006**

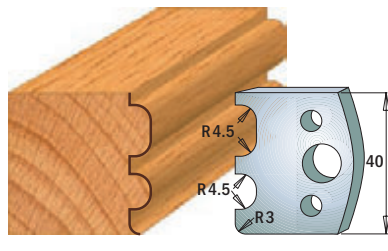

Pair of knives **690.007**
Pair of limiters **691.007**

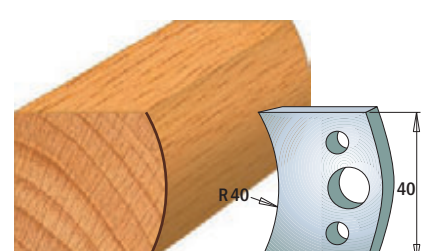

Pair of knives **690.008**
Pair of limiters **691.008**

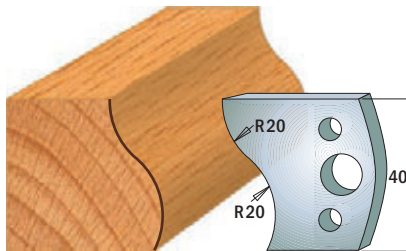

Pair of knives **690.009**
Pair of limiters **691.009**

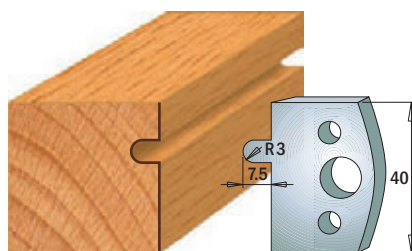

Pair of knives **690.010**
Pair of limiters **691.010**

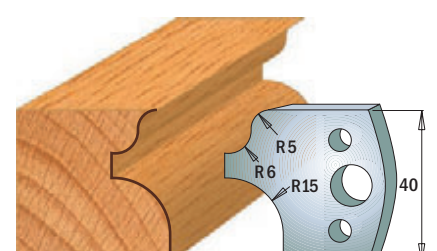

Pair of knives **690.011**
Pair of limiters **691.011**

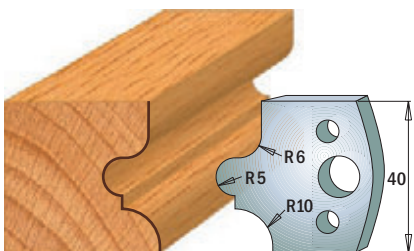

Pair of knives **690.012**
Pair of limiters **691.012**

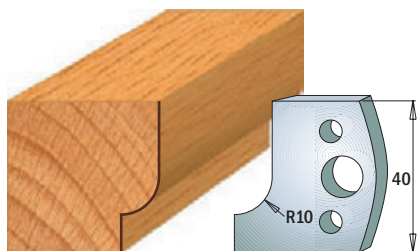

Pair of knives **690.013**
Pair of limiters **691.013**

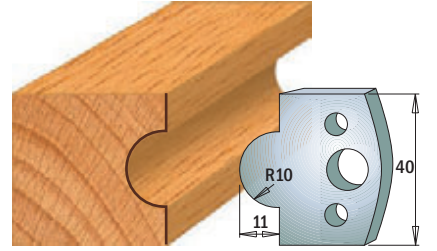

Pair of knives **690.014**
Pair of limiters **691.014**

Note: all knives and limiters only available in pairs

Drawings are 1:2 scale

Dimensions in mm.

Profile knives and limiters

Cutting length=40mm Thickness=4mm

SP

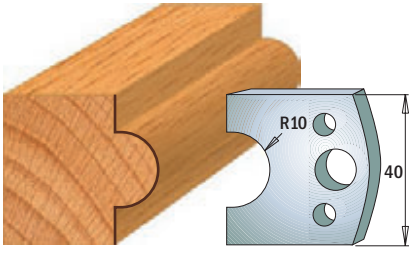

Pair of knives **690.015**
Pair of limiters **691.015**

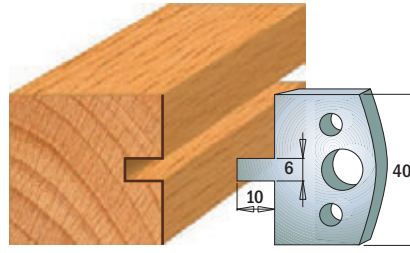

Pair of knives **690.016**
Pair of limiters **691.016**

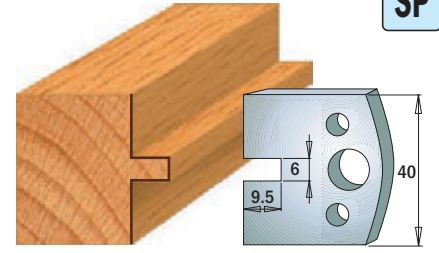

Pair of knives **690.017**
Pair of limiters **691.017**

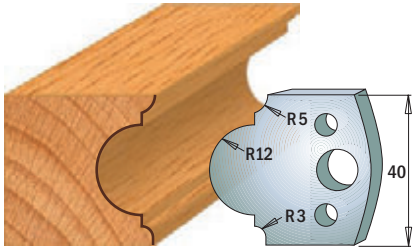

Pair of knives **690.018**
Pair of limiters **691.018**

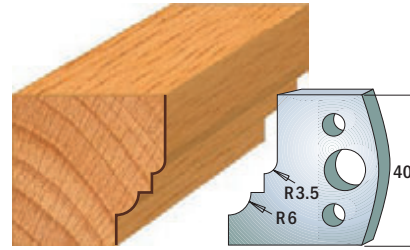

Pair of knives **690.019**
Pair of limiters **691.019**

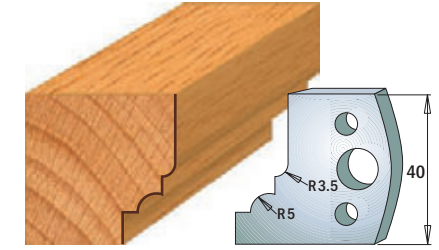

Pair of knives **690.020**
Pair of limiters **691.020**

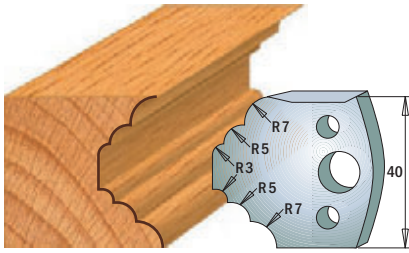

Pair of knives **690.021**
Pair of limiters **691.021**

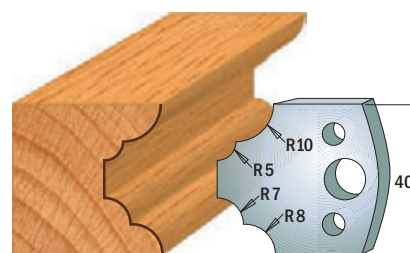

Pair of knives **690.022**
Pair of limiters **691.022**

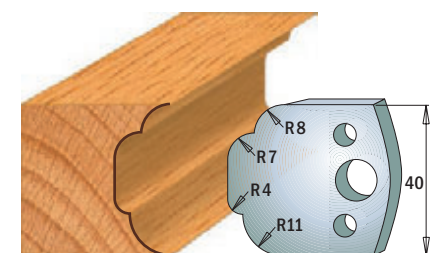

Pair of knives **690.023**
Pair of limiters **691.023**

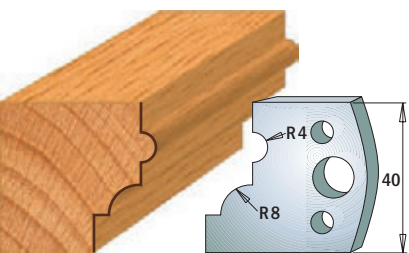

Pair of knives **690.024**
Pair of limiters **691.024**

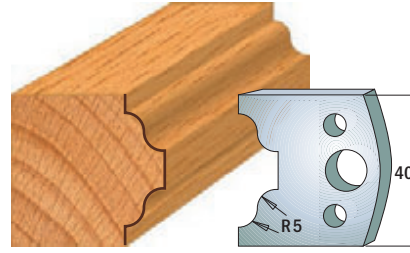

Pair of knives **690.025**
Pair of limiters **691.025**

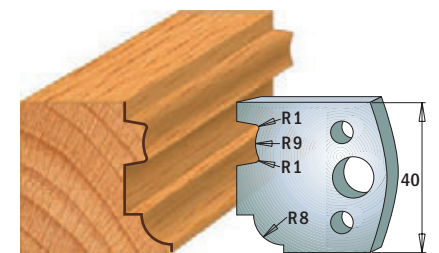

Pair of knives **690.026**
Pair of limiters **691.026**

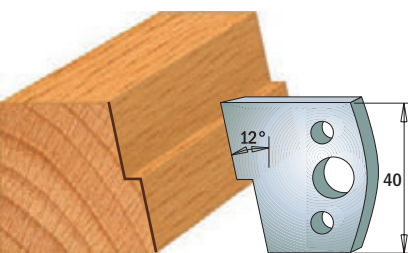

Pair of knives **690.027**
Pair of limiters **691.027**

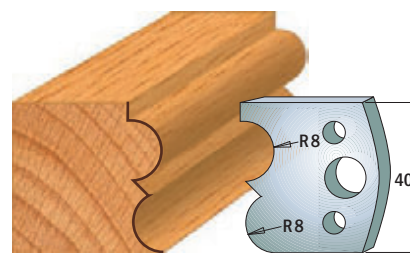

Pair of knives **690.028**
Pair of limiters **691.028**

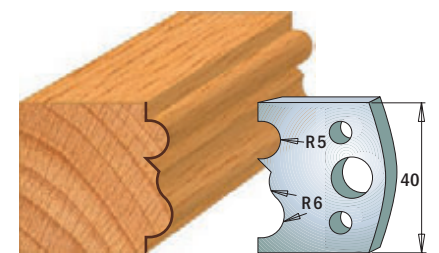

Pair of knives **690.029**
Pair of limiters **691.029**

Note: all knives and limiters only available in pairs

Drawings are 1:2 scale

Dimensions in mm.

Saw blades

Jig saw blades

Tools with bore & Knives

Router bits & sets

CNC router cutter & chucks

Industrial dowel drills

Bits for hand power tools

Power tools & accessories

Display cabinets & spare parts

Profile knives and limiters

Cutting length=40mm Thickness=4mm



SP

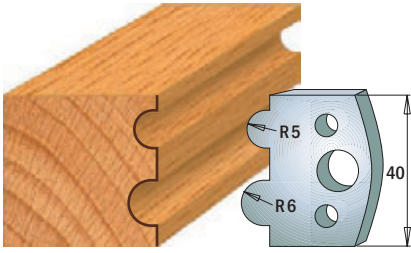

Pair of knives **690.030**
Pair of limiters **691.030**

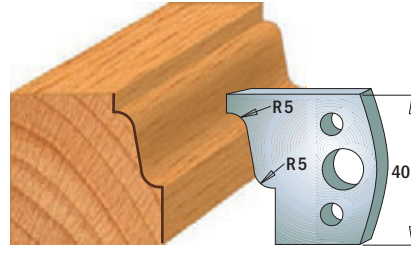

Pair of knives **690.031**
Pair of limiters **691.031**

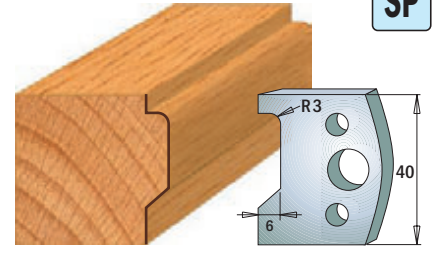

Pair of knives **690.032**
Pair of limiters **691.032**

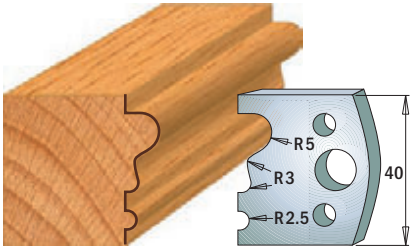

Pair of knives **690.033**
Pair of limiters **691.033**

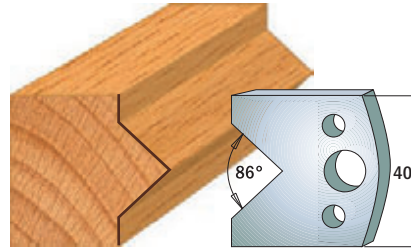

Pair of knives **690.034**
Pair of limiters **691.034**

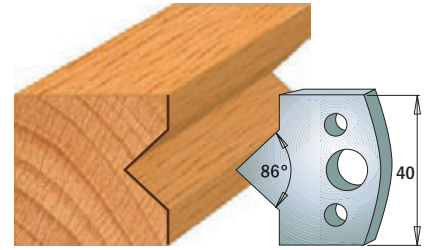

Pair of knives **690.035**
Pair of limiters **691.035**

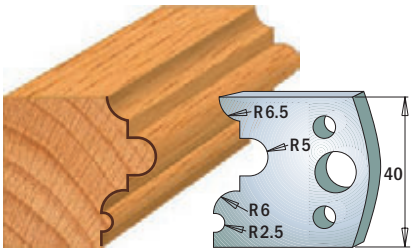

Pair of knives **690.036**
Pair of limiters **691.036**

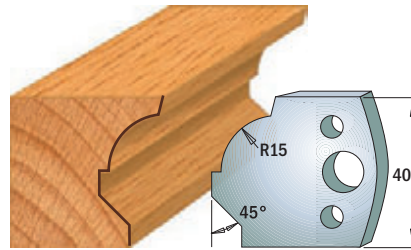

Pair of knives **690.037**
Pair of limiters **691.037**

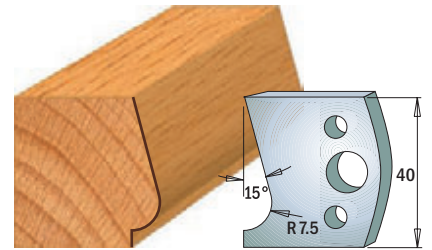

Pair of knives **690.038**
Pair of limiters **691.038**

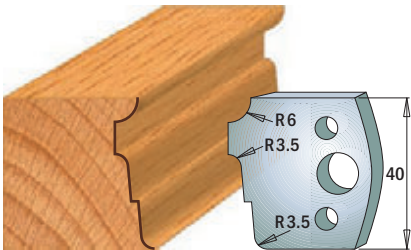

Pair of knives **690.039**
Pair of limiters **691.039**

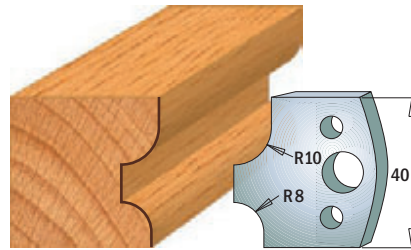

Pair of knives **690.040**
Pair of limiters **691.040**

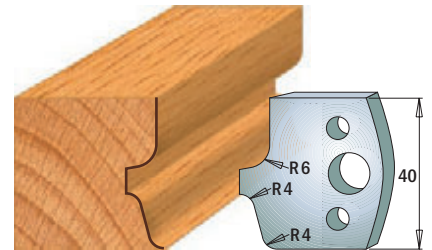

Pair of knives **690.041**
Pair of limiters **691.041**

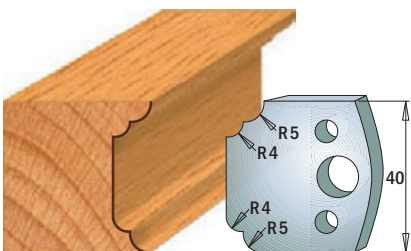

Pair of knives **690.042**
Pair of limiters **691.042**

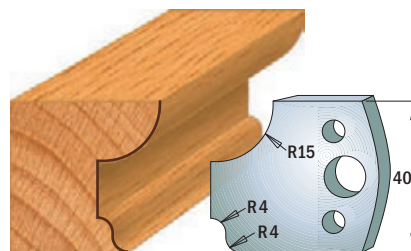

Pair of knives **690.043**
Pair of limiters **691.043**

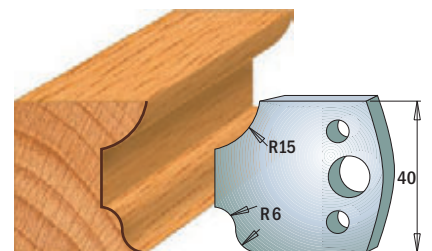

Pair of knives **690.044**
Pair of limiters **691.044**

Note: all knives and limiters only available in pairs

Drawings are 1:2 scale

Dimensions in mm.

Profile knives and limiters

Cutting length=40mm Thickness=4mm

SP

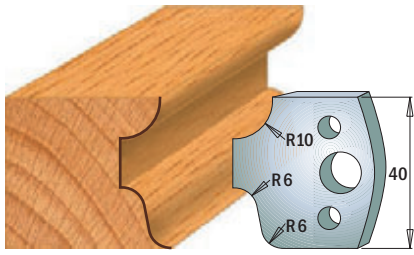

Pair of knives **690.045**
Pair of limiters **691.045**

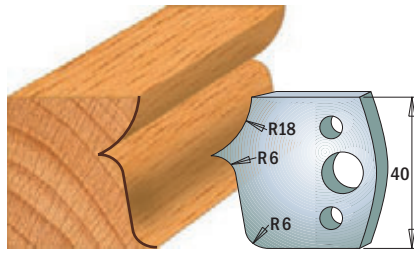

Pair of knives **690.046**
Pair of limiters **691.046**

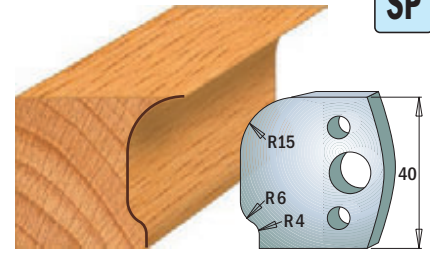

Pair of knives **690.047**
Pair of limiters **691.047**

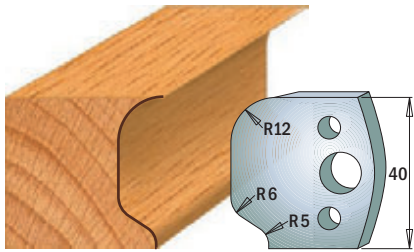

Pair of knives **690.048**
Pair of limiters **691.048**

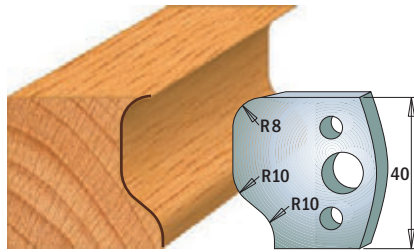

Pair of knives **690.049**
Pair of limiters **691.049**

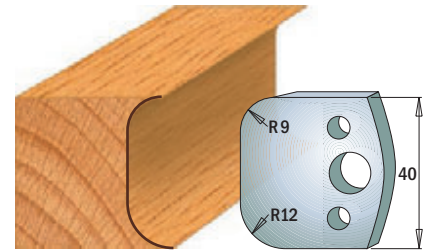

Pair of knives **690.050**
Pair of limiters **691.050**

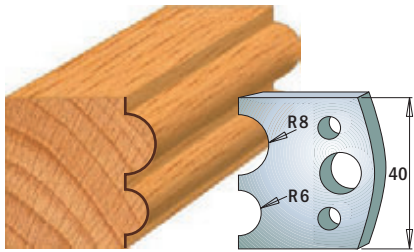

Pair of knives **690.051**
Pair of limiters **691.051**

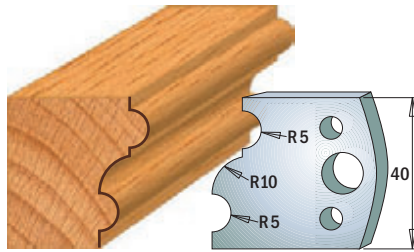

Pair of knives **690.052**
Pair of limiters **691.052**

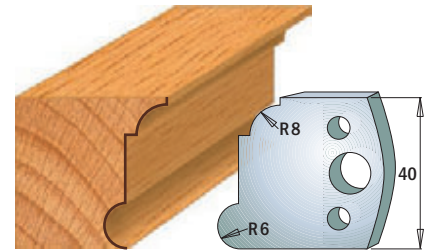

Pair of knives **690.053**
Pair of limiters **691.053**

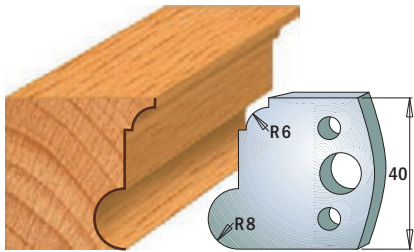

Pair of knives **690.054**
Pair of limiters **691.054**

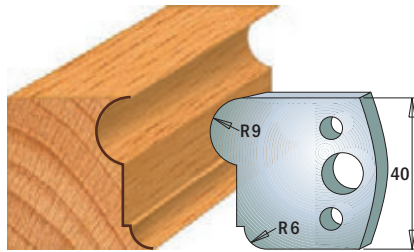

Pair of knives **690.055**
Pair of limiters **691.055**

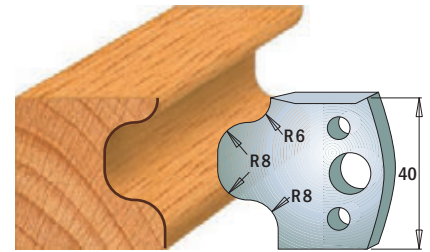

Pair of knives **690.056**
Pair of limiters **691.056**

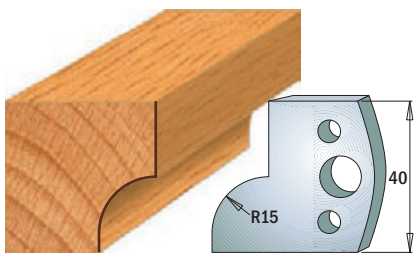

Pair of knives **690.057**
Pair of limiters **691.057**

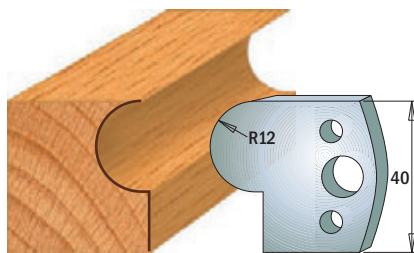

Pair of knives **690.058**
Pair of limiters **691.058**

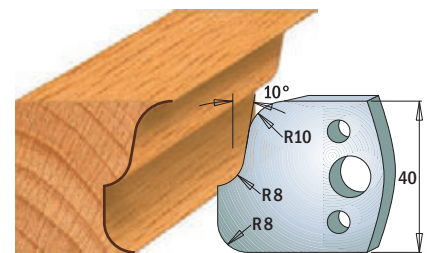

Pair of knives **690.059**
Pair of limiters **691.059**

Note: all knives and limiters only available in pairs

Drawings are 1:2 scale

Dimensions in mm.

Saw blades

Jig saw blades

Tools with bore & Knives

Router bits & sets

CNC router cutter & chucks

Industrial dowel drills

Bits for hand power tools

Power tools & accessories

Display cabinets & spare parts

Profile knives and limiters

Cutting length=40mm Thickness=4mm

SP

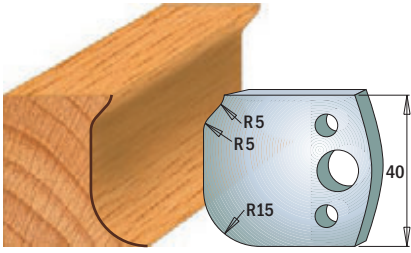

Pair of knives **690.060**
Pair of limiters **691.060**

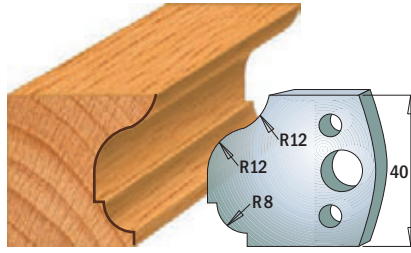

Pair of knives **690.061**
Pair of limiters **691.061**

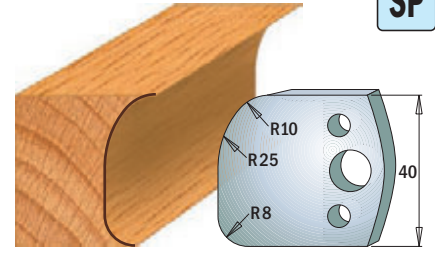

Pair of knives **690.062**
Pair of limiters **691.062**

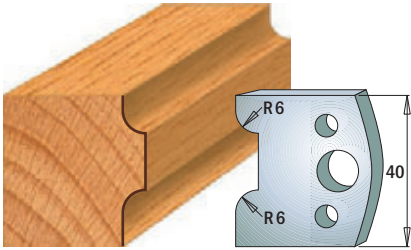

Pair of knives **690.063**
Pair of limiters **691.063**

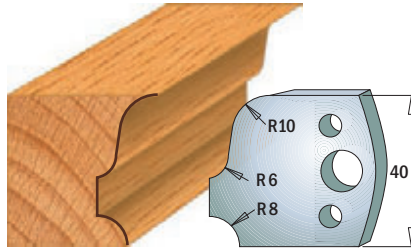

Pair of knives **690.064**
Pair of limiters **691.064**

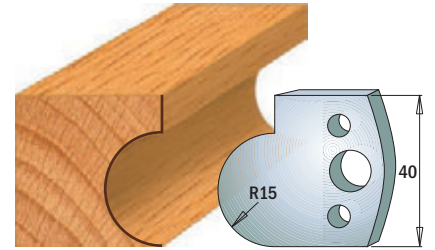

Pair of knives **690.065**
Pair of limiters **691.065**

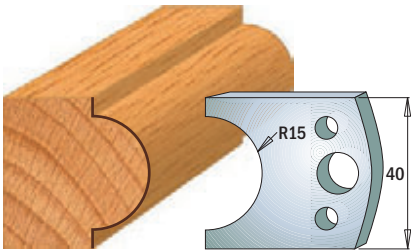

Pair of knives **690.066**
Pair of limiters **691.066**

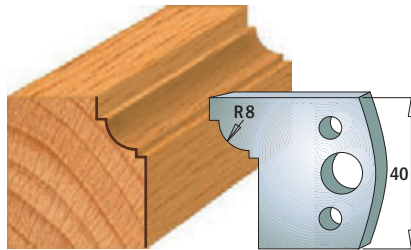

Pair of knives **690.067**
Pair of limiters **691.067**

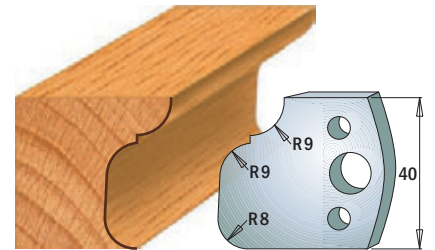

Pair of knives **690.068**
Pair of limiters **691.068**

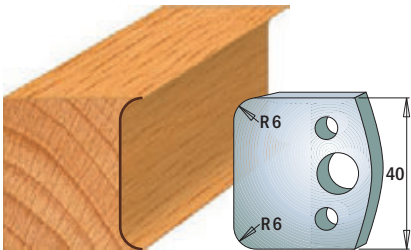

Pair of knives **690.069**
Pair of limiters **691.069**

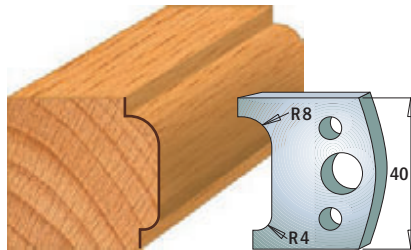

Pair of knives **690.070**
Pair of limiters **691.070**

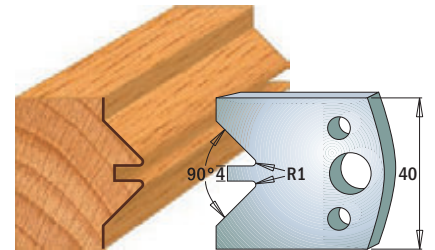

Pair of knives **690.071**
Pair of limiters **691.071**

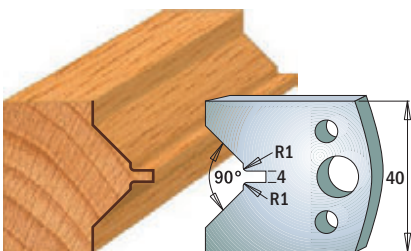

Pair of knives **690.072**
Pair of limiters **691.072**

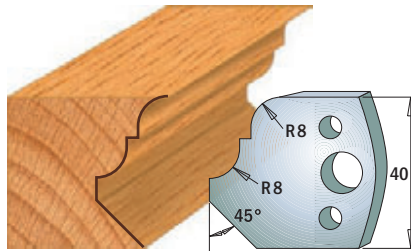

Pair of knives **690.073**
Pair of limiters **691.073**

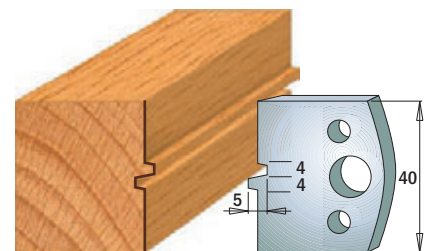

Pair of knives **690.074**
Pair of limiters **691.074**

Note: all knives and limiters only available in pairs

Drawings are 1:2 scale

Dimensions in mm.

Profile knives and limiters

Cutting length=40mm Thickness=4mm

SP

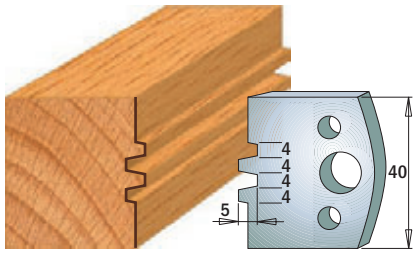

Pair of knives **690.075**
Pair of limiters **691.075**

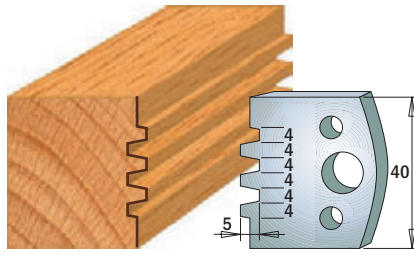

Pair of knives **690.076**
Pair of limiters **691.076**

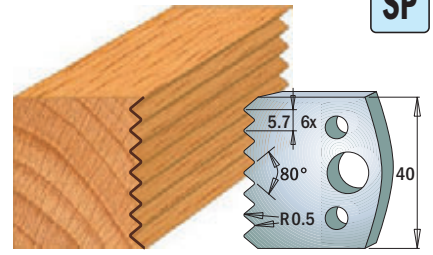

Pair of knives **690.077**
Pair of limiters **691.077**

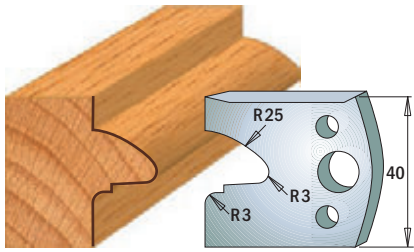

Pair of knives **690.078**
Pair of limiters **691.078**

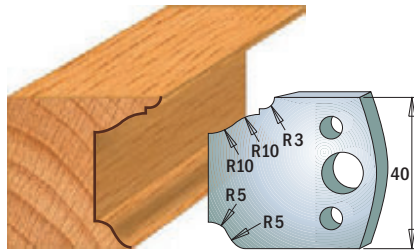

Pair of knives **690.079**
Pair of limiters **691.079**

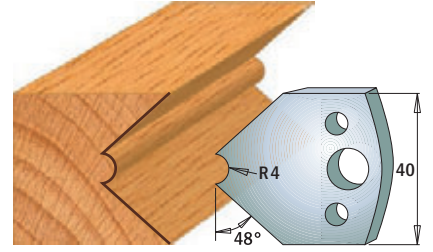

Pair of knives **690.080**
Pair of limiters **691.080**

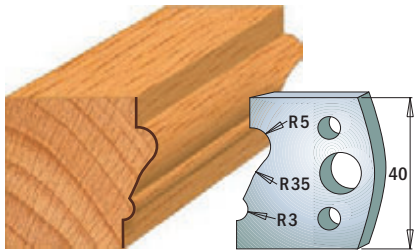

Pair of knives **690.081**
Pair of limiters **691.081**

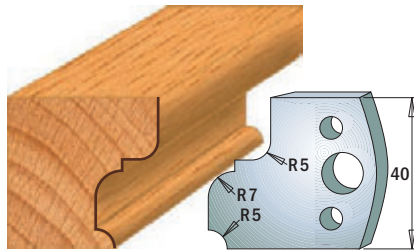

Pair of knives **690.082**
Pair of limiters **691.082**

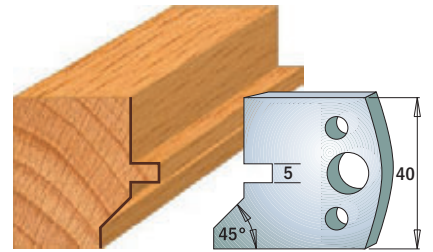

Pair of knives **690.083**
Pair of limiters **691.083**

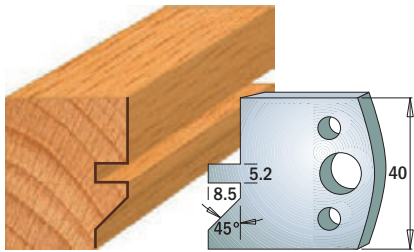

Pair of knives **690.084**
Pair of limiters **691.084**

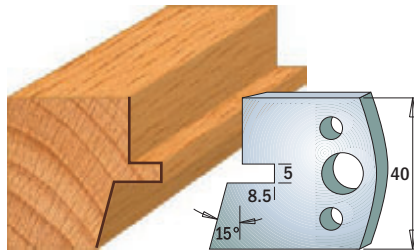

Pair of knives **690.085**
Pair of limiters **691.085**

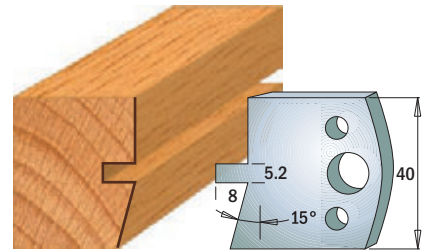

Pair of knives **690.086**
Pair of limiters **691.086**

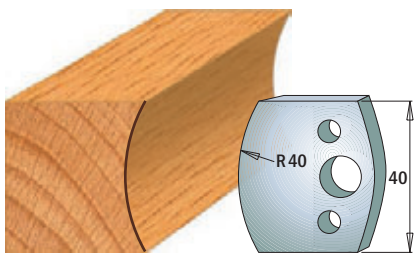

Pair of knives **690.087**
Pair of limiters **691.087**

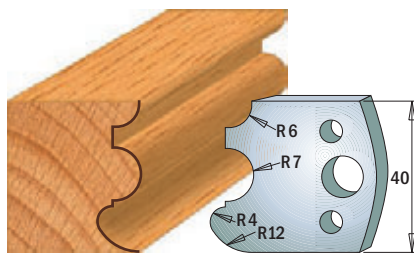

Pair of knives **690.088**
Pair of limiters **691.088**

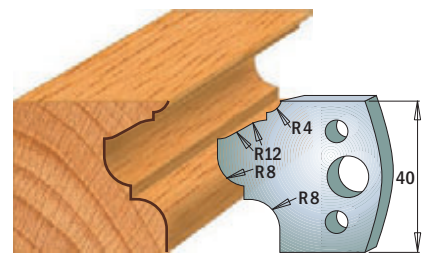

Pair of knives **690.089**
Pair of limiters **691.089**

Note: all knives and limiters only available in pairs

Drawings are 1:2 scale

Dimensions in mm.

Saw blades

Jig saw blades

Tools with bore & Knives

Router bits & sets

CNC router cutter & chucks

Industrial dowel drills

Bits for hand power tools

Power tools & accessories

Display cabinets & spare parts

Profile knives and limiters

Cutting length=40mm Thickness=4mm

SP

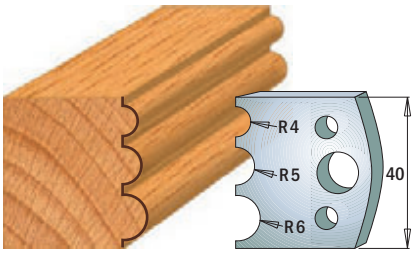

Pair of knives **690.090**
Pair of limiters **691.090**

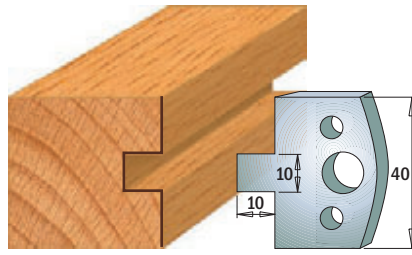

Pair of knives **690.091**
Pair of limiters **691.091**

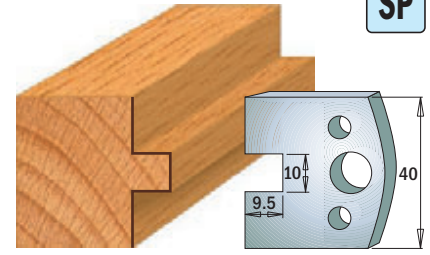

Pair of knives **690.092**
Pair of limiters **691.092**

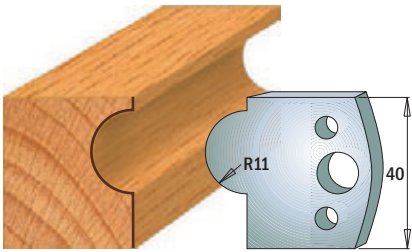

Pair of knives **690.093**
Pair of limiters **691.093**

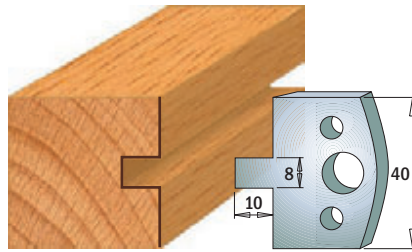

Pair of knives **690.094**
Pair of limiters **691.094**

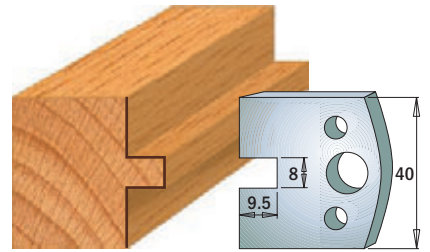

Pair of knives **690.095**
Pair of limiters **691.095**

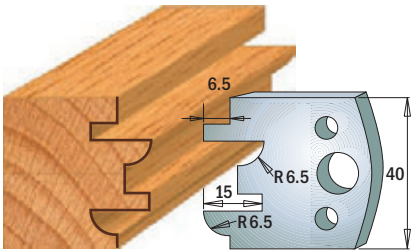

Pair of knives **690.096**
Pair of limiters **691.096**

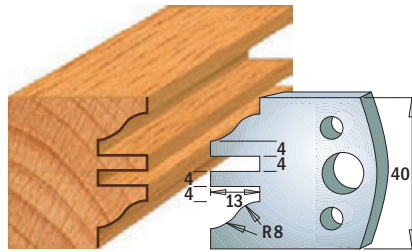

Pair of knives **690.097**
Pair of limiters **691.097**

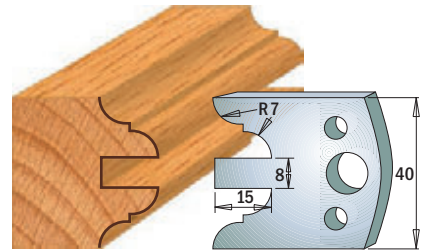

Pair of knives **690.098**
Pair of limiters **691.098**

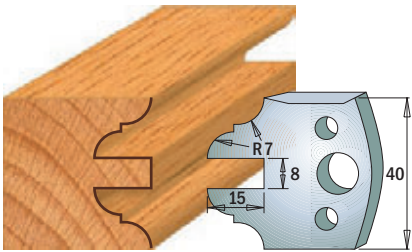

Pair of knives **690.099**
Pair of limiters **691.099**

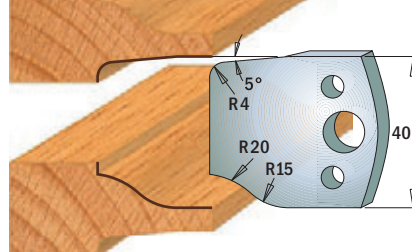

Pair of knives **690.100**
Pair of limiters **691.100**

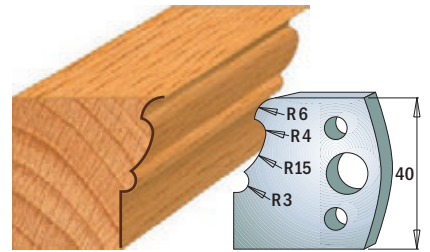

Pair of knives **690.101**
Pair of limiters **691.101**

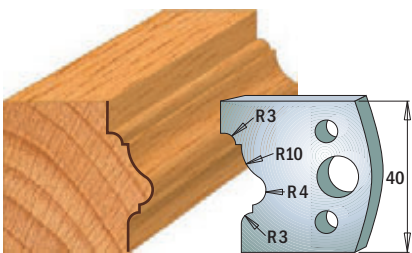

Pair of knives **690.102**
Pair of limiters **691.102**

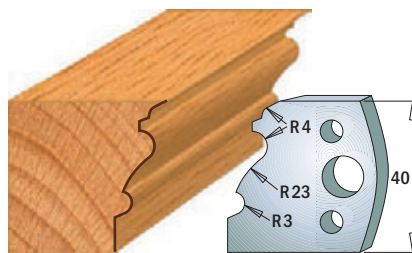

Pair of knives **690.103**
Pair of limiters **691.103**

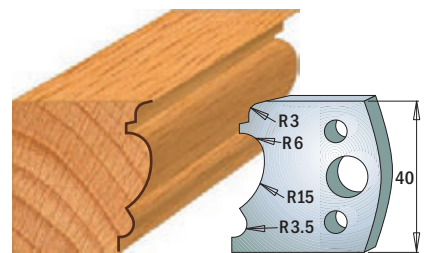

Pair of knives **690.104**
Pair of limiters **691.104**

Note: all knives and limiters only available in pairs

Drawings are 1:2 scale

Dimensions in mm.

Saw blades

Jig saw blades

Tools with bore & Knives

Router bits & sets

CNC router cutter & chucks

Industrial dowel drills

Bits for hand power tools

Power tools & accessories

Display cabinets & spare parts

Profile knives and limiters

Cutting length=40mm Thickness=4mm

SP

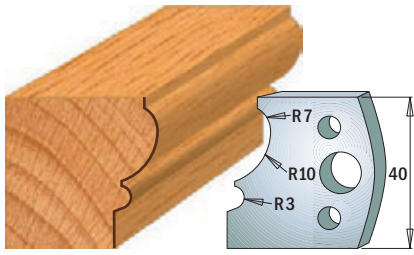

Pair of knives **690.105**
Pair of limiters **691.105**

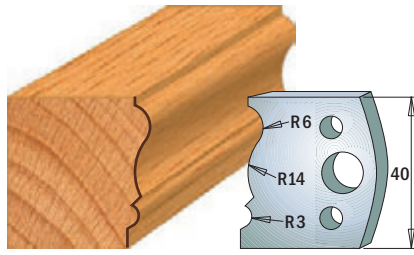

Pair of knives **690.106**
Pair of limiters **691.106**

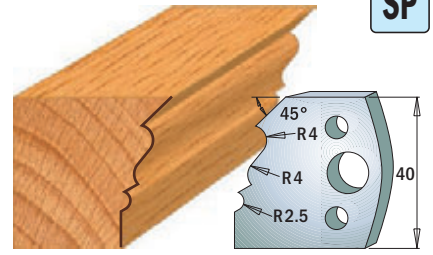

Pair of knives **690.107**
Pair of limiters **691.107**

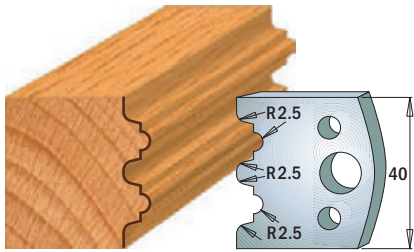

Pair of knives **690.108**
Pair of limiters **691.108**

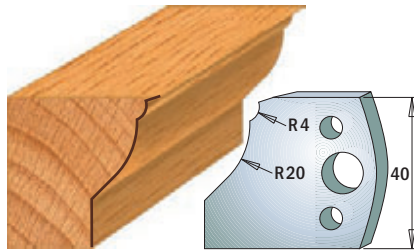

Pair of knives **690.109**
Pair of limiters **691.109**

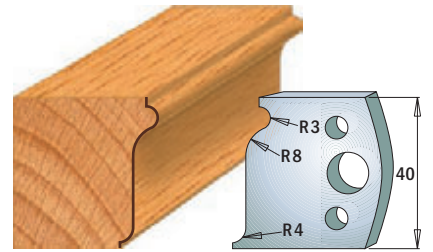

Pair of knives **690.110**
Pair of limiters **691.110**

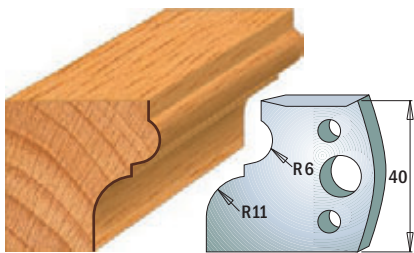

Pair of knives **690.111**
Pair of limiters **691.111**

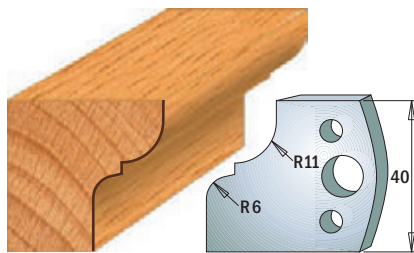

Pair of knives **690.112**
Pair of limiters **691.112**

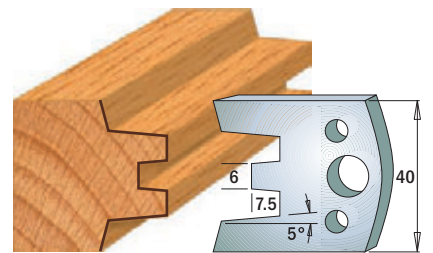

Pair of knives **690.113**
Pair of limiters **691.113**

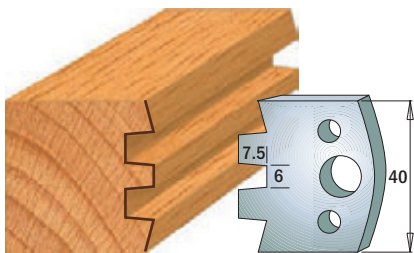

Pair of knives **690.114**
Pair of limiters **691.114**

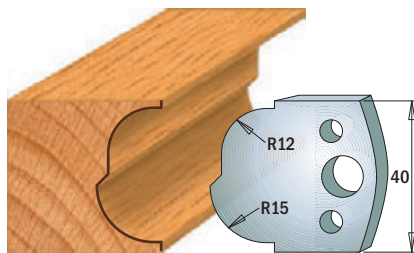

Pair of knives **690.115**
Pair of limiters **691.115**

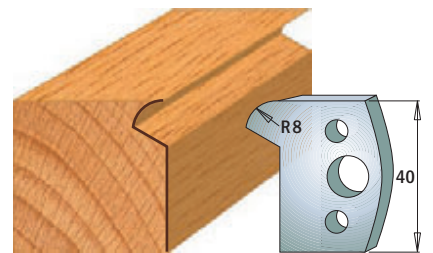

Pair of knives **690.116**
Pair of limiters **691.116**

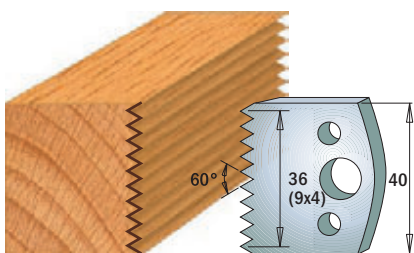

Pair of knives **690.117**
Pair of limiters **691.117**

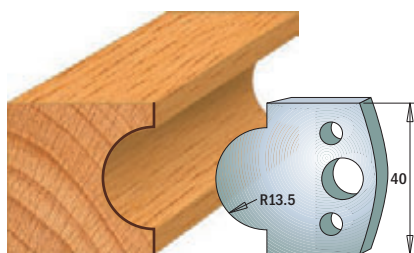

Pair of knives **690.118**
Pair of limiters **691.118**

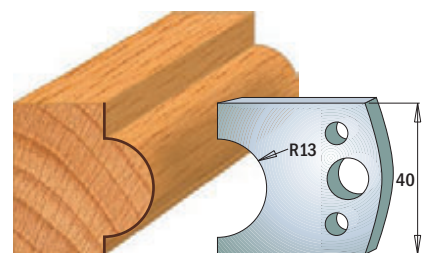

Pair of knives **690.119**
Pair of limiters **691.119**

Note: all knives and limiters only available in pairs

Drawings are 1:2 scale

Dimensions in mm.

Saw blades

Jig saw blades

Tools with bore & Knives

Router bits & sets

CNC router cutter & chucks

Industrial dowel drills

Bits for hand power tools

Power tools & accessories

Display cabinets & spare parts

Profile knives and limiters

Cutting length=40mm Thickness=4mm

SP

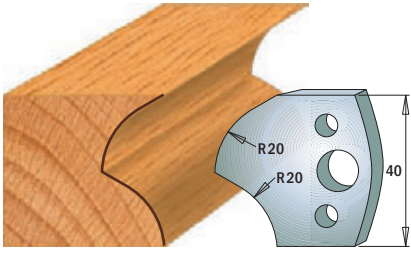

Pair of knives **690.120**
Pair of limiters **691.120**

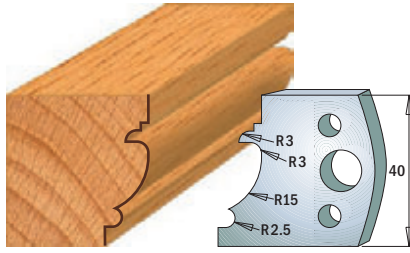

Pair of knives **690.121**
Pair of limiters **691.121**

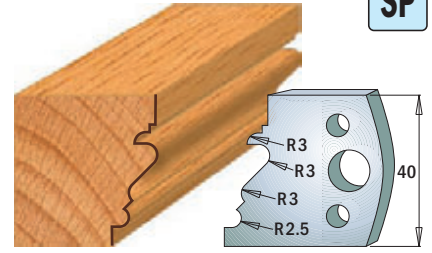

Pair of knives **690.122**
Pair of limiters **691.122**

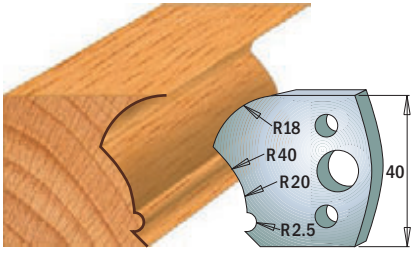

Pair of knives **690.123**
Pair of limiters **691.123**

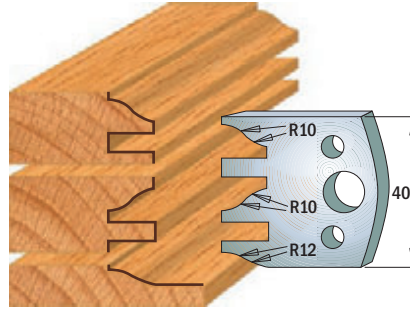

Pair of knives **690.124**
Pair of limiters **691.124**

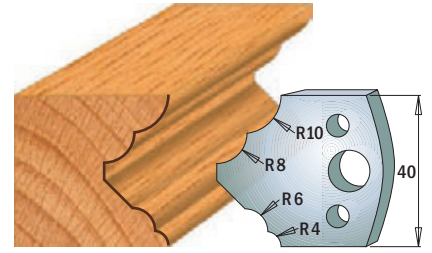

Pair of knives **690.125**
Pair of limiters **691.125**

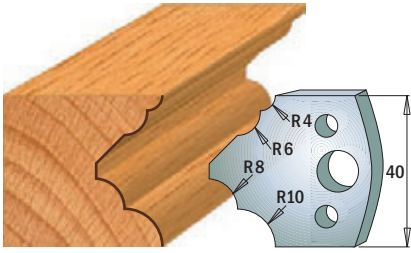

Pair of knives **690.126**
Pair of limiters **691.126**

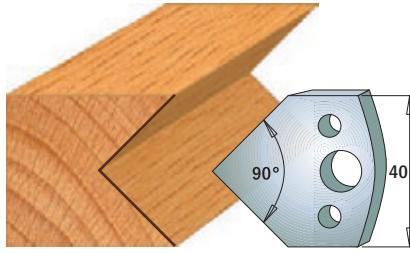

Pair of knives **690.127**
Pair of limiters **691.127**

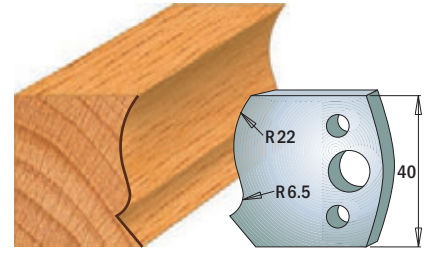

Pair of knives **690.128**
Pair of limiters **691.128**

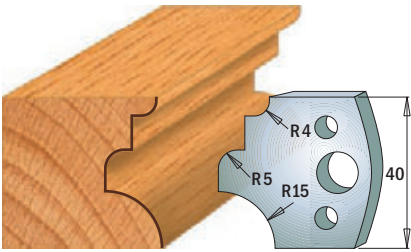

Pair of knives **690.129**
Pair of limiters **691.129**

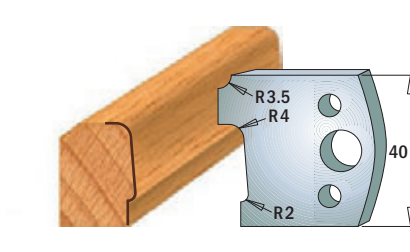

Pair of knives **690.130**
Pair of limiters **691.130**

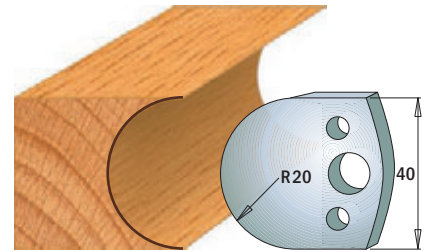

Pair of knives **690.131**
Pair of limiters **691.131**

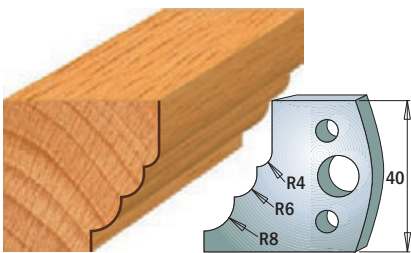

Pair of knives **690.132**
Pair of limiters **691.132**

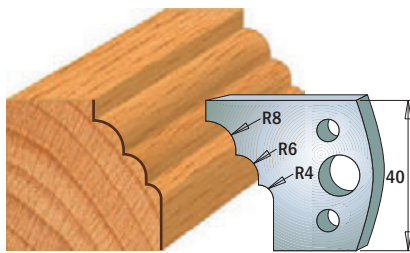

Pair of knives **690.133**
Pair of limiters **691.133**

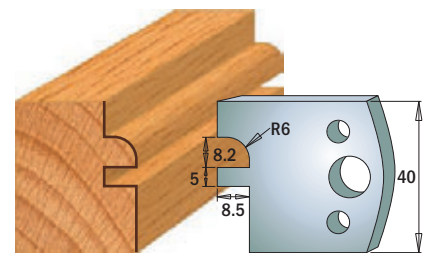

Pair of knives **690.134**
Pair of limiters **691.134**

Note: all knives and limiters only available in pairs

Drawings are 1:2 scale

Dimensions in mm.

Profile knives and limiters

Cutting length=40mm Thickness=4mm

SP

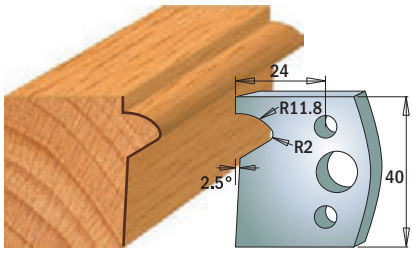

Pair of knives **690.135**
Pair of limiters **691.135**

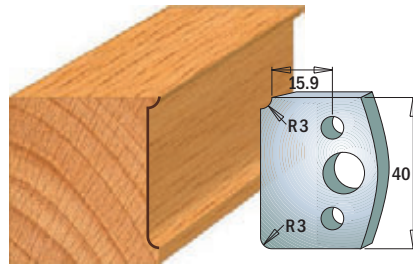

Pair of knives **690.170**
Pair of limiters **691.170**

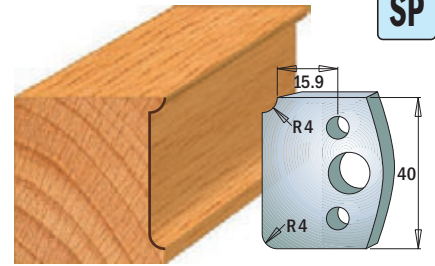

Pair of knives **690.171**
Pair of limiters **691.171**

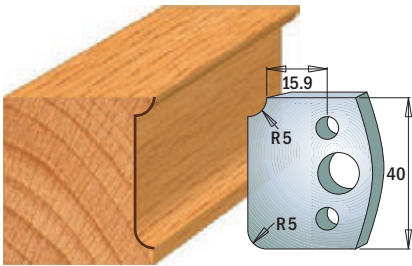

Pair of knives **690.172**
Pair of limiters **691.172**

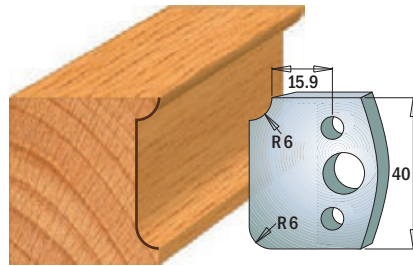

Pair of knives **690.173**
Pair of limiters **691.173**

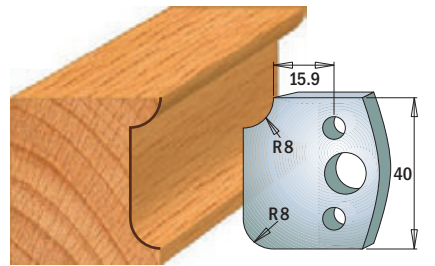

Pair of knives **690.174**
Pair of limiters **691.174**

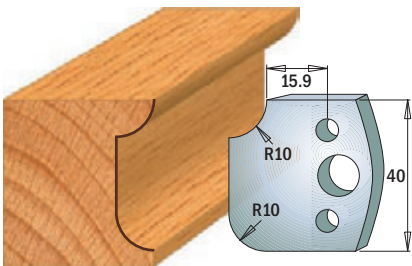

Pair of knives **690.175**
Pair of limiters **691.175**

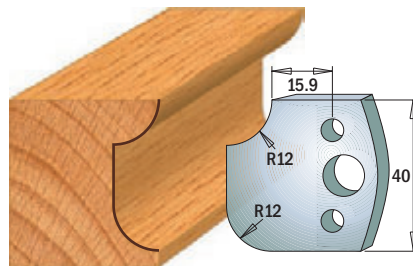

Pair of knives **690.176**
Pair of limiters **691.176**

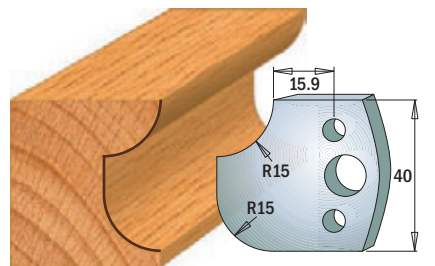

Pair of knives **690.177**
Pair of limiters **691.177**

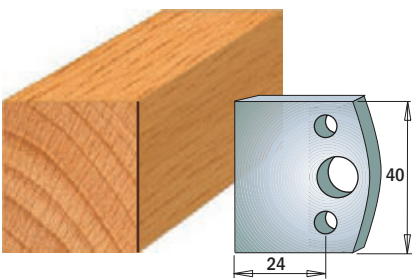

Pair of knives **690.192**
Pair of limiters **691.192**

Profile knives and limiters
Cutting length=50mm Thickness=4mm

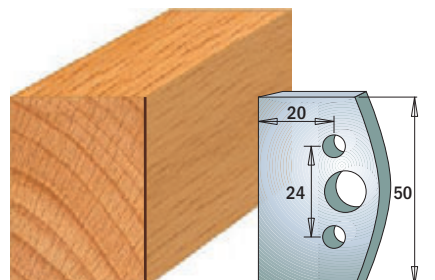

Pair of knives **690.500**
Pair of limiters **691.500**

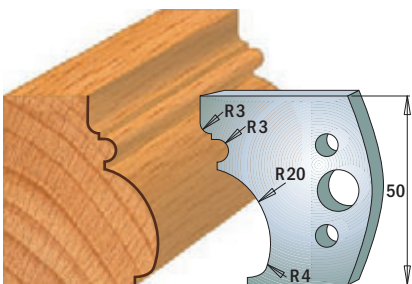

Pair of knives **690.501**
Pair of limiters **691.501**

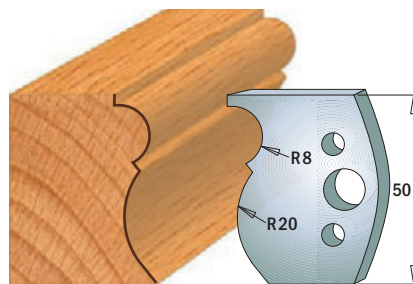

Pair of knives **690.502**
Pair of limiters **691.502**

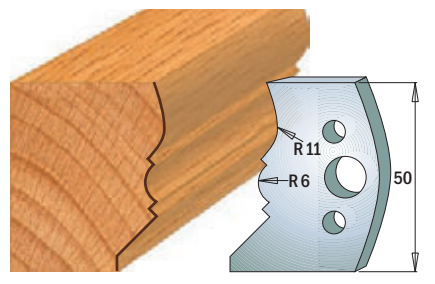

Pair of knives **690.503**
Pair of limiters **691.503**

Note: all knives and limiters only available in pairs

Drawings are 1:2 scale

Dimensions in mm.

Saw blades

Jig saw blades

Tools with bore & Knives

Router bits & sets

CNC router cutter & chucks

Industrial dowel drills

Bits for hand power tools

Power tools & accessories

Display cabinets & spare parts

Profile knives and limiters

Cutting length=50mm Thickness=4mm



SP

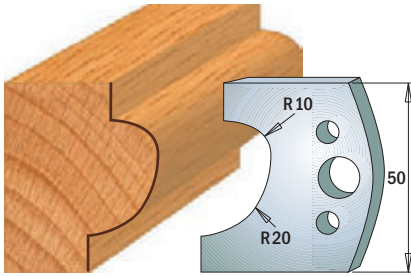

Pair of knives **690.504**
Pair of limiters **691.504**

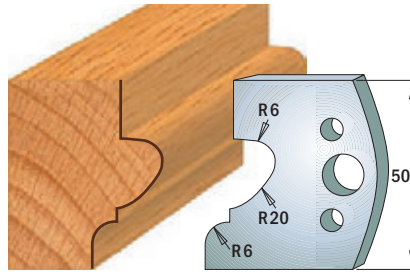

Pair of knives **690.505**
Pair of limiters **691.505**

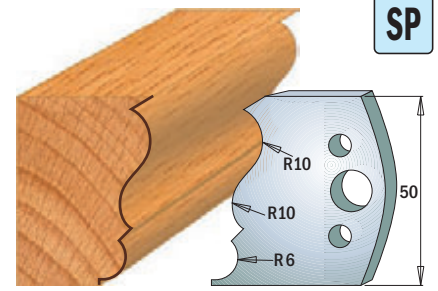

Pair of knives **690.506**
Pair of limiters **691.506**

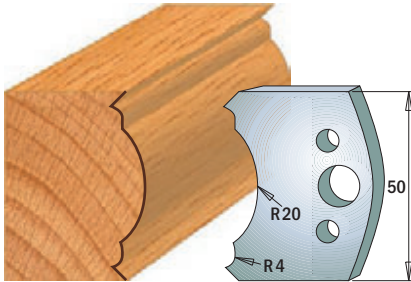

Pair of knives **690.507**
Pair of limiters **691.507**

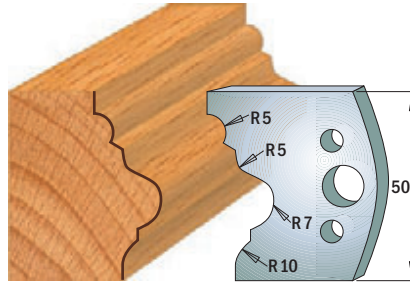

Pair of knives **690.508**
Pair of limiters **691.508**

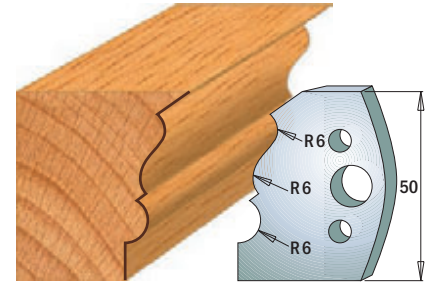

Pair of knives **690.509**
Pair of limiters **691.509**

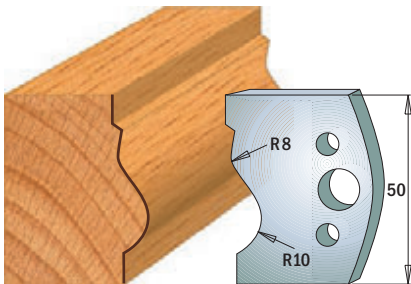

Pair of knives **690.510**
Pair of limiters **691.510**

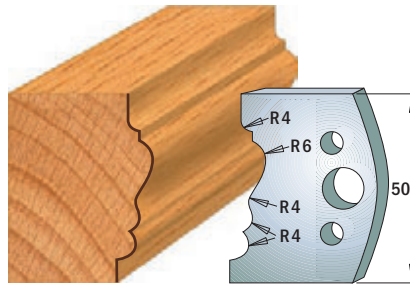

Pair of knives **690.511**
Pair of limiters **691.511**

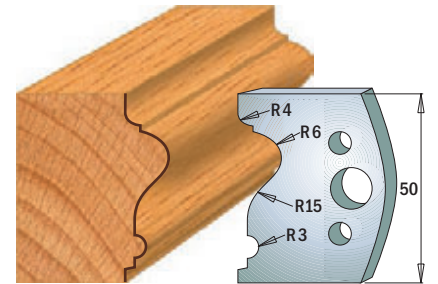

Pair of knives **690.512**
Pair of limiters **691.512**

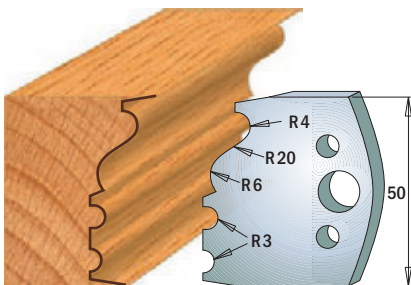

Pair of knives **690.513**
Pair of limiters **691.513**

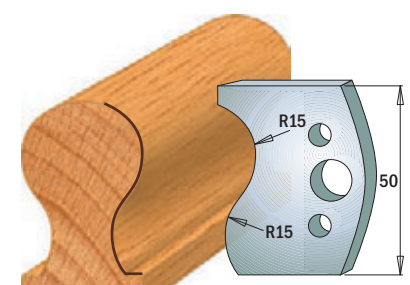

Pair of knives **690.514**
Pair of limiters **691.514**

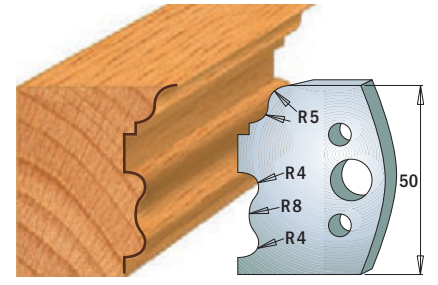

Pair of knives **690.515**
Pair of limiters **691.515**

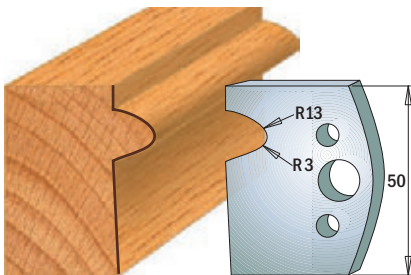

Pair of knives **690.516**
Pair of limiters **691.516**

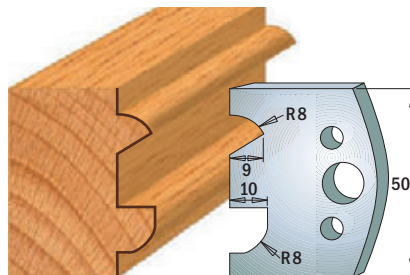

Pair of knives **690.517**
Pair of limiters **691.517**

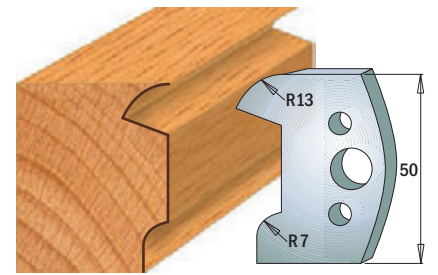

Pair of knives **690.518**
Pair of limiters **691.518**

Note: all knives and limiters only available in pairs

Drawings are 1:2 scale

Dimensions in mm.

Saw blades

Jig saw blades

Tools with bore & Knives

Router bits & sets

CNC router cutter & chucks

Industrial dowel drills

Bits for hand power tools

Power tools & accessories

Display cabinets & spare parts

Profile knives and limiters

Cutting length=50mm Thickness=4mm

SP

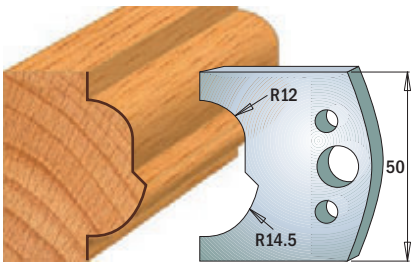

Pair of knives **690.519**
Pair of limiters **691.519**

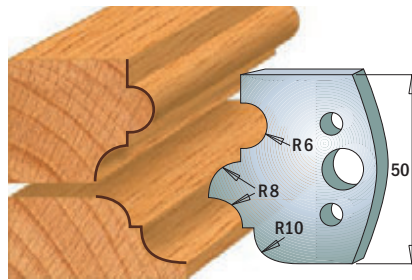

Pair of knives **690.520**
Pair of limiters **691.520**

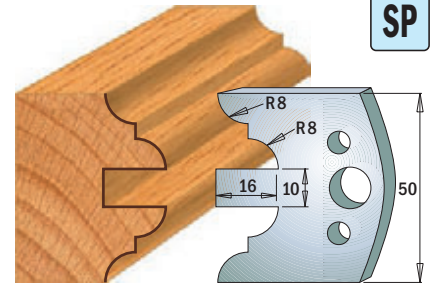

Pair of knives **690.522**
Pair of limiters **691.522**

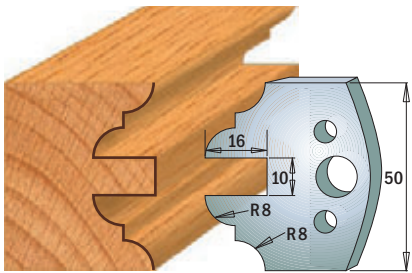

Pair of knives **690.523**
Pair of limiters **691.523**

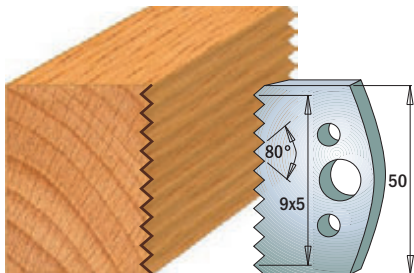

Pair of knives **690.524**
Pair of limiters **691.524**

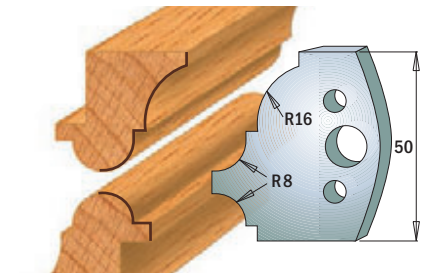

Pair of knives **690.541**
Pair of limiters **691.541**

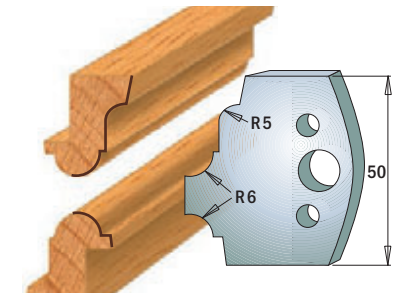

Pair of knives **690.542**
Pair of limiters **691.542**

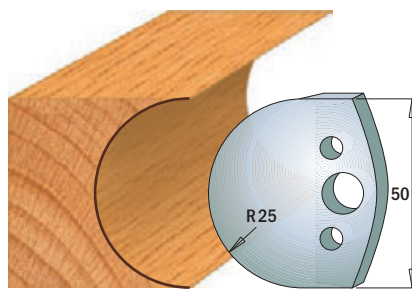

Pair of knives **690.543**
Pair of limiters **691.543**

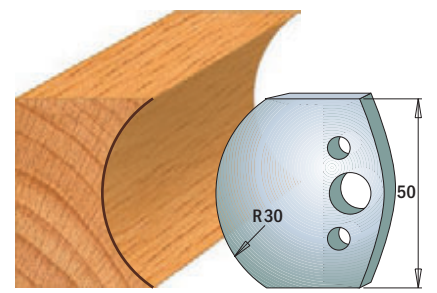

Pair of knives **690.544**
Pair of limiters **691.544**

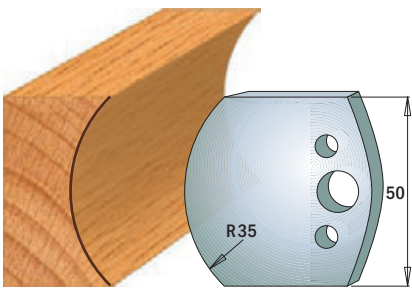

Pair of knives **690.545**
Pair of limiters **691.545**

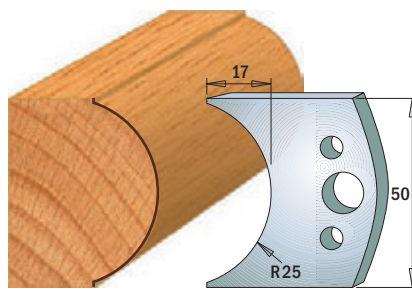

Pair of knives **690.546**
Pair of limiters **691.546**

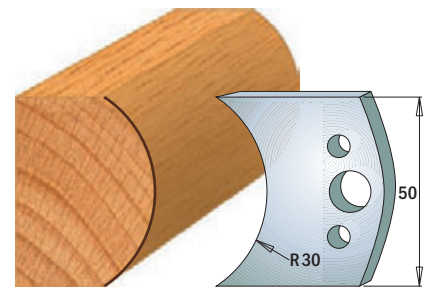

Pair of knives **690.547**
Pair of limiters **691.547**

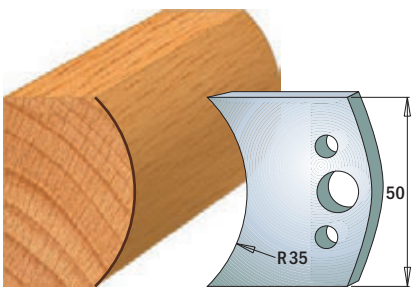

Pair of knives **690.548**
Pair of limiters **691.548**

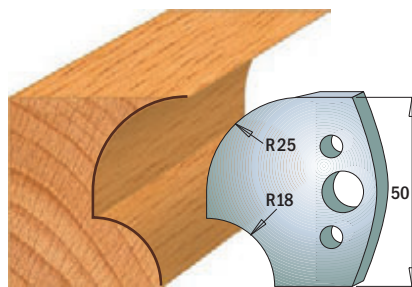

Pair of knives **690.549**
Pair of limiters **691.549**

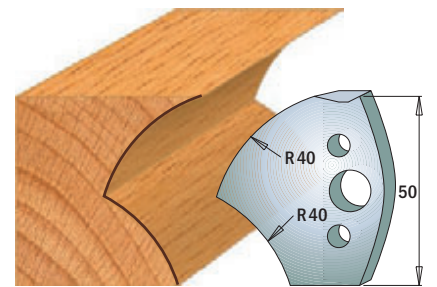

Pair of knives **690.550**
Pair of limiters **691.550**

Note: all knives and limiters only available in pairs

Drawings are 1:2 scale

Dimensions in mm.

Saw blades

Jig saw blades

Tools with bore & Knives

Router bits & sets

CNC router cutter & chucks

Industrial dowel drills

Bits for hand power tools

Power tools & accessories

Display cabinets & spare parts

Profile knives and limiters

Cutting length=50mm Thickness=4mm

SP

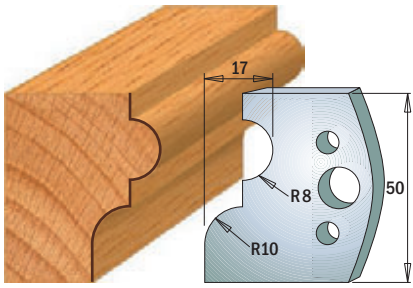

Pair of knives **690.551**
Pair of limiters **691.551**

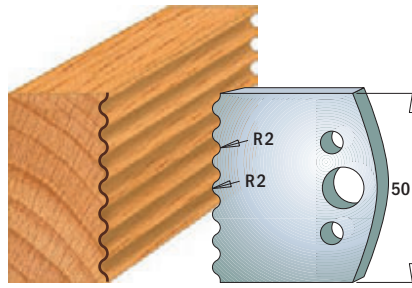

Pair of knives **690.552**
Pair of limiters **691.552**

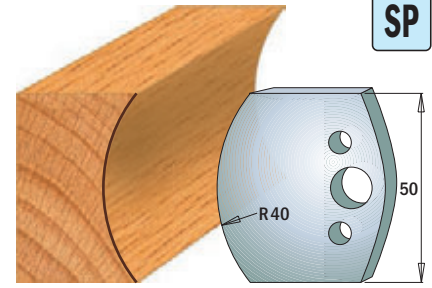

Pair of knives **690.553**
Pair of limiters **691.553**

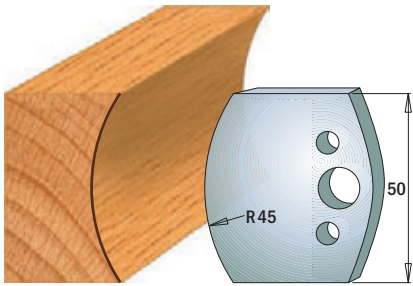

Pair of knives **690.554**
Pair of limiters **691.554**

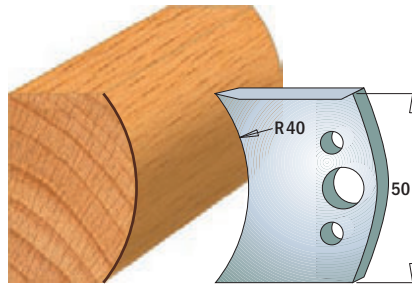

Pair of knives **690.555**
Pair of limiters **691.555**

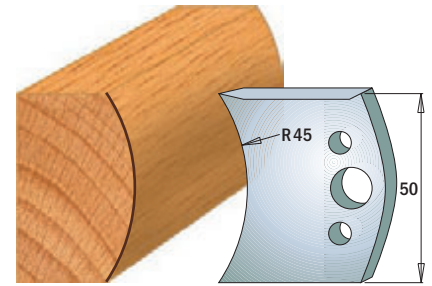

Pair of knives **690.556**
Pair of limiters **691.556**

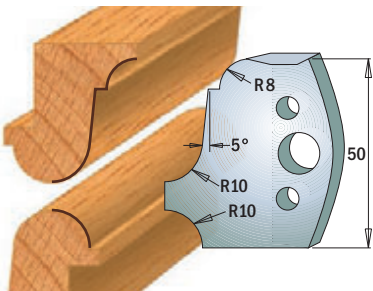

Pair of knives **690.557**
Pair of limiters **691.557**

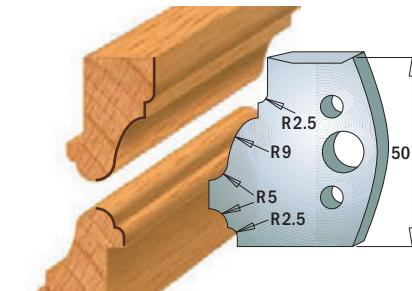

Pair of knives **690.558**
Pair of limiters **691.558**

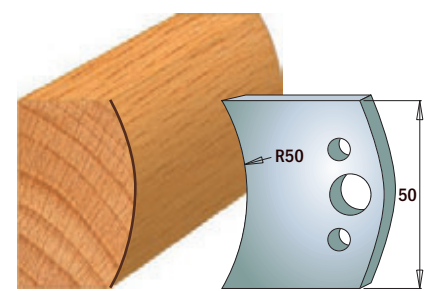

Pair of knives **690.559**
Pair of limiters **691.559**

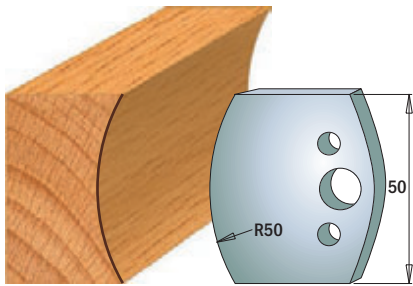

Pair of knives **690.560**
Pair of limiters **691.560**

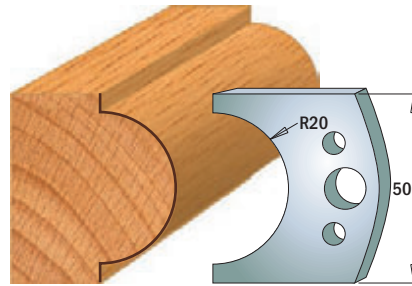

Pair of knives **690.561**
Pair of limiters **691.561**

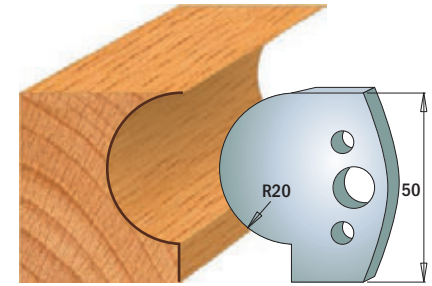

Pair of knives **690.562**
Pair of limiters **691.562**

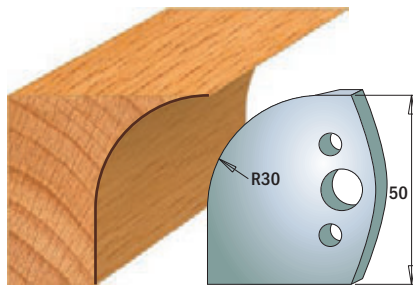

Pair of knives **690.563**
Pair of limiters **691.563**

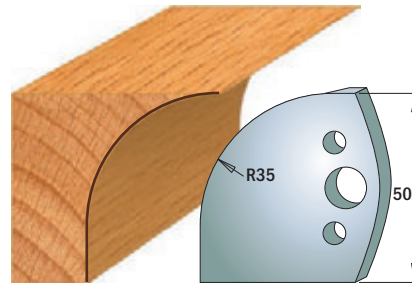

Pair of knives **690.564**
Pair of limiters **691.564**

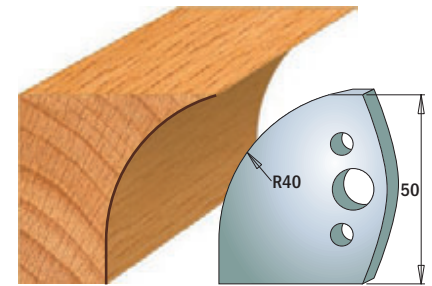

Pair of knives **690.565**
Pair of limiters **691.565**

Note: all knives and limiters only available in pairs

Drawings are 1:2 scale

Dimensions in mm.

Saw blades

Jig saw blades

Tools with bore & Knives

Router bits & sets

CNC router cutter & chucks

Industrial dowel drills

Bits for hand power tools

Power tools & accessories

Display cabinets & spare parts

Profile knives and limiters

Cutting length=50mm Thickness=4mm

Saw blades

Jig saw blades

Tools with bore & Knives

Router bits & sets

CNC router cutter & chucks

Industrial dowel drills

Bits for hand power tools

Power tools & accessories

Display cabinets & spare parts

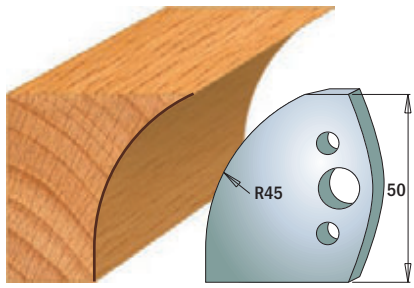

Pair of knives **690.566**
Pair of limiters **691.566**

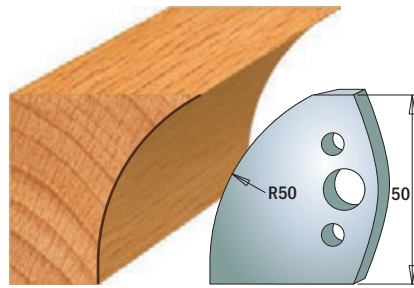

Pair of knives **690.567**
Pair of limiters **691.567**

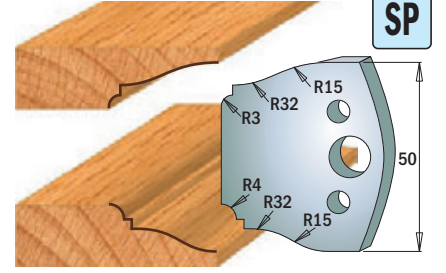

Pair of knives **690.568**
Pair of limiters **691.568**

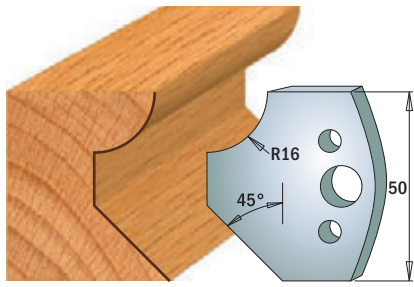

Pair of knives **690.569**
Pair of limiters **691.569**

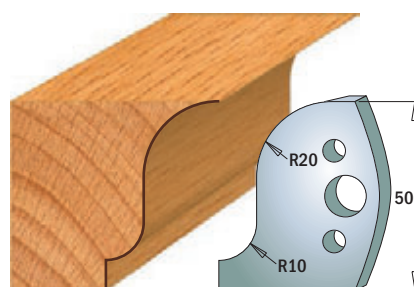

Pair of knives **690.570**
Pair of limiters **691.570**

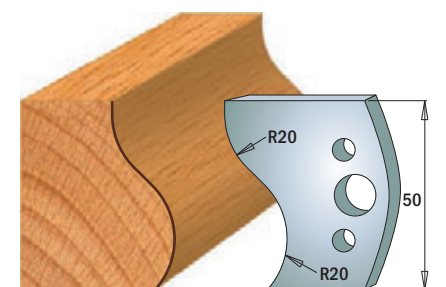

Pair of knives **690.571**
Pair of limiters **691.571**

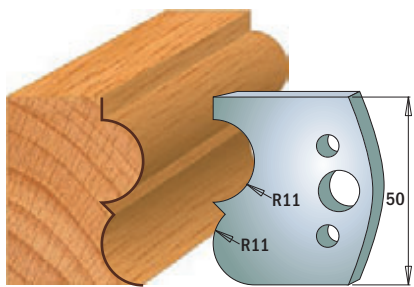

Pair of knives **690.572**
Pair of limiters **691.572**

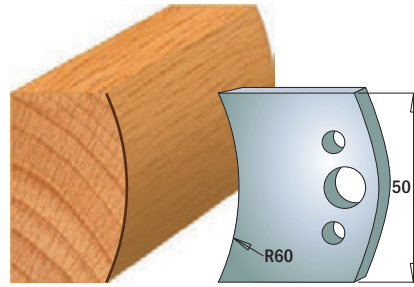

Pair of knives **690.573**
Pair of limiters **691.573**

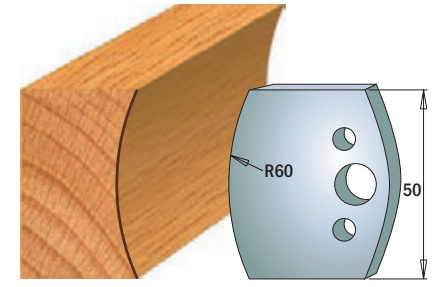

Pair of knives **690.574**
Pair of limiters **691.574**

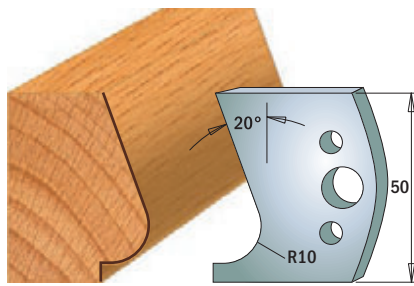

Pair of knives **690.575**
Pair of limiters **691.575**

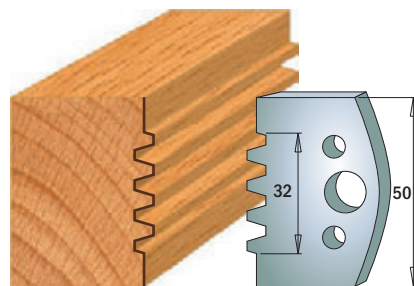

Pair of knives **690.576**
Pair of limiters **691.576**

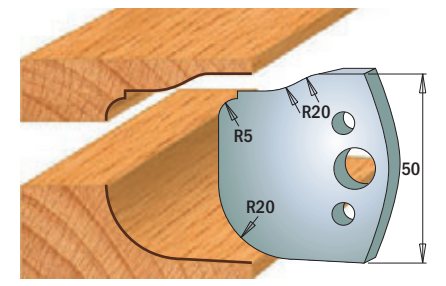

Pair of knives **690.577**
Pair of limiters **691.577**

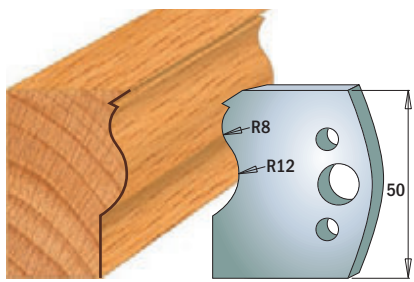

Pair of knives **690.578**
Pair of limiters **691.578**

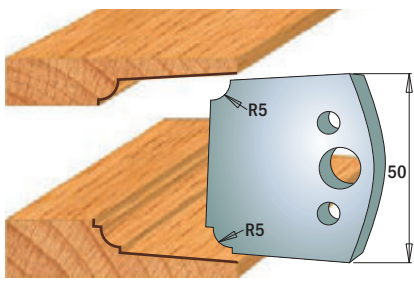

Pair of knives **690.579**
Pair of limiters **691.579**

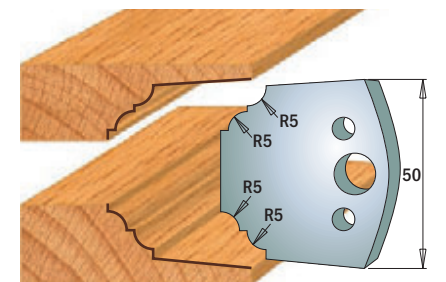

Pair of knives **690.580**
Pair of limiters **691.580**

Note: all knives and limiters only available in pairs

Drawings are 1:2 scale

Dimensions in mm.

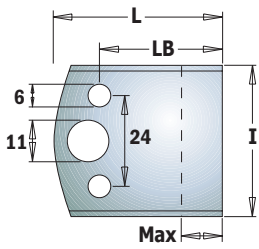

690-691

DESCRIPTION	I mm	LB mm	L mm	Max mm	ORDER NO.
Pair of knives	40	32,5	44,5	18	690.193
Pair of knives	50	34	46	20	690.599
Pair of blank limiters	38	32,5	44,5	18	691.193
Pair of blank limiters	48	34	46	20	691.599

Pair of bore reducers

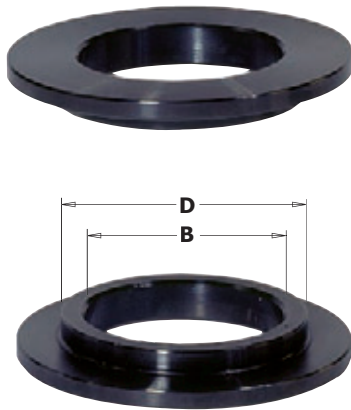

699

D mm	B mm	ORDER NO.	D mm	B mm	ORDER NO.
19,05	12,7	699.019.13	35	31,75	699.035.31
25,4	19,05	699.026.19	40	30	699.040.30
30	19,05	699.030.19	40	32	699.040.32
30	25,4	699.030.26	40	35	699.040.35
31,75	19,05	699.031.19	50	30	699.050.30
31,75	25,4	699.031.26	50	32	699.050.32
31,75	30	699.031.30	50	35	699.050.35
35	30	699.035.30	50	40	699.050.40
35	32	699.035.32			

For use in pair only.

Chucks and "ER20" collets for spindle moulder machine

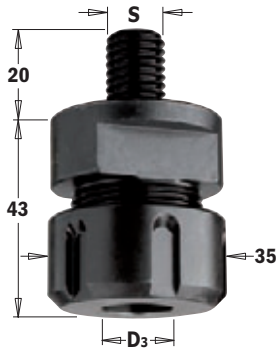

796

S mm	D ₃ mm	L mm	ORDER NO.
M12x1,75	3 ~ 12,7	43	796.122.00
M14x2	3 ~ 12,7	43	796.142.00
M16x2	3 ~ 12,7	43	796.162.00

Spare parts
992.483.03 M25x1,5mm clamping nut
991.483.00 "ER20" key

TECHNICAL DETAILS:
 Super strength steel.
 Precisely machined for accuracy.

Collet not included.

"ER20" precision collets for 796.122/142/162 items

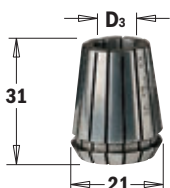

184

D ₃ mm	ORDER NO.	D ₃ mm	ORDER NO.
3	184.030.20	8	184.080.20
5	184.050.20	10	184.100.20
6	184.060.20	12	184.120.20
6,35	184.064.20	12,7	184.127.20

new

HS corrugated back moulder knives

HS

793

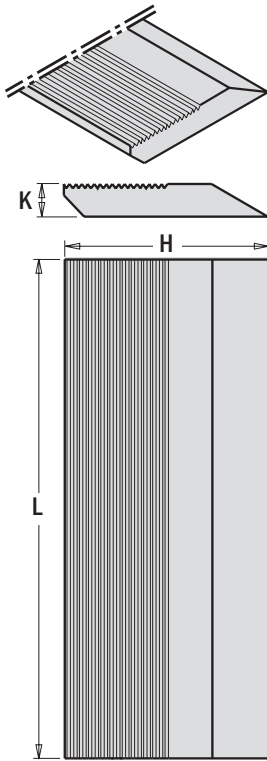

IN QUADROPACK PACKAGING

L mm	H mm	K mm	Knives pieces for each set	ORDER NO. HS 6%W
40 x 50 x 8			4	793.040.50
40 x 60 x 8			4	793.040.60
40 x 70 x 8			4	793.040.70
60 x 50 x 8			4	793.060.50
60 x 60 x 8			4	793.060.60
60 x 70 x 8			4	793.060.70
80 x 50 x 8			4	793.080.50
80 x 60 x 8			4	793.080.60
80 x 70 x 8			4	793.080.70
100 x 50 x 8			4	793.100.50
100 x 60 x 8			4	793.100.60
100 x 70 x 8			4	793.100.70
120 x 50 x 8			4	793.120.50
120 x 60 x 8			4	793.120.60
120 x 70 x 8			4	793.120.70
130 x 60 x 8			4	793.130.60
130 x 70 x 8			4	793.130.70
650 x 40 x 8			4	793.650.40
650 x 50 x 8			4	793.650.50
650 x 60 x 8			4	793.650.60
650 x 70 x 8			4	793.650.70

REMARK: special dimensions available on request.

TECHNICAL DETAILS:

Corrugated back moulder knives for profile cutter heads with precise positioning, angle 60°, pitch 1,6mm.

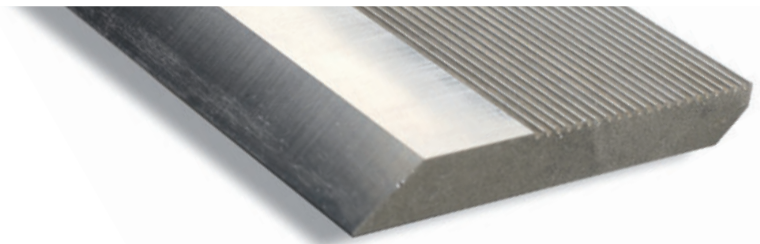

MATERIAL	HS 6% W
Dry softwood	●
Wet softwood	●
Dry hardwood	●
Wet hardwood	○

- Suitable
- Party suitable

Set of 2 magnetic knife setting jigs

CMT792

Insert your knives into your tool holders and align them perfectly with this set! Perfect micro adjustments on your knives will guarantee excellent cutting performance!

1. MAGNETIC STOP
2. JOINTS WITH MAGNETIC CONNECTORS
3. LOCK SCREW



Supplied in a solid wooden box

2 setup possibilities

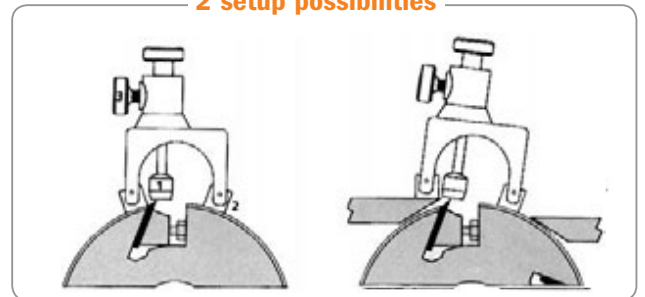

Positioning on the tool holder body with detection of the knife position.

Direct positioning on both the planer table and the tool holder body with detection of the knife position.

Saw blades
Jig saw blades
Tools with bore & Knives
Router bits & sets
CNC router cutter & chucks
Industrial dowel drills
Bits for hand power tools
Power tools & accessories
Display cabinets & spare parts



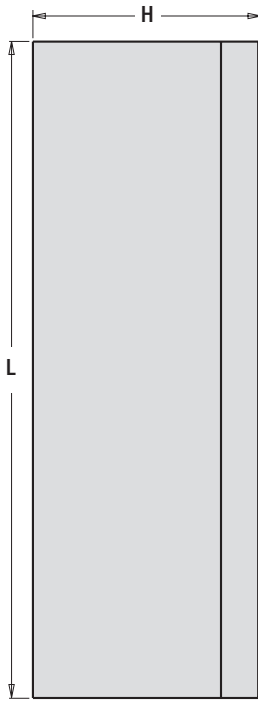
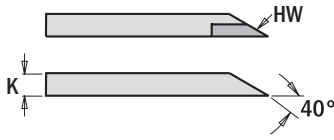
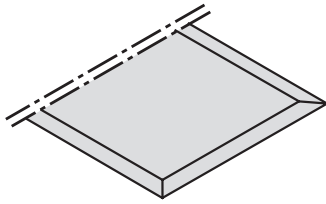

IN QUADROPACK PACKAGING

792



L mm	H mm	K mm	KNIVES pieces for each set	ORDER NO. HS 6%W	ORDER NO. HS 18%W	ORDER NO. HW
120	x 30	x 3	2		792.120.30	
130	x 30	x 3	2	792.131.30	792.130.30	792.132.30
150	x 30	x 3	2		792.150.30	
180	x 30	x 3	2	792.181.30	792.180.30	792.182.30
200	x 30	x 3	2	792.201.30	792.200.30	
210	x 30	x 3	2	792.211.30	792.210.30	
230	x 30	x 3	2	792.231.30	792.230.30	792.232.30
250	x 30	x 3	2	792.251.30	792.250.30	792.252.30
260	x 30	x 3	2	792.261.30	792.260.30	792.262.30
300	x 30	x 3	2	792.301.30	792.300.30	792.302.30
310	x 30	x 3	2	792.311.30	792.310.30	792.312.30
350	x 30	x 3	2	792.351.30	792.350.30	792.352.30
400	x 30	x 3	2	792.401.30	792.400.30	792.402.30
410	x 30	x 3	2	792.411.30	792.410.30	792.412.30
430	x 30	x 3	2	792.431.30	792.430.30	792.432.30
450	x 30	x 3	2	792.451.30	792.450.30	792.452.30
500	x 30	x 3	2	792.501.30	792.500.30	792.502.30
510	x 30	x 3	2	792.511.30	792.510.30	792.512.30
520	x 30	x 3	2	792.521.30	792.520.30	792.522.30
530	x 30	x 3	2	792.531.30	792.530.30	792.532.30
600	x 30	x 3	2	792.601.30	792.600.30	792.602.30
610	x 30	x 3	2	792.611.30	792.610.30	792.612.30
630	x 30	x 3	2	792.631.30	792.630.30	792.632.30
640	x 30	x 3	2		792.640.30	
710	x 30	x 3	2		792.710.30	
810	x 30	x 3	2	792.811.30	792.810.30	792.812.30
1050	x 30	x 3	2	792.998.30	792.997.30	792.999.30
300	x 35	x 3	2		792.300.35	
310	x 35	x 3	2	792.311.35		
350	x 35	x 3	2	792.351.35	792.350.35	
400	x 35	x 3	2	792.401.35	792.400.35	
410	x 35	x 3	2	792.411.35	792.410.35	
430	x 35	x 3	2		792.430.35	
450	x 35	x 3	2	792.451.35	792.450.35	
500	x 35	x 3	2	792.501.35	792.500.35	
510	x 35	x 3	2	792.511.35	792.510.35	
520	x 35	x 3	2	792.521.35	792.520.35	
530	x 35	x 3	2	792.531.35	792.530.35	
550	x 35	x 3	2	792.551.35		
600	x 35	x 3	2	792.601.35	792.600.35	
610	x 35	x 3	2	792.611.35	792.610.35	
630	x 35	x 3	2	792.631.35	792.630.35	
650	x 35	x 3	2	792.651.35		
710	x 35	x 3	2		792.710.35	
810	x 35	x 3	2	792.811.35	792.810.35	
820	x 35	x 3	2	792.821.35		
1050	x 35	x 3	2	792.998.35	792.997.35	

MATERIAL	HS 6%W	HS 18%W	HW
Dry softwood	●	●	
Wet softwood	●	○	
Dry hardwood	○	●	●
Wet hardwood	○	●	○
Chipboard			○
MDF			○
Glulam		○	●
Solid surface			○

- Suitable
- Party suitable

REMARK: special dimensions available on request.

The mirror finish on HW knives produces both razor sharp and extremely durable cutting edges.

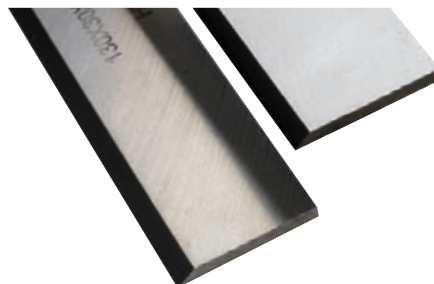

Planer and jointer knives

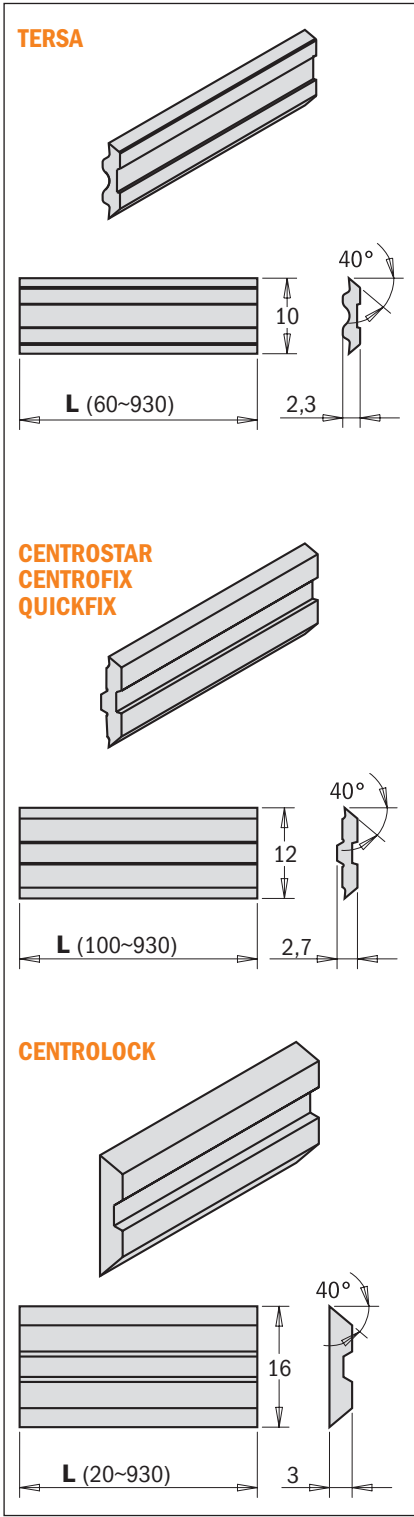

2 KNIVES FOR EACH SET

795

TERSA				CENTROSTAR, CENTROFIX, QUICKFIX				CENTROLOCK			
L	H	K	ORDER NO.	L	H	K	ORDER NO.	L	H	K	ORDER NO.
mm	mm	mm		mm	mm	mm		mm	mm	mm	
60 x 10 x 2,3			795.060.10					20 x 16 x 3			795.020.16
80 x 10 x 2,3			795.080.10					60 x 16 x 3			795.060.16
100 x 10 x 2,3			795.100.10	100 x 12 x 2,7			795.100.12	80 x 16 x 3			795.080.16
110 x 10 x 2,3			795.110.10	110 x 12 x 2,7			795.110.12	100 x 16 x 3			795.100.16
120 x 10 x 2,3			795.120.10	120 x 12 x 2,7			795.120.12				
130 x 10 x 2,3			795.130.10	130 x 12 x 2,7			795.130.12	130 x 16 x 3			795.130.16
				140 x 12 x 2,7			795.140.12				
150 x 10 x 2,3			795.150.10	150 x 12 x 2,7			795.150.12	150 x 16 x 3			795.150.16
				160 x 12 x 2,7			795.160.12				
170 x 10 x 2,3			795.170.10	170 x 12 x 2,7			795.170.12	170 x 16 x 3			795.170.16
180 x 10 x 2,3			795.180.10	180 x 12 x 2,7			795.180.12	180 x 16 x 3			795.180.16
				190 x 12 x 2,7			795.190.12	190 x 16 x 3			795.190.16
				200 x 12 x 2,7			795.200.12				
210 x 10 x 2,3			795.210.10	210 x 12 x 2,7			795.210.12	210 x 16 x 3			795.210.16
				220 x 12 x 2,7			795.220.12				
230 x 10 x 2,3			795.230.10	230 x 12 x 2,7			795.230.12	230 x 16 x 3			795.230.16
								235 x 16 x 3			795.235.16
				240 x 12 x 2,7			795.240.12	240 x 16 x 3			795.240.16
250 x 10 x 2,3			795.250.10	250 x 12 x 2,7			795.250.12				
260 x 10 x 2,3			795.260.10	260 x 12 x 2,7			795.260.12	260 x 16 x 3			795.260.16
				270 x 12 x 2,7			795.270.12	270 x 16 x 3			795.270.16
280 x 10 x 2,3			795.280.10	280 x 12 x 2,7			795.280.12				
300 x 10 x 2,3			795.300.10	300 x 12 x 2,7			795.300.12				
310 x 10 x 2,3			795.310.10	310 x 12 x 2,7			795.310.12	310 x 16 x 3			795.310.16
330 x 10 x 2,3			795.330.10								
350 x 10 x 2,3			795.350.10	350 x 12 x 2,7			795.350.12				
360 x 10 x 2,3			795.360.10	360 x 12 x 2,7			795.360.12				
400 x 10 x 2,3			795.400.10	400 x 12 x 2,7			795.400.12				
410 x 10 x 2,3			795.410.10	410 x 12 x 2,7			795.410.12				
420 x 10 x 2,3			795.420.10	420 x 12 x 2,7			795.420.12				
430 x 10 x 2,3			795.430.10	430 x 12 x 2,7			795.430.12				
450 x 10 x 2,3			795.450.10	450 x 12 x 2,7			795.450.12				
								460 x 16 x 3			795.460.16
				480 x 12 x 2,7			795.480.12				
500 x 10 x 2,3			795.500.10								
510 x 10 x 2,3			795.510.10	510 x 12 x 2,7			795.510.12				
520 x 10 x 2,3			795.520.10	520 x 12 x 2,7			795.520.12				
530 x 10 x 2,3			795.530.10	530 x 12 x 2,7			795.530.12				
540 x 10 x 2,3			795.540.10								
610 x 10 x 2,3			795.610.10	610 x 12 x 2,7			795.610.12				
				620 x 12 x 2,7			795.620.12				
630 x 10 x 2,3			795.630.10	630 x 12 x 2,7			795.630.12				
635 x 10 x 2,3			795.635.10								
640 x 10 x 2,3			795.640.10	640 x 12 x 2,7			795.640.12				
650 x 10 x 2,3			795.650.10	650 x 12 x 2,7			795.650.12	650 x 16 x 3			795.650.16
710 x 10 x 2,3			795.710.10	710 x 12 x 2,7			795.710.12				
				810 x 12 x 2,7			795.810.12				
860 x 10 x 2,3			795.860.10								
910 x 10 x 2,3			795.910.10								
930 x 10 x 2,3			795.930.10	930 x 12 x 2,7			795.930.12	930 x 16 x 3			795.930.16

REMARK: special dimensions available on request.

TECHNICAL DETAILS:

HPS® is especially developed for the woodworking industry. Through the cooperation with the Thyssen-Krupp heat treatment division developed special heat treatment in modern high vacuum oven gets this steel its special attributes which makes it to a real alternative to the HSS steels. The main advantages are:

- superb wear resistance
- maximum level of toughness
- resistance to softening
- easy to profile
- long lasting tested

A test result: Wood=Oak, Spinadle speed=6000 rpm, feed=24 meter/min
 = Result HPS® 17500 meters.
 = Result HSS 10000 meters.

MATERIAL	GOOD	EXCELLENT
Dry Softwood		●
Wet Softwood		●
Dry Hardwood		●
Wet Hardwood		●
Exotic Hardwood	●	

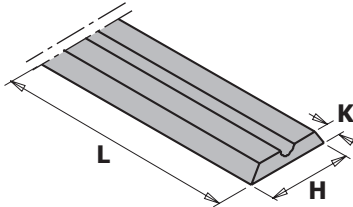

10-PCS. CASE

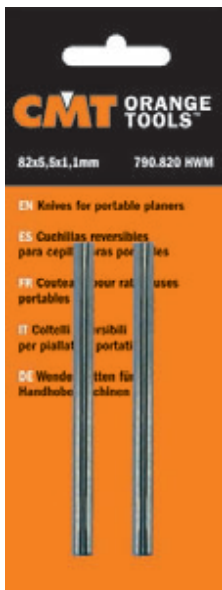

2-PCS. BLISTER CASE
(790.780/790.805/790.820)

790

L mm	H mm	K mm	MACHINE	MODEL MACHINE	ORDER NO. 2 pcs. blister case	ORDER NO. 10 pcs. blister case
56,0 x 5,5 x 1,1			Adler			790.560.00
60,0 x 5,5 x 1,1			Wegoma			790.600.01
75,5 x 5,5 x 1,1			Aeg	HTH75	new 790.755	790.755.00
			Black & Decker	DN75, 750SR, 600K		
			Bosch	0590, P400, 1590,1591		
			Festo	REP75		
			Haffner	FH222		
			Holz-Her	2223, 2286, 2320		
			Kress	Jet-Star 6701, 6702		
			Mafell	HU75		
			Metabo	6375		
			Scheer	MH75/3, MH80		
			Skil	98H		
78,0 x 5,5 x 1,1			Virutex		790.780	790.780.00
80,5 x 5,9 x 1,2			Elu	MFF40, MFF80, MFF81, MFF81EK, PF161	new 790.806	790.805.00
80,5 x 5,5 x 1,1			Elu	MFF80	790.805	790.805.01
			Aeg			
			Bosch			
			Haffner			
82,0 x 5,5 x 1,1			Aeg	EH82, EH825, EH822, EH450, EH700, EH82-1, H500, H750, EH700R	790.820	790.820.00
			Black & Decker	DN76		
			Bosch	PHO 100/150, PHO 200/300 4387, PHO 2-82/3-82, Gustav, H00882		
			Casals	CE82		
			DeWalt	DW678, DW678EK, DW680		
			Elu	HH15, HH40, HH40K, HH40EK		
			Fein	HS2151		
			Felisatti	TP282		
			Haffner	FH224		
			Hitachi	F20, F20A, FP20A, P20V, P20SA		
			Holz-Her	2321, 2322		
			Legna	R82, G82		
			Mafell	EHU82, MHU82		
			Makita	1001, 1100, 1125B, 1900B, 1901, 1923B, 1923H, 1923HO		
			Metabo	4382, 8382, 0882, 0883, E0983		
			Perless	HHB82B		
			Peugeot	RA400, 82RAC, RA82CS, BR82 BRA1-82, BRA3-82, RA1082CA		
			Ryobi	L1323-A		
			Skil	H92, H94, H95, H96, H97 1506, 1510		
			Stayer	980B		
92,0 x 5,5 x 1,2			Aeg	450		790.920.00
			Hitachi	F30A, FU30		
			Ryobi	L120N, L150N, L1205N, L1323		
102,0 x 5,5 x 1,1			Aeg	HB750, EH102, HBE800		790.992.00

TECHNICAL DETAILS:

- Order no. ISO: K40
- Hardness (HV10): 1.400
- Transverse rupture strength (N/mm²): 2.600

APPLICATION:

- Soft wood Good
- Hard wood Suitable
- Plywood Suitable



HWM reversible knives

Saw blades

Jig saw blades

Tools with bore & Knives

Router bits & sets

CNC router cutter & chucks

Industrial dowel drills

Bits for hand power tools

Power tools & accessories

Display cabinets & spare parts

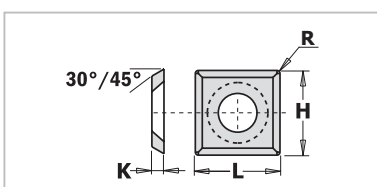
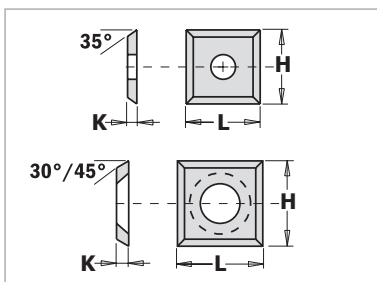
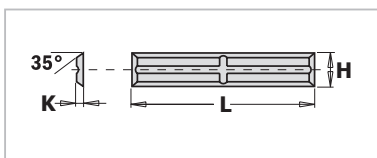
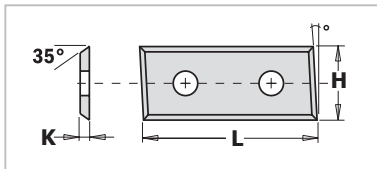
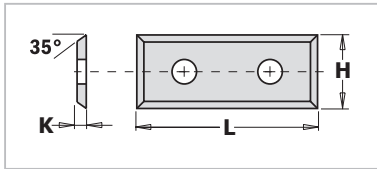
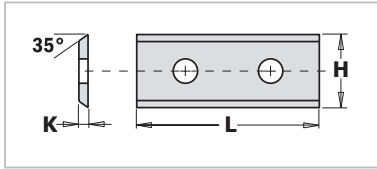
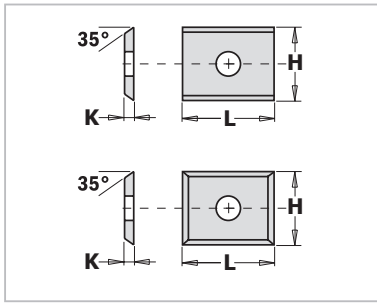

790 Standard reversible knives 2 cutting edges

L mm	H mm	K mm	A	F1730	S2020	U2300	N2550
7,5 x 12 x 1,5			35°	790.075.00			
7,65 x 12 x 1,5			35°	790.076.00			
9,6 x 12 x 1,5			35°	790.096.00			
15 x 12 x 1,5			35°	790.150.00			
new 19,5 x 12 x 1,5			4/35°	790.195.12			
20 x 12 x 1,5			35°	790.200.00	790.200.02	790.200.03	

790 Standard reversible knives 2 cutting edges

L mm	H mm	K mm	A	F1730	S2020	U2300	N2550
24,7 x 12 x 1,5			35°	790.250.00			
30 x 12 x 1,5			35°	790.300.00	790.300.02	790.300.03	790.300.04
30 x 12 x 1,5			45°		790.300.20		
40 x 12 x 1,5			35°	790.400.00	790.400.02	790.400.03	
50 x 12 x 1,5			35°	790.500.00	790.500.02	790.500.03	790.500.04
60 x 12 x 1,5			35°	790.600.00		790.600.03	

790 Standard reversible knives 4 cutting edges

L mm	H mm	K mm	A	F1730	S2020	U2300	N2550
29,5 x 9 x 1,5			35°	790.295.09			
29,5 x 12 x 1,5			35°	790.295.12			
new 39,5 x 9 x 1,5			35°	790.395.09			
new 39,5 x 12 x 1,5			35°	790.395.12			
49,5 x 9 x 1,5			35°	790.495.09			
49,5 x 12 x 1,5			35°	790.495.12			

790 Standard reversible knives 4 cutting edges

L mm	H mm	K mm	A	F1730	S2020	U2300	N2550
28,3 x 12 x 1,5			35°	790.283.12			
48,3 x 12 x 1,5			35°	790.483.12			

790 Standard reversible knives 4 cutting edges

L mm	H mm	K mm	A	F1730	S2020	U2300	N2550
20 x 4,1 x 1,1			35°	790.200.01			
30 x 5,5 x 1,1			35°	790.300.01			
50 x 5,5 x 1,1			35°	790.500.01			

790 Standard reversible knives 4 cutting edges

L mm	H mm	K mm	A	F1730	S2020	U2300	N2550
12 x 12 x 1,5			35°	790.120.00	790.120.02	790.120.03	
new 13,6 x 13,6 x 2			30°	790.136.00			
14 x 14 x 1,2			30°	790.140.10			
14 x 14 x 2			30°	790.140.00		790.140.03	
14 x 14 x 2			45°		790.140.02		

790 Standard reversible knives 4 cutting edges

L mm	H mm	K mm	A	F1730	S2020	U2300	N2550
new 14 x 14 x 2			R/30°	790.140.20			

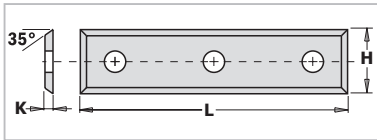

790 Standard reversible knives 4 cutting edges



L mm	H mm	K mm	A	ORDER NO.			
50	9	1,5	35°	F1730	S2020	U2300	N2550
				790.500.09			

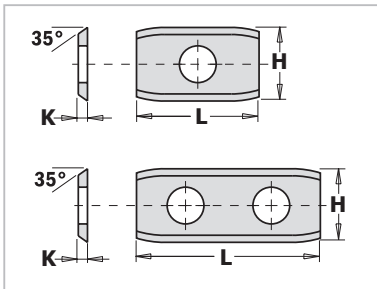

790 Standard reversible knives 2 cutting edges

L mm	H mm	K mm	A	ORDER NO.			
20	12	1,5	35°	F1730	S2020	U2300	N2550
30	12	1,5	35°	790.201.00			
50	12	1,5	35°	790.301.00			
				790.501.00			

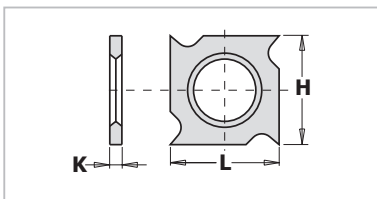

790 Standard reversible knives 4 cutting edges

L mm	H mm	K mm	A	ORDER NO.			
18	18	1,95		F1730	S2020	U2300	N2550
				790.181.00			
18	18	2,45		790.182.00			

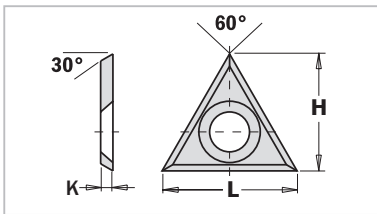

790 Standard reversible knives 30°

L mm	H mm	K mm	A	ORDER NO.			
22	19	2	30°	F1730	S2020	U2300	N2550
				790.220.02			

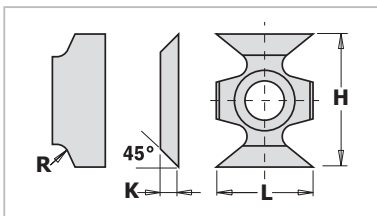

790 Edge rounding/chamfering reversible knives

L mm	H mm	K mm	R mm	A	ORDER NO.			
16	22	5	1,5		F1730	S2020	U2300	N2550
				790.161.00				
16	22	5	2		790.162.00			
16	22	5	3		790.163.00			
16	22	5		45°	790.160.00			

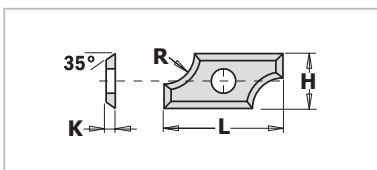

790 Profiled rounding reversible knives 4 cutting edges

L mm	H mm	K mm	R mm	A	ORDER NO.			
19,5	9	1,5	2	35°	F1730	S2020	U2300	N2550
				790.020.00				
19,5	9	1,5	3	35°	790.030.00			
19,5	9	1,5	5	35°	790.050.00			
24	12	1,5	6,4	35°	790.064.00			
24	12	1,5	8	35°	790.080.00			

MATERIAL	F1730	S2020	U2300	N2550
Dry softwood	●			
Wet softwood	●			
Dry hardwood	●	●		
Wet hardwood	●	●		
Chipboard		●	●	●
MDF		●	●	●
HDF			●	●
Solid surface				●

● Suitable

TECHNICAL DETAILS:

F1730 Hardness (HV10): 1.760 - Transverse rupture strength (N/mm²): 2.100

S2020 Hardness (HV10): 1.680 - Transverse rupture strength (N/mm²): 3.700

U2300 Hardness (HV10): 2.300 - Transverse rupture strength (N/mm²): 3.500

N2550 Hardness (HV10): 2.550 - Transverse rupture strength (N/mm²): 3.200

All knives are supplied in 10 pcs. cases.



WHAT'S THE SECRET TO FLAWLESS EDGE PROFILES WITH NO REWORK?

WOOD 
Magazine

CMT The Perfect 10!
Rated the #1 Overall Router Bits



SUPERIOR HIGH-STRENGTH STEEL

We use high-quality, solid bar stock sourced from Switzerland, which provides exceptional resistance to fatigue and abrasion.

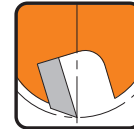

ANTI-KICKBACK DESIGN

Controls depth of cut and minimizes the chance of kickback, reducing your risk of injury.

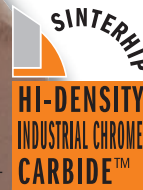

SINTERHIP HI-DENSITY INDUSTRIAL CHROME CARBIDE™

New process called SinterHIP (Hot Isostatic Pressing), helps prevent material failure and increases cutting life.

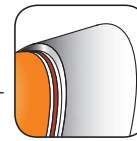

TRI-METAL BRAZING

Our Silver-Copper-Silver brazing protects the carbide tip when cutting harder wood or wood composites and reduces the chance of failed welds.



NON-STICK ORANGE SHIELD COATING™

Prevents bit from heating up, reduces pitch build-up, protects against corrosion and provides a longer bit life.



MULTI-AXIS GRINDING CREATES A 3X LONGER LASTING MIRROR FINISH

Each cutting edge is precisely sharpened to the micron, in order to produce a cutting angle, which is razor sharp, yet extremely durable.



Deluxe packaging



Router bits & sets

PRODUCTS	PAGE
Straight & spiral bits	98 ~ 109
Trimmer & profiler bits	110 ~ 119
Rebater bits	120 ~ 122
Slotting & grooving bits	123 ~ 127
Jointing bits	128 ~ 135
Dovetail bits	136 ~ 138
Lettering, "V" Groove & chamfer bits	139 ~ 144
Drawer pull & radius bits	145 ~ 147
Ovolo & rounding over bits	148 ~ 150
Bead & ogee bits	151 ~ 159
Molding bits	160 ~ 164
Panel bits	164 ~ 170
Solid surface bits	171 ~ 176
Router bit sets	177 ~ 188

BUILDING THE WORLD'S FINEST CUTTING TOOLS

We built our foundations - and our reputation for high quality - on the craftsman-like manufacture of boring bits and router bits. Times have changed and technology has completely altered the way things are done, and in this regard CMT is no exception. Our facilities have been newly renovated and our equipment today represents the most advanced technology available on the market, but we still make and will continue to make routers and boring bits with all the skill and care that we always have.

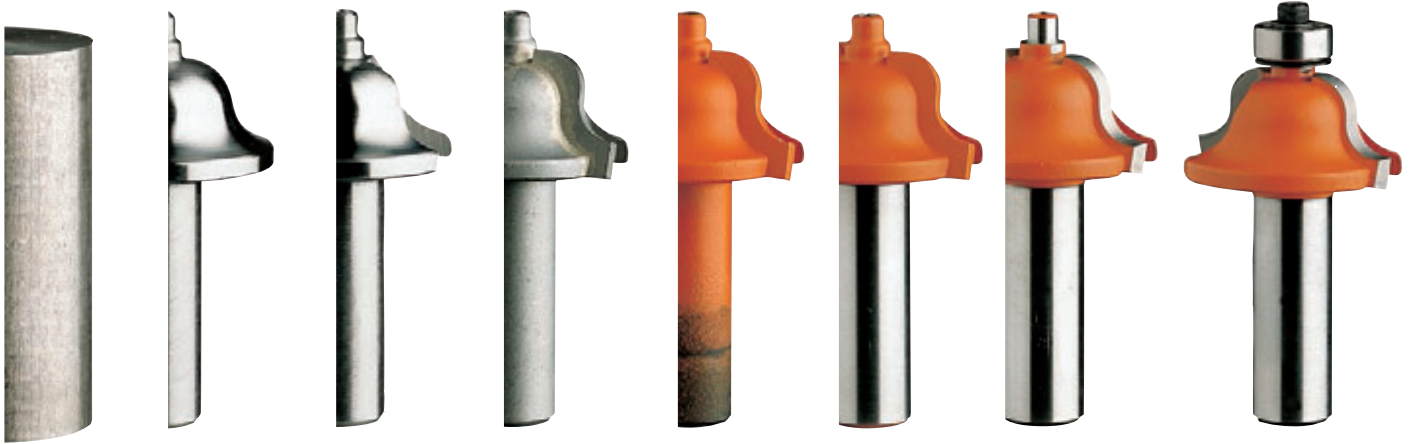

DESIGN

We engineer each tool with its purpose in mind. Years of developing high performance tools means that many of our top-selling tools are tried and true, the result of continuously perfecting each design, but we don't stop there. New materials, new profiles and new methods of working keep emerging. At CMT, we want to stay on the cutting edge of what's new in the industry so our technical department constantly evaluates current market developments and, by using state of the art software and years of experience, designs tools that are worthy of the CMT mark.

MATERIALS

Essentially, the main components of a router bit are just two: steel and carbide. If either of these is less than the best, the tool we make will show it. We've researched steel and carbide since the beginning, and found exactly what we were looking for:

Superior steel. All our steel comes from right above the border, in Switzerland, where they use an exclusive hot drawing process to forge the solid bar stock we use to manufacture our router bit shanks and bodies. The result is steel that is superior in strength and exceptionally resistant to fatigue and abrasion.

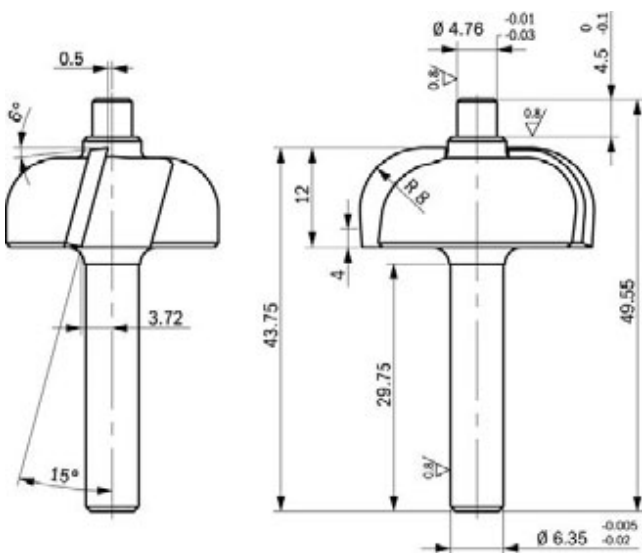

Saw blades
Jig saw blades
Tools with bore & Knives
Router bits & sets
CNC router cutter & chucks
Industrial dowel drills
Bits for hand power tools
Power tools & accessories
Display cabinets & spare parts

High-grade tungsten carbide. If steel is what gives our tools strength, carbide is what gives them intelligence. The capacity of the carbide tip to cut precisely and to last a long time is critical for the performance of any tool, so at CMT we use only premium micrograin carbide from Luxembourg to make the tips for our router bits.

MANUFACTURING

Turning, Milling and Cutting. Our biggest investment in recent years has been in upgrading production. Today, all machinery at CMT is fully automated. CNC machines run by specially trained operators make sure that the shanks and bodies of our router bits and boring bits are accurate and perfectly balanced.

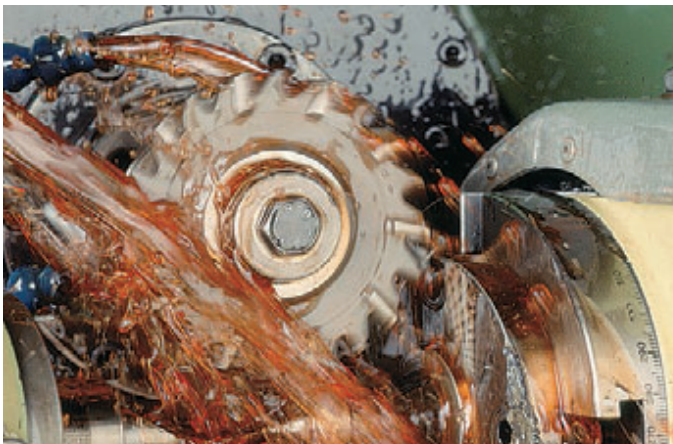

Heat forged steel bodies for large diameter bits. No router bits are exactly the same, sometimes not even in the way they are made. Certain bits require a few more steps than others, like heat forging the steel of larger diameter bits before turning it down into precise bit bodies. This extra step produces a radial grain orientation which gives large diameter bits extra strength and durability.

Brazing. We have pioneered the art of brazing. Not only does our unique custom-designed computerized brazing equipment help eliminate the inconsistencies found in old fashioned hand brazing, but our silver-copper-silver brazing 'sandwich' provides a tight bond between the steel and the carbide, with a shock absorbing effect to protect the carbide tips when cutting harder woods.

Specially formulated carbide for specific applications. You have to cut every kind material, so we make sure that our carbide tips can handle each individual job. This means specially formulating the carbide of each tool so that the compositions vary from being super hard (for tough cutting jobs like laminates) to being less hard (to absorb the impact when cutting large profiles) and everything in between.

Grinding and Sharpening. The final step in the production process is no different from the rest: sharpening and grinding are done to extreme precision on multi-axis CNC machines. Each bevel and angle is ground or sharpened to the micron, to produce a cutting edge that is both razor sharp yet extremely durable.



680°C in seconds - and the brazing is complete.

QUALITY CONTROL

In even the most carefully done task, there's always room for error. However at CMT, we take measures to prevent even this. Just like we have always done, we manually check the quality of our tools at each step of the manufacturing process, and we still make test cuts with rail & stile bits to make sure the cut fits. However, now we also use a fully automatic measuring process that measures every dimension of the tool without actually coming into contact with it, to make sure that the tool measurements are accurate and that the profiles conform precisely to technical specifications. We also use this system to gauge the wear and tear on the CNC machines.



CMT's fully automatic measuring system.

Solid carbide spiral bits

Due to their spiral cutting edge which stays in continuous contact with the workpiece, these bits give a smooth, chatter-free cutting action, unlike conventional bits which have intermittent contact with the workpiece. Unsurpassed for cleaner cuts in ordinary or difficult materials, softwood, hardwood, plywood, composites etc. This new range of spiral bits with 6, 8, 12mm and 6,35 and 12,7mm shanks allow them to be used with C.N.C. router and hand-routers.

Test check yourself the extraordinary quality-price ratio of these bits!

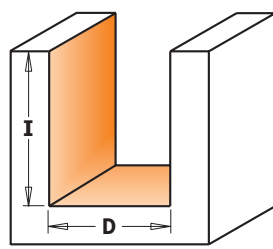

Drawing is 1:1 scale

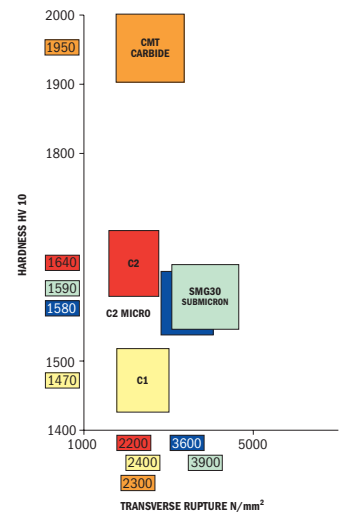

HWM Z2+2 Z3+3 RH

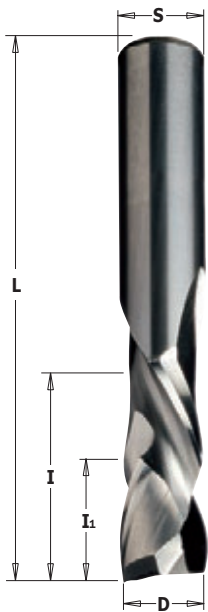

190 Upcut & downcut spiral

D mm	I mm	I ₁ mm	L mm	Z	ORDER NO. S=Ø8mm	ORDER NO. S=Ø9,52mm	ORDER NO. S=Ø10mm	ORDER NO. S=Ø12mm	ORDER NO. S=Ø12,7mm
8	32	7	80	2+2	190.080.11				
9,52	28,6	7	76,2	2+2		190.504.11			
10	32	7	80	2+2			190.100.11		
new 10	42	7	90	2+2			190.101.11		
12	42	7	90	2+2				190.120.11	
new 12	52	7	100	2+2				190.121.11	
12,7	25,4	16	76,2	2+2					190.505.11
12,7	28,6	16	76,2	2+2					190.506.11
12,7	34,9	16	88,9	2+2					190.507.11
12,7	41,3	16	101,6	2+2					190.508.11
<i>Up & downcut mortising bits</i>									
9,52	22,2	4,8	76,2	2+2		190.513.11			
9,52	25,4	5,2	76,2	3+3		190.813.11			
12	25,4	5,2	83	3+3				190.320.11	
12,7	22,2	5,2	76,2	2+2					190.515.11
12,7	34,9	5,2	88,9	2+2					190.517.11

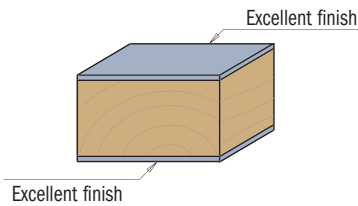

HWM Z1 RH

198 Upcut

D mm	I mm	L mm	ORDER NO. S=Ø6mm	ORDER NO. S=Ø6,35mm	ORDER NO. S=Ø8mm	ORDER NO. S=Ø12mm	ORDER NO. S=Ø12,7mm
3,18	12,7	50,8		198.001.11			
4,76	15,87	50,8		198.005.11			
6	22	60	198.060.11				
6,35	19,05	50,8		198.007.11			
6,35	25,4	63,5		198.008.11			
8	22	70			198.080.11		
new 8	32	80			198.081.11		
12	32	83				198.120.11	

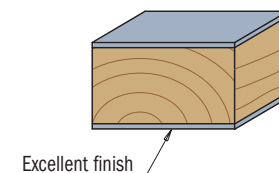

Saw blades
Jig saw blades
Tools with bore & Knives
Router bits & sets
CNC router cutter & chucks
Industrial dowel drills
Bits for hand power tools
Power tools & accessories
Display cabinets & spare parts



191 Upcut spiral

HWM Z2 RH

D mm	I mm	L mm	ORDER NO. S=Ø6mm	ORDER NO. S=Ø6,35mm	ORDER NO. S=Ø8mm	ORDER NO. S=Ø12mm	ORDER NO. S=Ø12,7mm
3	12	60	191.630.11		191.830.11		
3,18	12,7	50,8		191.001.11			
3,5	12	60	191.635.11				
3,97	12,7	50,8		191.003.11			
4	15	60	191.640.11		191.840.11		
4,76	19,05	50,8		191.005.11			
5	17	60	191.650.11		191.850.11		
6	27	70	191.060.11		191.860.11		
6,35	19,05	50,8		191.007.11			
6,35	25,4	63,5		191.008.11			
7	32	80			191.870.11		
7,94	25,4	76,2					191.501.11
8	22	70			191.080.11		
8	32	80			191.081.11		
8	42	90			191.082.11		
9	32	83				191.890.11	
9,53	31,75	76,2					191.503.11
10	32	80			191.800.11		
10	32	83				191.900.11	
10	42	90				191.901.11	
12	35	83			191.820.11	191.120.11	
12	42	90				191.121.11	
12	52	100				191.122.11	
12,7	31,75	76,2					191.505.11
12,7	38,1	88,9					191.506.11
12,7	50,8	101,6					191.507.11

Saw blades

Jig saw blades

Tools with bore & knives

Router bits & sets

CNC router cutter & chucks

Industrial dowel drills

Bits for hand power tools

Power tools & accessories

Display cabinets & spare parts

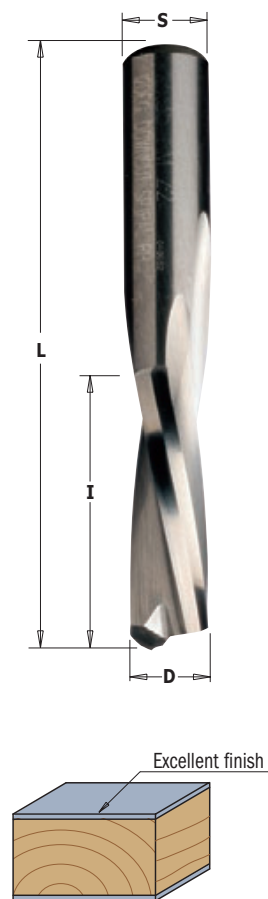

192 Downcut spiral

HWM Z2 RH

D mm	I mm	L mm	ORDER NO. S=Ø6mm	ORDER NO. S=Ø6,35mm	ORDER NO. S=Ø8mm	ORDER NO. S=Ø12mm	ORDER NO. S=Ø12,7mm
3	12	60	192.630.11		192.830.11		
3,18	12,7	50,8		192.001.11			
3,97	12,7	50,8		192.003.11			
4	15	60	192.640.11		192.840.11		
4,76	19,05	50,8		192.005.11			
5	17	60	192.650.11		192.850.11		
6	27	70	192.060.11		192.860.11		
6,35	19,05	50,8		192.007.11			
6,35	25,4	63,5		192.008.11			
7,94	25,4	76,2					192.501.11
8	22	70			192.080.11		
8	32	80			192.081.11		
8	42	90			192.082.11		
9,53	31,75	76,2					192.503.11
10	32	80			192.800.11		
10	32	83				192.900.11	
12	35	83			192.820.11	192.120.11	
12,7	31,75	76,2					192.505.11
12,7	38,1	88,9					192.506.11
12,7	50,8	101,6					192.507.11

Straight bits

HW HWM Z1 Z2 RH

7/8/911

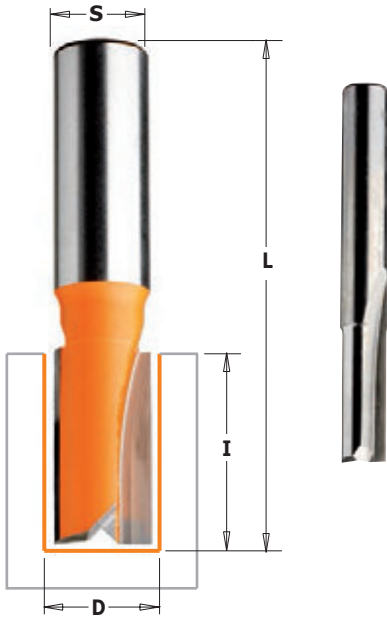

If you are looking to get the most out of your time and money through more efficient production, but want nothing less than a beautiful clean edge on your finished piece, then you definitely must include CMT straight bits in your collection. These razor-sharp, double-faced cutters perfectly synthesize the characteristics and advantages that define quality CMT products. Made of special Fatigue Proof™ steel and micro-grain carbide, our straight bits can withstand even the heaviest work load and still give you a smooth, precise cut every time. You also get exceptional chip ejection to allow cleaner and more constant cutting. The surface of all CMT bits is protected with our trademark orange non-stick PTFE to help keep the bit from collecting resin, pitch and other residue.

Every bit is submitted to strict quality tests to guarantee perfect cutting tolerance, balance and concentricity. CMT bits allow production on an industrial scale using a variety of plywood, composites and natural woods.

CMT produces 91 types of straight bits in a wide range of diameters so you can find exactly what you want.

The cutting edge top sharpening on 9mm diameter bits and larger allows for short plunging operations.

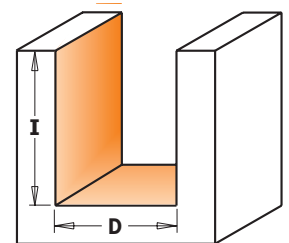

Drawing is 1:1 scale

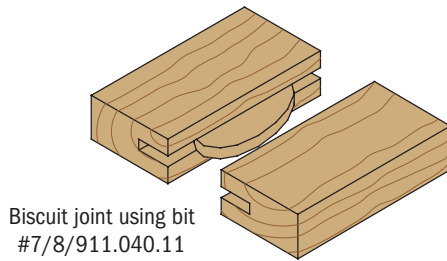

Biscuit joint using bit #7/8/911.040.11

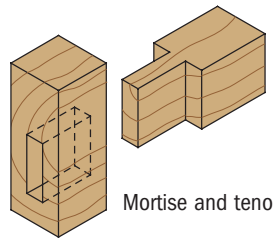

Mortise and tenon

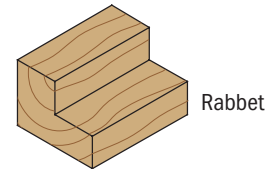

Rabbet

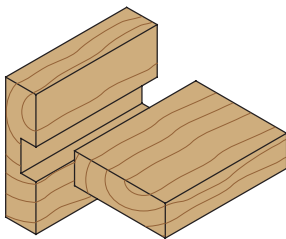

Right-angle joint

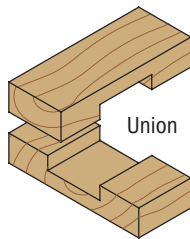

Union

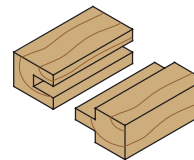

Tongue and groove joint

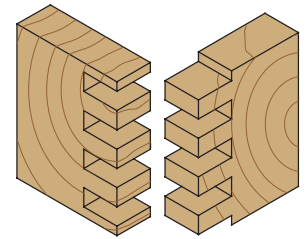

Box joint

Plywood groove set

811

HW HWM Z2 RH



Our plywood groove bits are designed specifically for routing grooves and dadoes for joints in plywood. That means they match the true thickness of plywood, producing tight, accurate joints. Use our 18,2mm bit for 19mm plywood, 12,3mm bit for 12,7mm plywood and our 6mm for 6,35mm ply. No gaps or sloppy joints, guaranteed. These money-saving 3-bit sets are available with 12,7mm or 6,35 shanks.

Example shown in 12,7mm thick plywood

This joint is made with the CMT 12,3mm straight bit in 12,7mm plywood. Notice the precise fit - no gaps.

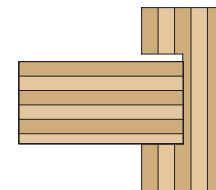
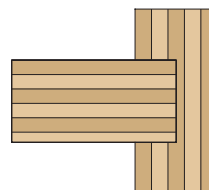

This joint is made with a regular 12,7mm straight bit in 12,7mm plywood. Notice the extra space and ill fitting joint.

DESCRIPTION	ORDER NO. S=Ø6,35mm	ORDER NO. S=Ø12,7mm
Plywood groove set (Ø6 - Ø12,3 - Ø18,2mm)	811.001.11	811.501.11

Saw blades
Jig saw blades
Tools with bore & Knives
Router bits & sets
CNC router cutter & chucks
Industrial dowel drills
Bits for hand power tools
Power tools & accessories
Display cabinets & spare parts

D mm	I mm	L mm	ORDER NO. S=Ø6mm	ORDER NO. S=Ø6,35mm	ORDER NO. S=Ø8mm	ORDER NO. S=Ø12mm	ORDER NO. S=Ø12,7mm
• 2*	4	50	711.020.11	811.020.11			
• 3	8	45	711.030.11	811.030.11			
• 3	8	50			911.030.11		
• 3	8	58,3				911.530.11	
• 3,2	9,5	45		811.032.11			
• 4	10	58,3				911.540.11	
• 4	10	45	711.040.11	811.040.11			
• 4	10	50			911.040.11		
• 4,75	12,7	50,8		811.047.11			
• 5	12	50	711.050.11	811.050.11	911.050.11		
• 5	12	58,3				911.550.11	
• 6	16	50	711.060.11	811.060.11	911.060.11		
• 6	19	63,5				911.560.11	811.560.11
• 6,35	19	50,8		811.064.11			
• 6,35	19	57,2		811.065.11			
• 6,35	19	63,5					811.564.11
• 7	18	50	711.070.11	811.070.11	911.070.11		
• 7	18	63,5				911.570.11	
• 7,6	20	50			911.076.11		
• 8	20	50	711.080.11	811.080.11	911.080.11		
• 8	25,4	70		811.081.11			
• 8	25,4	70					811.581.11
9	20	48	711.090.11		911.090.11		
9,5	19	50,8		811.095.11			
9,5	25,4	63,5		811.096.11			
9,5	25,4	66,7					811.595.11
10	20	48	711.100.11	811.100.11	911.100.11		
10	25,4	63,5					811.600.11
11	20	48	711.110.11		911.110.11		
12	20	50	711.120.11	811.120.11	911.120.11		
12	25,4	63,5				911.620.11	811.620.11
12,3	25,4	57,2		811.123.11			
12,3	25,4	63,5					811.623.11
12,7	19	57,2		811.127.11			
12,7	25,4	66,7					811.627.11
12,7	31,7	82,5					811.628.11
13	20	57	711.130.11		911.130.11		
14	20	50	711.140.11	811.140.11	911.140.11		
14,2	14,2	57,2		811.142.11			
15	20	57,2	711.150.11	811.150.11	911.150.11		
15,8	19	66,7		811.158.11			
15,8	25,4	63,5					811.660.11
16	20	57,2	711.160.11	811.160.11	911.160.11		
16	25,4	63,5					811.661.11
17	20	50	711.170.11				
18	20	50	711.180.11	811.180.11	911.180.11		
18,2	25,4	57,2		811.182.11			
18,2	25,4	63,5					811.682.11
19	20	57,2	711.190.11	811.191.11	911.190.11		
19	25,4	63,5					811.690.11
20	20	50	711.200.11	811.200.11	911.200.11		
22	20	57,2	711.220.11	811.220.11	911.220.11		
24	20	50	711.240.11		911.240.11		
25	20	50	711.250.11		911.250.11		
25,4	19	50,8		811.254.11			
25,4	31,7	76,2					811.754.11
28,5	31,7	76,2					811.785.11
10 pcs. in masterpack							
9,5	25,4	63,5					811.096.11-X10

• HWM
* Z1



Masterpack

Straight bits, long series

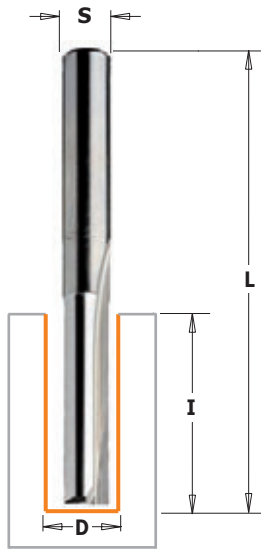
HW HWM Z2 RH

7/8/912

SAFETY PRECAUTIONS: never use damaged or worn bits. Always work at the proper feed rate without forcing the bit. Pay particular attention when making the initial cut with a small diameter bit. For best results when working with small diameter bits, make the cut in more than one pass.

The cutting edge top sharpening on 9mm diameter bits and larger allows for short plunging operations.

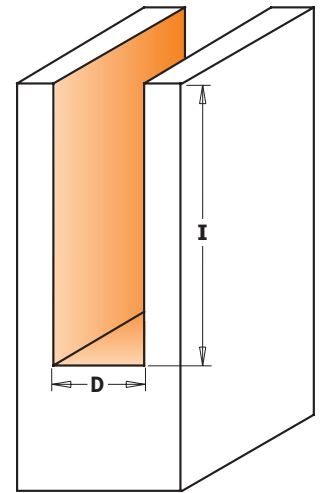

Drawing is 1:1 scale



Masterpack

D mm	I mm	L mm	ORDER NO. S=Ø6mm	ORDER NO. S=Ø6,35mm	ORDER NO. S=Ø8mm	ORDER NO. S=Ø12mm	ORDER NO. S=Ø12,7mm
• 3	11	60	712.030.11				
• 3,2	12,7	50,8		812.032.11			
• 4	12	60	712.040.11				
• 5	18	60	712.050.11				
• 6	25,4	60	712.060.11	812.060.11	912.060.11		
• 6,35	25,4	60		812.064.11			
• 8	31,7	60	712.080.11	812.080.11	912.080.11		
• 8	31,7	75				912.580.11	
9	31,7	75				912.590.11	
9,5	31,7	63,5		812.095.11			
9,5	31,7	73					812.595.11
10	31,7	60	712.100.11	812.100.11	912.100.11		
10	31,7	70					812.600.11
10	31,7	74				912.600.11	
11,1	31,7	82,5					812.611.11
12	31,7	60	712.120.11	812.120.11	912.120.11		
12	31,7	70					812.620.11
12	38,1	95				912.621.11	812.621.11
12	50,8	108				912.622.11	
12,7	31,7	70		812.127.11	912.127.11		
12,7	38,1	95					812.627.11
12,7	50,8	108					812.628.11
12,7	63,5	111					812.629.11
14	31,7	60	712.140.11	812.140.11	912.140.11		
14	31,7	70				912.640.11	
15	31,7	66	712.150.11	812.150.11	912.150.11		
15	31,7	70				912.650.11	
15,8	31,7	70		812.158.11			
16	31,7	66	712.160.11	812.160.11	912.160.11		
16	31,7	70				912.660.11	812.660.11
18	38,1	80				912.681.11	
19	38,1	82,5				912.690.11	812.690.11
19	50,8	92				912.691.11	812.691.11
20	38,1	80				912.701.11	
22	38,1	80				912.721.11	
10 pcs. in masterpack							
12,7	50,8	108					812.628.11-X10

• HWM

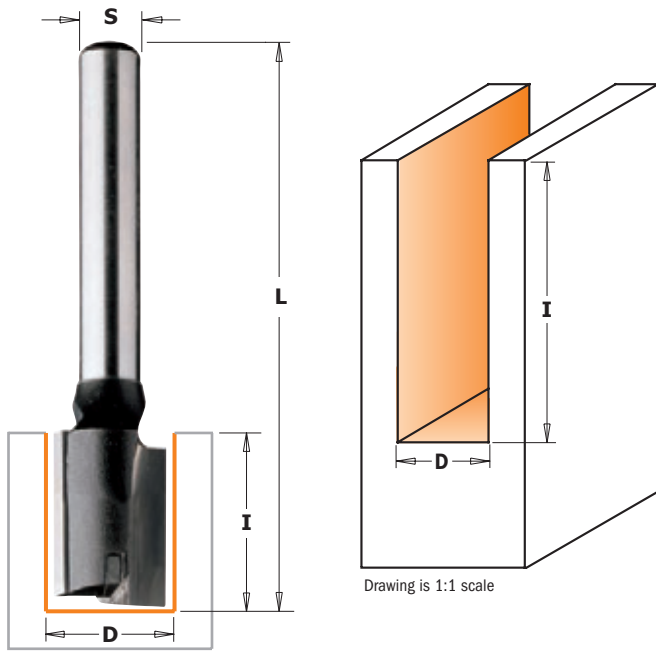

174-177



These industrial straight bits are made a kind of stainless steel specifically created to support hard work on route machines and CNC routers. The cutting plunging edge will allow you to execute any kind of drilling and trimming jobs on soft and hardwood, wood composites and also plastic and laminated materials.

APPLICATION: used for drilling, grooving or jointing solid wood and wood composites. Can be used on machining centres, CNC routers and hand-held routers equipped with chucks or adaptors.

Plunge centre tip

This particular kind of cutting plunging edge allows long-lasting performance on drilling operation.

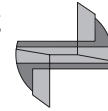

• HWM

D mm	I mm	L mm	ORDER NO. S=Ø12mm
10	35	90	177.100.11
12	35	90	177.120.11
12	50	100	177.121.11
14	35	90	177.140.11
16	35	90	177.160.11
16	60	110	177.161.11
18	35	90	177.180.11
18	60	110	177.181.11
20	35	90	177.200.11
22	35	90	177.220.11
24	35	90	177.240.11
25	35	90	177.250.11
26	35	90	177.260.11
28	35	90	177.280.11
30	35	90	177.300.11
35	35	90	177.350.11

D mm	I mm	L mm	ORDER NO. S=Ø8mm
• 3	10	55	174.030.11
• 4	10	55	174.040.11
• 5	12	55	174.050.11
• 6	14	55	174.060.11
• 7	20	55	174.070.11
8	20	55	174.080.11
8	30	70	174.081.11
8	40	90	174.082.11
9	20	55	174.090.11
10	20	60	174.100.11
10	30	70	174.102.11
10	40	90	174.101.11
11	20	60	174.110.11
12	20	60	174.120.11
12	30	70	174.122.11
12	40	90	174.121.11
13	20	60	174.130.11
14	20	60	174.140.11
14	30	70	174.142.11
14	40	90	174.141.11
15	20	60	174.150.11
16	20	70	174.160.11
16	30	70	174.162.11
16	40	90	174.161.11
18	20	70	174.180.11
18	30	70	174.181.11
18	40	80	174.182.11
19	20	70	174.190.11
20	20	70	174.200.11
20	30	70	174.201.11
20	40	90	174.202.11
22	20	70	174.220.11
22	30	70	174.221.11
22	40	90	174.222.11
24	20	70	174.240.11
24	30	70	174.241.11
24	40	90	174.242.11
25	20	70	174.250.11
26	20	70	174.260.11
26	30	70	174.261.11
28	20	70	174.280.11
28	30	70	174.281.11
29	20	70	174.290.11
30	20	70	174.300.11

Straight cutters with threaded shank

Saw blades

Jig saw blades

Tools with bore & Knives

Router bits & sets

CNC router cutter & chucks

Industrial dowel drills

Bits for hand power tools

Power tools & accessories

Display cabinets & spare parts



HW plunge centre tip



TECHNICAL DETAILS:

- Super strength steel
- 2 HW alternating precision ground cutting edges [Z2+1]

APPLICATION: ideal for cutting openings for electrical boxes and similar operations in solid wood, wood composites, plastics and laminates. Can be used on machining centres, CNC routers and hand-held routers equipped with chucks or adaptors.

170-171-180-181

D mm	I mm	L mm	ORDER NO. S=M12x1
6	18	60	170.060.11
8	23	60	170.080.11
10	23	60	170.100.11
11	23	60	170.110.11
12	23	60	170.120.11
14	23	60	170.140.11
15	25	60	170.150.11
16	25	60	170.160.11
18	25	60	170.180.11
20	25	60	170.200.11
22	25	60	170.220.11
24	25	60	170.240.11
25	25	60	170.250.11
26	25	60	170.260.11
28	25	60	170.280.11
30	25	60	170.300.11
35	25	60	170.350.11
8	35	67	171.080.11
10	35	67	171.100.11
12	35	67	171.120.11
14	35	67	171.140.11
16	35	67	171.160.11
18	35	67	171.180.11
20	35	67	171.200.11
22	35	67	171.220.11
12	45	77	180.120.11
16	45	77	180.160.11
18	45	77	180.180.11
20	45	77	180.200.11
16	60	92	181.160.11
20	60	92	181.200.11



HW plunge centre tip

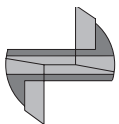

173-182



D mm	I mm	L mm	ORDER NO. S=M10
6	14	50	173.060.11
8	20	52	173.080.11
10	22	52	173.100.11
12	22	52	173.120.11
14	25	52	173.140.11
15	25	52	173.150.11
16	25	52	173.160.11
18	25	52	173.180.11
20	25	52	173.200.11
22	25	52	173.220.11
25	25	52	173.250.11
30	25	52	173.300.11
8	35	67	182.080.11
10	35	67	182.100.11
12	35	67	182.120.11
14	35	67	182.140.11
16	45	77	182.160.11
18	45	77	182.180.11
20	45	77	182.200.11

5%co HS spiral bits for aluminium positive single flute

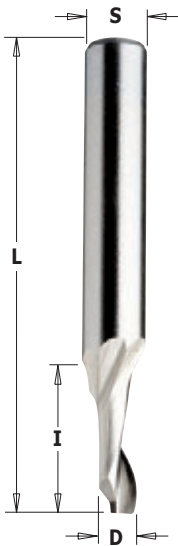

Suggested
MAX RPM 12.000

188

HS Z1 RH

D mm	I mm	L mm	ORDER NO. S=∅8mm
3	12	60	188.030.51
4	12	60	188.040.51
4	40	100	188.041.51
5	14	60	188.050.51
5	40	100	188.051.51
6	14	60	188.060.51
6	40	100	188.061.51
7	14	60	188.070.51
8	14	80	188.080.51
8	40	100	188.081.51
9	14	80	188.090.51
10	14	80	188.100.51
12	14	80	188.120.51

TECHNICAL DETAILS:

- 5%co premium solid HS
- 1 upcut spiral cutting edge
- Upward chip ejection

APPLICATION: these tools feature single flute design allowing both efficient and effective carving on all types of aluminium. The final result? Higher flexibility than traditional bits, enhanced productivity and high quality finishing.

5%co HS spiral bits for aluminium positive single flute for high cutting depth

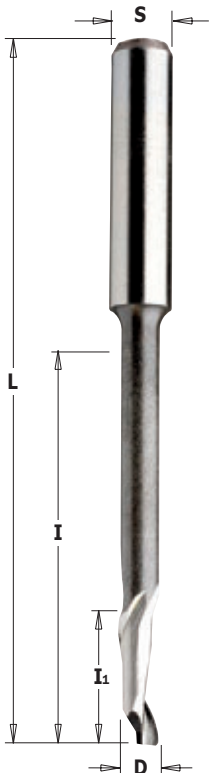

Suggested
MAX RPM 12.000

189

HS Z1 RH

D mm	I mm	I ₁ mm	L mm	S mm	ORDER NO.
4	46	16	90	8	189.040.51
5	35	18	80	8	189.050.51
5	35	14	120	8	189.051.51
5	55	16	90	8	189.052.51
6	45	16	90	8	189.060.51
8	68	14	100	8	189.080.51
8	55	14	80	8	189.081.51
10	95	14	120	10	189.100.51
10	70	30	100	10	189.101.51

TECHNICAL DETAILS:

- 5%co premium solid HS
- 1 upcut spiral cutting edge
- Upward chip ejection

APPLICATION: these tools feature single flute design allowing both efficient and effective carving on all types of aluminium. The final result? Higher flexibility than traditional bits, enhanced productivity and high quality finishing.

Straight router bits with insert knives

INSERT CARBIDE Z1 RH

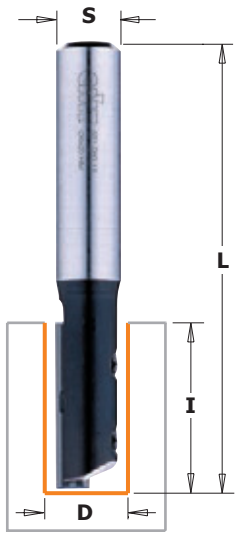

651-652

Straight router bit with one replaceable mini knife and fixing wedge. Radial and axial groove for better and safe knife insertion. For finishing, routing and grooving in board materials (DTD laminated, MDF and hardwood). For use on portable routers or CNC machining centres.

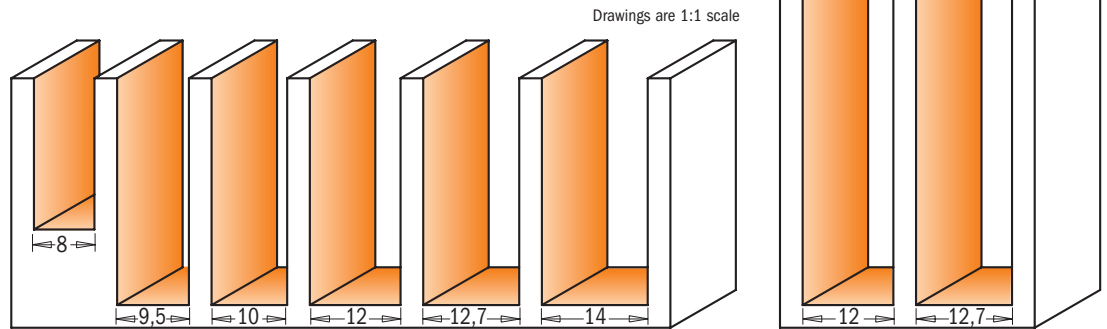

D mm	I mm	L mm	ORDER NO. S=Ø6,35mm	ORDER NO. S=Ø8mm	ORDER NO. S=Ø12mm	ORDER NO. S=Ø12,7mm	Spare parts				
8	20	60	651.079.11								790.200.01 651.999.01 990.070.00 991.063.00
8	20	60		651.080.11							790.200.01 651.999.01 990.070.00 991.063.00
8	20	67			651.081.11	651.681.11					790.200.01 651.999.01 990.070.00 991.063.00
9,5	30	70	651.095.11								790.300.01 651.999.02 990.071.00 991.063.00
9,5	30	80				651.695.11					790.300.01 651.999.02 990.071.00 991.063.00
10	30	70		651.100.11							790.300.01 651.999.02 990.071.00 991.063.00
10	30	80			651.101.11	651.701.11					790.300.01 651.999.02 990.071.00 991.063.00
12	30	70		651.120.11							790.300.01 651.999.02 990.071.00 991.063.00
12	30	80			651.121.11	651.721.11					790.300.01 651.999.02 990.071.00 991.063.00
12	50	103			652.121.11	652.621.11					790.500.01 651.999.03 990.016.00 991.060.00
12,7	30	70	651.127.11								790.300.01 651.999.02 990.071.00 991.063.00
12,7	30	80				651.727.11					790.300.01 651.999.02 990.071.00 991.063.00
12,7	50	103				652.628.11					790.500.01 651.999.03 990.016.00 991.060.00
14	30	73		651.140.11							790.300.01 651.999.02 990.071.00 991.063.00

Straight router bits with insert knives for laminates

INSERT CARBIDE Z1 RH



652

Straight trimmer bits with one replaceable knife fixed by Tox screw. For economical specialist application s requiring low down-time. The 29,5x9x1,5mm knives provide a 40mm cutting length when operating in multiple passes. For routing, trimming and grooving on board materials (laminated chipboards, worktop panels and MDF). For use on portable routers.

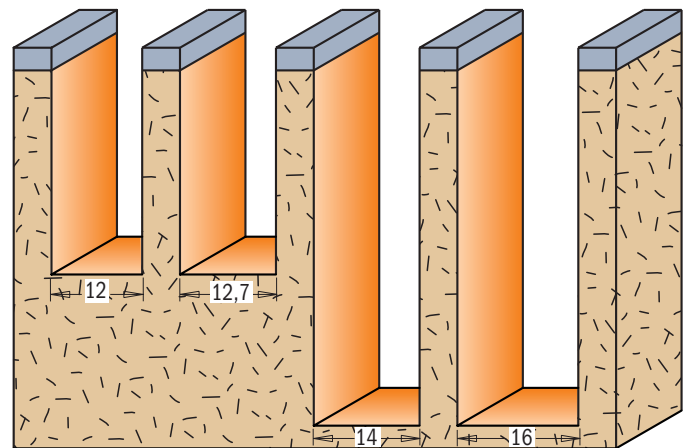

D mm	I mm	L mm	ORDER NO. S=Ø8mm	ORDER NO. S=Ø12mm	ORDER NO. S=Ø12,7mm	Spare parts				
12	29,5	79	652.120.11							790.295.09 990.072.00 991.061.00
12	39,5	90	652.122.11							790.395.09 990.072.00 991.061.00
12,7	29,5	89			652.627.11					790.295.09 990.072.00 991.061.00
14	50	96		652.141.11						790.500.09 990.072.00 991.061.00
16	50	96		652.161.11						790.500.09 990.072.00 991.061.00

Saw blades
Jig saw blades
Tools with bore & Knives
Router bits & sets
CNC router cutter & chucks
Industrial dowel drills
Bits for hand power tools
Power tools & accessories
Display cabinets & spare parts

Straight router bits with insert knives

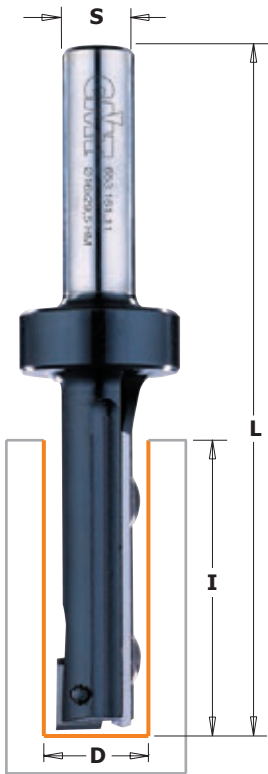

653

Straight router bits with on replaceable plunging knife and side knife fixed by a special Torx screw. The tool bodies are precisely balanced. For finishing, routing, plunging and grooving on board materials (laminated chipboards and MDF) and hardwood. For use on portable routers or CNC machining centres.

INSERT CARBIDE Z1+1 RH

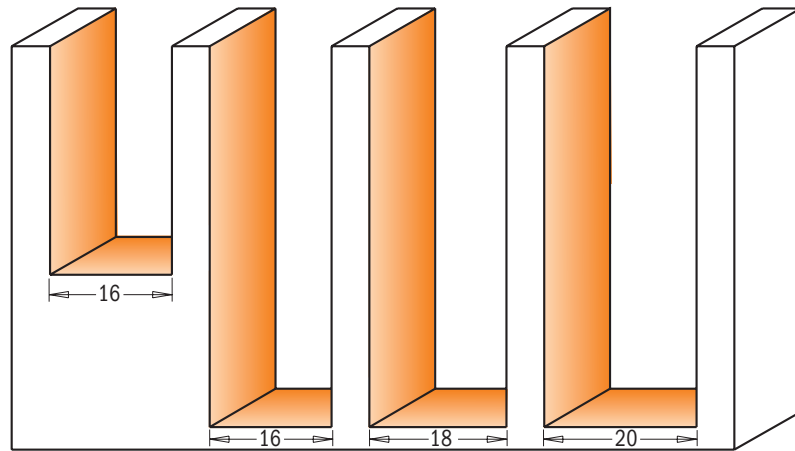

Drawings are 1:1 scale

D mm	I mm	L mm	ORDER NO.				Spare parts					
			S=Ø8mm	S=Ø12mm	S=Ø12,7mm	S=Ø20mm						
15,8	28,3	91			653.158.11		790.283.12	990.074.00	990.075.00	790.075.00	990.072.00	991.061.00
15,8	48,3	111			653.159.11		790.483.12	990.074.00	990.075.00	790.075.00	990.072.00	991.061.00
16	28,3	81	653.160.11				790.283.12	990.074.00	990.075.00	790.075.00	990.072.00	991.061.00
16	28,3	91		653.161.11		653.661.11	790.283.12	990.074.00	990.075.00	790.075.00	990.072.00	991.061.00
16	48,3	111		653.162.11		653.662.11	790.483.12	990.074.00	990.075.00	790.075.00	990.072.00	991.061.00
18	48,3	111				653.681.11	790.483.12	990.074.00	990.075.00	790.075.00	990.072.00	991.061.00
20	48,3	111				653.701.11	790.483.12	990.074.00	990.075.00	790.096.00	990.072.00	991.061.00

Straight router bits with insert knives



655

654

Straight router bit with two replaceable knives fixed by special Torx screws. Their blades are sharpened on the top with 3° angle for better plunging operations.

INSERT CARBIDE Z2 RH

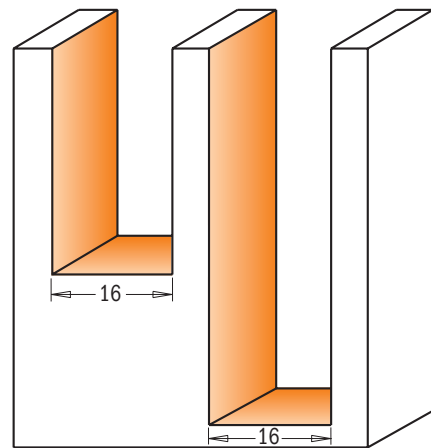

Drawings are 1:1 scale

D mm	I mm	L mm	ORDER NO.				Spare parts		
			S=Ø8mm	S=Ø12mm	S=Ø12,7mm	S=Ø20mm			
16	28,3	76	654.160.11				790.283.12	990.073.00	991.061.00
16	28,3	86		654.161.11	654.661.11		790.283.12	990.073.00	991.061.00
16	48,3	105		654.162.11		654.662.11	790.483.12	990.073.00	991.061.00
19	12	45	655.190.11				790.120.00	990.075.00	991.061.00

Mortising bits

Saw blades
Jig saw blades
Tools with bore & Knives
Router bits & sets
CNC router cutter & chucks
Industrial dowel drills
Bits for hand power tools
Power tools & accessories
Display cabinets & spare parts

7/8/901B



Equipped with thick carbide tips and negative shear angle design, CMT mortising bits guarantee you flawless performance. Mortise perfect hinges with no splintered edges or rough bottoms. They also make an easy job on both natural wood and wood composites. Fit most popular mortising jigs. The CMT mortising bit with top bearing guide is the perfect bit for sign making or any kind of template work.

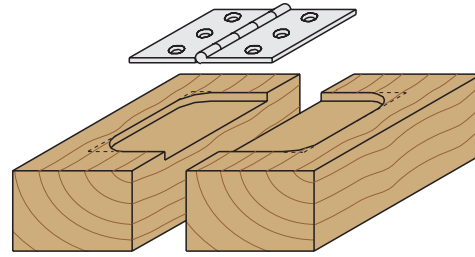
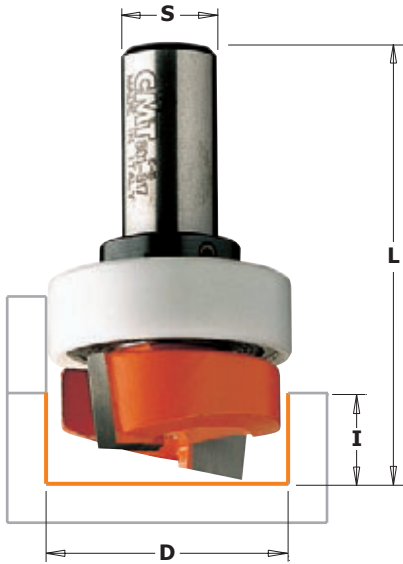

Example of usage of a CMT mortising bit to fit a hinge.

7/8/901

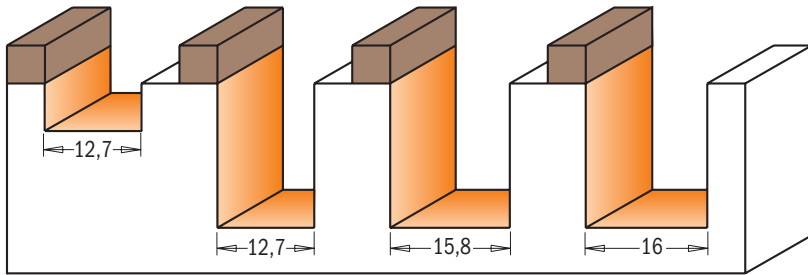

Drawings are 1:1 scale

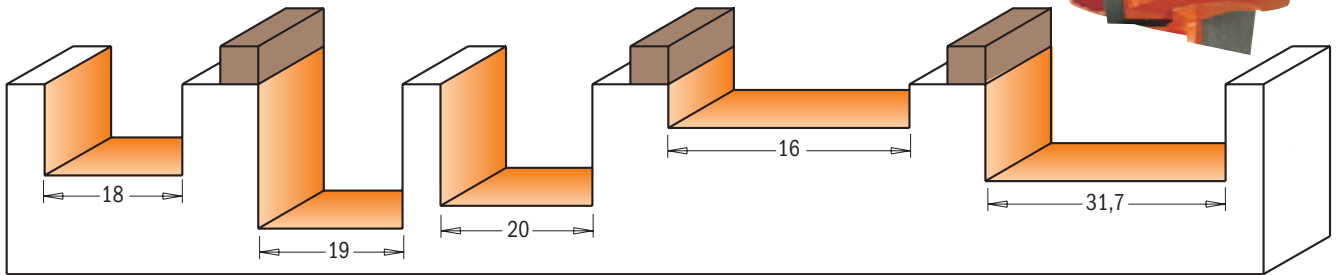

D mm	I mm	L mm	ORDER NO. S=Ø6mm	ORDER NO. S=Ø6,35mm	ORDER NO. S=Ø8mm	ORDER NO. S=Ø12mm	ORDER NO. S=Ø12,7mm
12,7	6,35	41		801.128.11			
12,7	19	54	701.127.11	801.127.11	901.127.11		
12,7	19	60				901.627.11	801.627.11
15,8	19	57		801.158.11			
16	19	54	701.160.11		901.160.11		
18	16	48	701.180.11		901.180.11		
19	19	54	701.190.11	801.190.11	901.190.11		
19	19	57					801.690.11
20	16	48	701.200.11		901.200.11		
31,7	5,7	63					801.818.11
31,7	12,7	48		801.317.11			
31,7	12,7	54				901.817.11	801.817.11
with top bearing							
12,7	6,35	41		801.128.11B			
12,7	19	54		801.127.11B			
15,8	19	57		801.158.11B			
16	19	54			901.160.11B		
19	19	54	701.190.11B				
19	19	54		801.190.11B			
31,7	5,7	63					801.818.11B
31,7	12,7	54					801.817.11B

Spare parts



791.010.00	541.001.00	991.056.00
791.010.00	541.001.00	991.056.00
791.009.00	541.001.00	991.056.00
791.025.00	541.004.00	991.056.00
791.007.00	541.003.00	991.056.00
791.004.00	541.001.00	991.056.00
791.015.00	541.002.00	991.056.00
791.015.00	541.002.00	991.056.00

Hinge recesser bits



7/902

CMT hinge recesser bits are ideal for shallow lateral routing cuts such as recessing hinges.

SHOP TIPS: corners will require final square with a hand or a corner chisel.

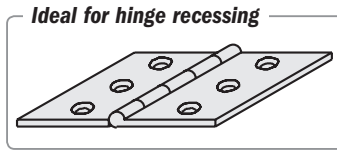

The special construction allows good chip clearance and plunging.

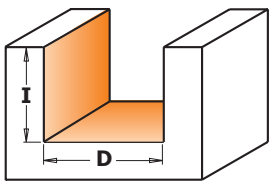

Drawing is 1:1 scale

D mm	I mm	L mm	ORDER NO. S=Ø6mm	ORDER NO. S=Ø8mm
12	12	38	702.120.11	902.120.11
13	12	38	702.130.11	902.130.11
14	12	38	702.140.11	902.140.11
15	12	38	702.150.11	902.150.11
16	12	38	702.160.11	902.160.11
18	12	38	702.180.11	902.180.11
20	11	38	702.200.11	902.200.11
22	11	38	702.220.11	902.220.11
23	11	38	702.230.11	902.230.11
24	11	38	702.240.11	902.240.11
25	11	38	702.250.11	902.250.11

Dado & Planer bits

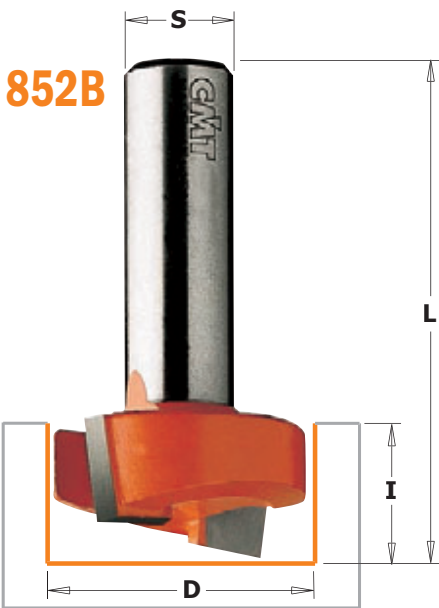

852B

852

Constructed with thick carbide tips and downward shear angle design, CMT mortising bits give you flawless performance. The negative shear angle of the cutting edges pushes the wood fibers down as they cut, allowing you to rout perfect hinge mortises with no splintered edges or rough bottoms. They also make an easy job on both natural wood and wood composites. We offer bits to fit the most popular mortising jigs.

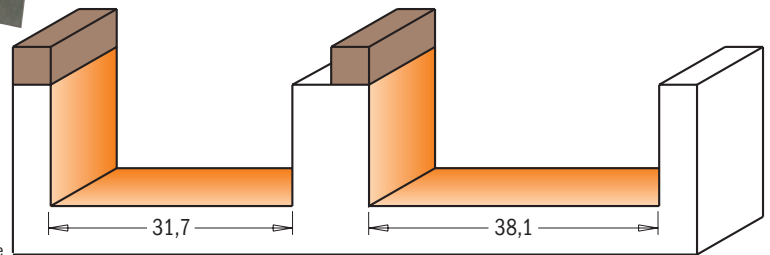
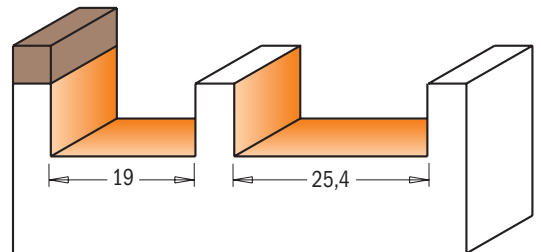

Drawings are 1:1 scale

D mm	I mm	L mm	ORDER NO. S=Ø6,35mm	ORDER NO. S=Ø12,7mm
19	9,5	57	852.001.11	
19	9,5	63,5		852.501.11
25,4	9,5	57		852.502.11
31,7	15,8	70		852.503.11
38,1	15,8	70		852.504.11
with top bearing				
19	9,5	57	852.001.11B	
19	9,5	63,5		852.501.11B
31,7	15,8	70		852.503.11B
38,1	15,8	70		852.504.11B

Spare parts



791.004.00	541.001.00	991.056.00
791.011.00	541.002.00	991.056.00
791.015.00	541.002.00	991.056.00
791.020.00	541.002.00	991.056.00

Pattern bits

7/8/912B

7/8/911B

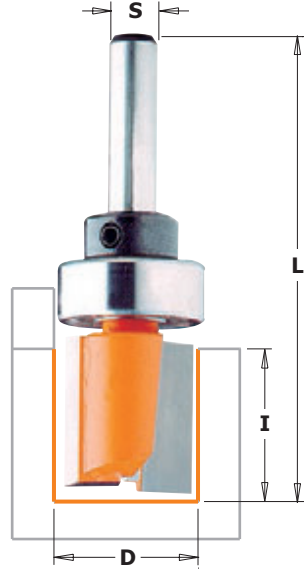

Whether you are a full time professional or a part time woodworking enthusiast, discover the unlimited possibilities of template routing with a CMT pattern bit. Pair up these double fluted bits with your choice of template to produce cabinet and furniture pieces, signs, toys and any other creative projects. Carbide tipped to last longer, CMT pattern bits are equipped with top bearing for working with the bearing above the wood piece. This gives you a clear view of what you are routing so you can work confidently and accurately.

SAFETY TIPS: Make sure your router is in top condition. The template must be securely fastened to the workpiece. When choosing a bit, carefully consider the thickness of the template and all the implications of the cut. Opt for the shortest bit possible for the project you are working on.

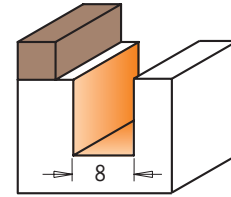

811.081.11B

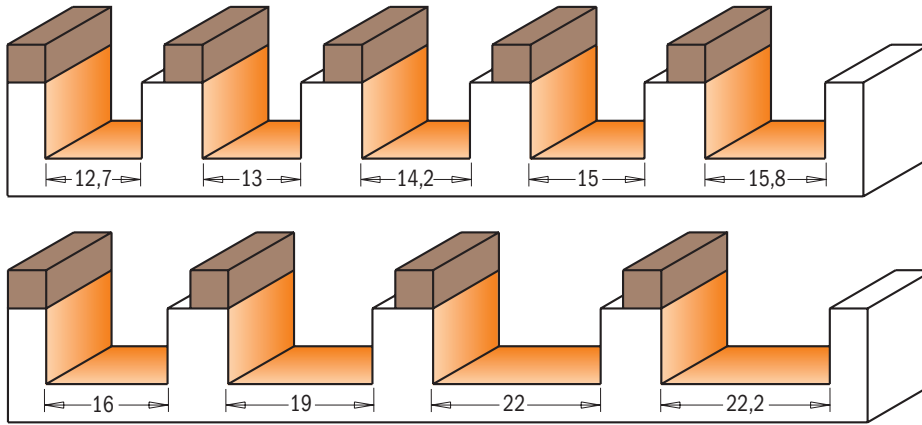

Drawings are 1:1 scale

D mm	I mm	L mm	ORDER NO. S=Ø6mm	ORDER NO. S=Ø6,35mm	ORDER NO. S=Ø8mm	ORDER NO. S=Ø12mm	ORDER NO. S=Ø12,7mm	Spare parts		
8	25,4	70		811.081.11B						
12,7	19	57		811.127.11B				791.010.00	541.001.00	991.056.00
13	20	57	711.130.11B					791.023.00	541.003.00	991.056.00
14,2	14,2	57		811.142.11B				791.009.00	541.001.00	991.056.00
15	20	57	711.150.11B					791.024.00	541.003.00	991.056.00
15,8	12,7	58		811.159.11B				791.009.00	541.001.00	991.056.00
15,8	19	66,5		811.158.11B				791.009.00	541.001.00	991.056.00
16	20	57			911.160.11B			791.025.00	541.004.00	991.056.00
19	20	57	711.190.11B					791.007.00	541.003.00	991.056.00
19	20	57		811.191.11B				791.004.00	541.001.00	991.056.00
19	25,4	63,5					811.690.11B	791.011.00	541.002.00	991.056.00
22	20	57			911.220.11B			791.005.00	541.004.00	991.056.00
22,2	25,4	66,5					811.222.11B*	791.021.00	541.006.00	991.056.00
long series										
12,7	31,7	70		812.127.11B				791.010.00	541.001.00	991.056.00
15	31,7	66,5	712.150.11B					791.024.00	541.003.00	991.056.00
15,8	31,7	70		812.158.11B				791.009.00	541.001.00	991.056.00
16	31,7	66,5			912.160.11B			791.025.00	541.004.00	991.056.00
19	38,1	82,5				912.690.11B		791.011.00	541.005.00	991.056.00
19	38,1	82,5					812.690.11B	791.011.00	541.002.00	991.056.00
19	50,8	92				912.691.11B		791.011.00	541.005.00	991.056.00
19	50,8	92					812.691.11B	791.011.00	541.002.00	991.056.00

This item requires a slightly larger bearing than its cutting diameter
 *Ø9,5mm shanks with Ø9,5/12,7mm bushings (799.001.00)

Saw blades
Jig saw blades
Tools with bore & Knives
Router bits & sets
CNC router cutter & chucks
Industrial dowel drills
Bits for hand power tools
Power tools & accessories
Display cabinets & spare parts



652B

Straight router bits with on replaceable knife fixed by a Torx screw. For economical specialist applications requiring low downtime. They are equipped with top bearing for template use. For routing, trimming and grooving in board materials (laminated chipboards, worktop panels, MDF). For use on portable routers.

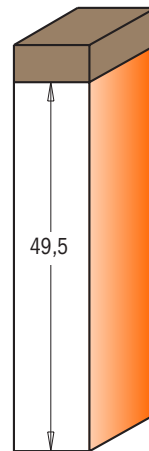

Drawing is 1:1 scale

D mm	I mm	L mm	ORDER NO. S=Ø12mm	ORDER NO. S=Ø12,7mm	Spare parts					
19	49,5	100	652.690.11B	652.691.11B						
					790.495.09	990.072.00	991.061.00	791.011.00	541.002.00	991.056.00

Pattern router bits with insert knives for laminates



656

This bit type is equipped with top bearing for template use. For finishing, routing and grooving in board materials (laminated chipboards, MDF) and hardwood. Fors use on portable routers or CNC machining centres.

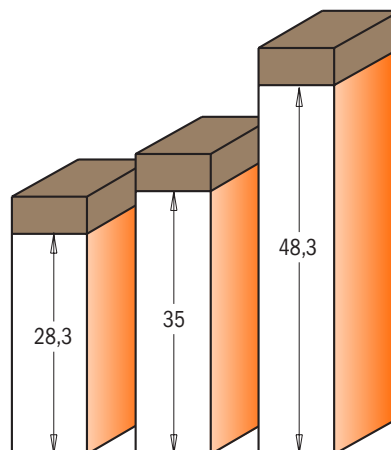

Drawings are 1:1 scale

D mm	I mm	L mm	ORDER NO. S=Ø8mm	ORDER NO. S=Ø12mm	ORDER NO. S=Ø12,7mm	Spare parts					
16	35	80	656.160.11								
19	28,3	69	656.190.11			790.283.12	990.075.00	991.061.00	791.025.00	541.004.00	991.056.00
19	28,3	79			656.691.11	790.283.12	990.075.00	991.061.00	791.011.00	541.002.00	991.056.00
19	48,3	100		656.692.11	656.693.11	790.483.12	990.075.00	991.061.00	791.011.00	541.002.00	991.056.00

Weatherseal bits

HWM Z2 RH



7/813.001

191.635

711.031

712.030
712.040
812.032

Make your house more energy efficient by insulating old doors and windows. A CMT Weatherseal bit is the perfect bit to re-groove door and window frames to accommodate wind blocking inserts. Made of solid carbide for strength and endurance.

Special economical double-sided design lets you save money by offering two tips in one bit; with the same features as the one-sided weatherseal bit. Only available with a 3mm (1/8") cutting diameter.

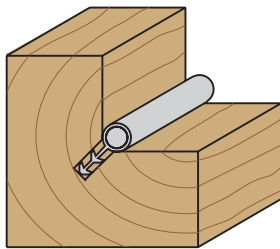
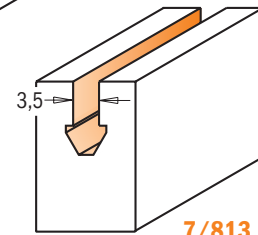
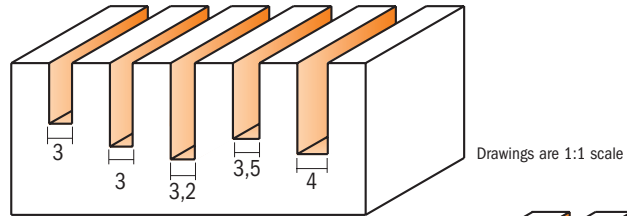

D mm	I mm	L mm	ORDER NO. S=Ø6mm	ORDER NO. S=Ø6,35mm
3	8	70	711.031.11	
3	11	60	712.030.11	
3,2	12,7	50,8		812.032.11
3,5	10	60	191.635.11	
4	12	60	712.040.11	
3,5	8	70	713.001.11	
3,5	8	63,5		813.001.11

Combination trimmer bits

HW Z2 RH

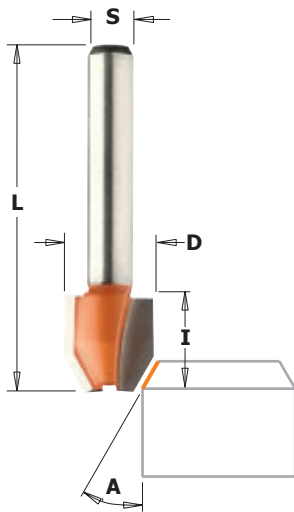

7/8/921

Work to your highest standards with the CMT combination trimmer bits. Now you can cut, trim and bevel all laminated without changing the bits. Achieve great results in straight or angled cuts on both soft and hardwood. Three popular sizes, each with carbide-tipped cutting edges for efficient bevel and straight trimming.

NOTICE: these bits must be used with an edge, separate guide or fence.

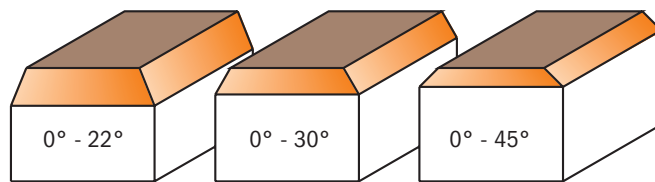

A	D mm	I mm	L mm	ORDER NO. S=Ø6mm	ORDER NO. S=Ø6,35mm	ORDER NO. S=Ø8mm
0° - 22°	12	12,7	44,5	721.022.11	821.022.11	
0° - 30°	12	12,7	44,5	721.030.11	821.030.11	921.030.11
0° - 45°	12	12,7	44,5	721.045.11	821.045.11	

Combination trimmer bits

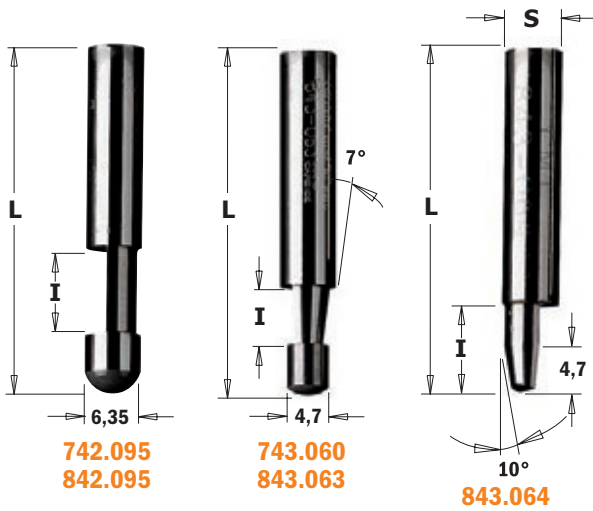

7/842 - 7/843



Work to your highest standards with the CMT combination trimmer bits. Now you can cut, trim and bevel all laminated without changing the bits. Achieve great results in straight or angled cuts on both soft and hardwood. Three popular sizes, each with carbide-tipped cutting edges for efficient bevel and straight trimming.

NOTICE: these bits must be used with an edge, separate guide or fence.



Masterpack

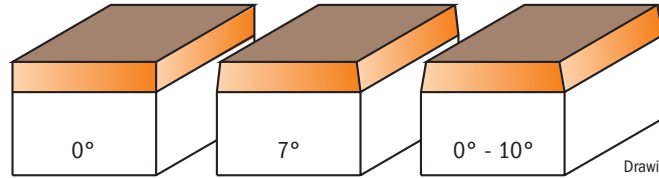

Drawings are 1:1 scale

A	D mm	I mm	L mm	ORDER NO. S=Ø6mm	ORDER NO. S=Ø6,35mm
0°	6	9,5	38,1	742.095.11	
0°	6,35	9,5	38,1		842.095.11
7°	6	6	38,1	743.060.11	
7°	6,35	6,35	38,1		843.063.11
0° - 10°	6,35	9,5	38,1		843.064.11
50 pcs. in masterpack					
0°	6,35	9,5	38,1		842.095.11-X50
7°	6,35	6,35	38,1		843.063.11-X50

Combination trimmer bits

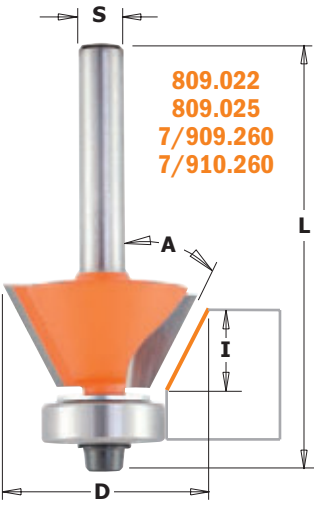

7/907 - 7/8/909 - 7/910

Using the CMT's combination flush and bevel trim bits is the easiest and most precise way to put execute finishing on laminates. No bit changing is necessary to achieve a large variety of angles; simply lower the bit cutting depth for perfect right angle cuts, or raise it for creating rounded off edges on both soft and hardwood.

These bits include ball bearing guide for easy template work and for guaranteeing the protection of your workpiece. Also they feature two flutes for smoother cutting and are perfect for rounding off table legs and other soft areas on furniture pieces that may be easily damaged.

Drawings are 1:1 scale

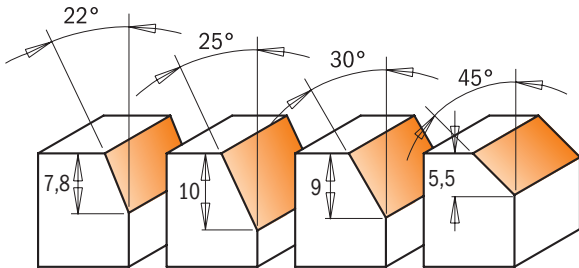

NON BLOCKING



7/907.210



7/809.016



809.023
Z3

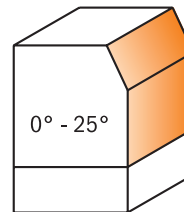

0° - 25°

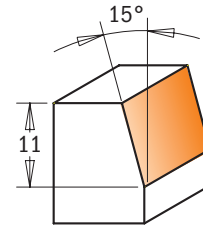

15°

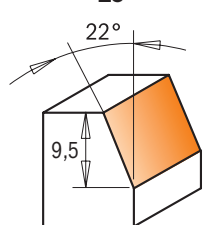

22°

A	D mm	I mm	L mm	Z	ORDER NO. S=Ø6mm	ORDER NO. S=Ø6,35mm	ORDER NO. S=Ø8mm	Spare parts			
0° - 25°	19 - 24,5	16 (10+6)	56,5	2	707.210.11		907.210.11				
new 15°	18,6	11	57	2	709.016.11	809.016.11		791.007.00	990.004.00	991.062.00	
22°	12,7	7,8	47,6	2		809.022.11		990.422.00	791.044.00	990.058.00	991.057.00
new 22°	17,5	9,5	51	3		809.023.11		791.035.00	990.062.00	991.060.00	
25°	19,05	10	52,4	2		809.025.11		990.422.00	791.002.00	990.058.00	991.057.00
30°	27	9	55	2	709.260.11		909.260.11	990.422.00	791.002.00	990.058.00	991.057.00
45°	27	5,5	51,5	2	710.260.11		910.260.11	990.423.00	791.018.00	990.058.00	991.057.00
								990.423.00	791.018.00	990.058.00	991.057.00

Flush trim bits



7/8/906

We have designed a series of truly indispensable bits available in a wide range of sizes for your woodworking needs and your most difficult projects. For precision work on laminates or quick template work with excellent finishing.

SHOP TIPS: these bits are excellent for making through mortises. Use a straight bit (#711.130.11) to groove the through mortise area, then use the drill bit (#517.130.31) to bore a through hole at the end of the groove. Turn the workpiece over to end the mortise. Use the flush trim bit with a cutting length slightly longer than the fillet, following the groove made on the opposite side of the workpiece with the ball bearing guide.

new

8/906.227.11
Z3

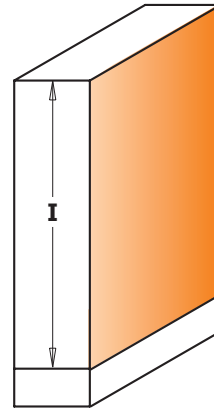
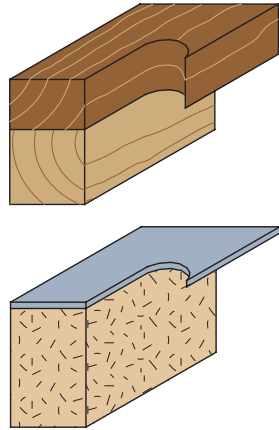

Masterpack

Drawing is 1:1 scale

• **HWM**

I mm	D mm	L mm	Z	ORDER NO. S=Ø6mm	ORDER NO. S=Ø6,35mm	ORDER NO. S=Ø8mm	ORDER NO. S=Ø12mm	ORDER NO. S=Ø12,7mm
•25,4	6,35	63,5	2	706.064.11	806.064.11			
12,7	9,5	55,5	2	706.096.11	806.096.11	906.096.11		
12,7	12,7	57,8	2	706.128.11	806.128.11	906.128.11		
12,7	12,7	70,6	2				906.628.11	806.628.11
16	19	57,1	2	706.190.11		906.190.11		
25,4	9,5	68,2	2	706.095.11	806.095.11	906.095.11		
25,4	12,7	70,7	2	706.127.11	806.127.11	906.127.11		
new 25,4	12,7	71	3		806.227.11	906.227.11		
25,4	12,7	86,6	2				906.627.11	806.627.11
38,1	12,7	94	2				906.629.11	806.629.11
50,8	12,7	103,7	2				906.630.11	806.630.11
10 pcs. in masterpack								
25,4	9,5	68,2	2		806.095.11-X10			
25,4	12,7	70,7	2		806.127.11-X10			806.627.11-X10
38,1	12,7	94	2					806.629.11-X10

Spare parts



791.035.00	541.350.00	
791.002.00	990.422.00	990.058.00
791.003.00	990.423.00	990.058.00
791.003.00	990.423.00	990.058.00
791.007.00		990.004.00
791.002.00	990.422.00	990.058.00
791.003.00	990.423.00	990.058.00
791.003.00	990.423.00	990.058.00
791.003.00	990.423.00	990.058.00
791.003.00	990.423.00	990.058.00
791.003.00	990.423.00	990.058.00
791.003.00	990.423.00	990.058.00

Spare parts
991.057.00 3/32" hex key for screw (990.058.00)
991.062.00 2,5mm hex key for screw (990.004.00)



Flush trim bit set

806

Indispensable in any shop, the new 3 piece flush trim bit set gives you the option to trim laminates or do template work conveniently.

Set contains:
806.095.11 - 806.096.11 - 806.191.11.

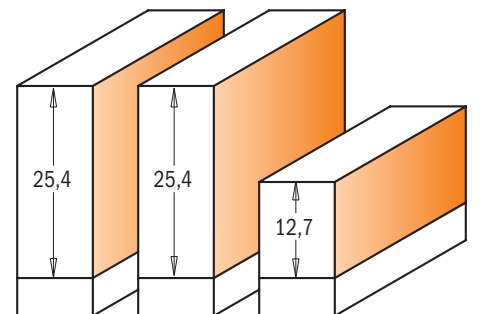

Drawings are 1:1 scale

DESCRIPTION	BITS SIZES mm	ORDER NO. S=Ø6,35mm
Flush trim bit set	9,5x12,7 - 9,5x25,4 - 19x25	806.001.11

Saw blades
Jig saw blades
Tools with bore & Knives
Router bits & sets
CNC router cutter & chucks
Industrial dowel drills
Bits for hand power tools
Power tools & accessories
Display cabinets & spare parts

Super-duty flush trim bits



7/8/906



These new super duty bits represent the finest of the extensive line of CMT flush trim bits with ball bearing guides. A negative shear angle cutting edge and 19mm cutting diameter set CMT flush trim bits apart from standard bits. Work quickly and safely to get a superior finishing with absolute minimal chipping.

SAFETY TIPS: dust and chips from laminate materials are hazardous to your health and safety. Always wear a dust mask and eye protection when routing.

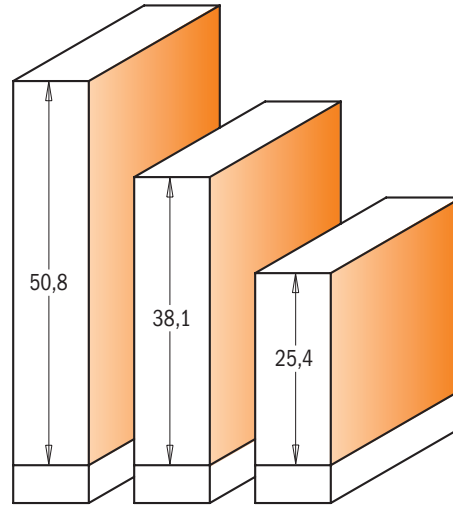
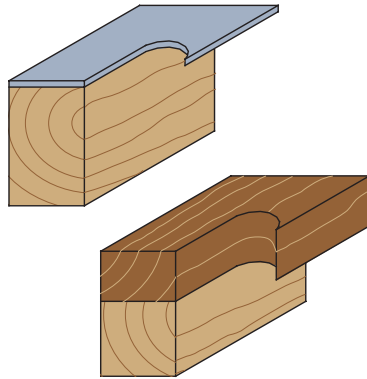

Drawings are 1:1 scale



I mm	D mm	L mm	ORDER NO.	ORDER NO.	ORDER NO.	ORDER NO.	ORDER NO.	Spare parts		
			S=Ø6mm	S=Ø6,35mm	S=Ø8mm	S=Ø12mm	S=Ø12,7mm			
25,4	19	73,9	706.191.11	806.191.11	906.191.11			791.004.00	541.550.00	990.058.00
25,4	19	86,5				906.691.11	806.691.11	791.004.00	541.550.00	990.058.00
38,1	19	92,9				906.692.11	806.692.11	791.004.00	541.550.00	990.058.00
50,8	19	109,5				906.690.11	806.690.11	791.004.00	541.550.00	990.058.00

Spare parts 991.057.00 3/32" hex key for screw (990.058.00)

DP Flush trim bits for laminates

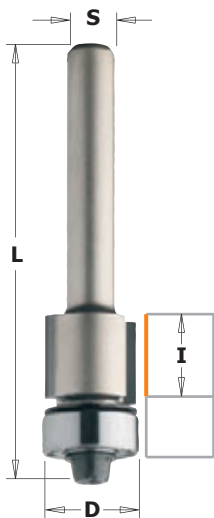

7/8/906 XTREME



These new super duty DP (polycrystalline diamond) bits represent the ultimate in the extensive line of CMT flush trim bits. Investing in CMT DP flush trim bits to save time and money, as they last at least 40 times longer than conventional carbide tipped flush trim bits.

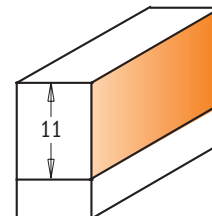
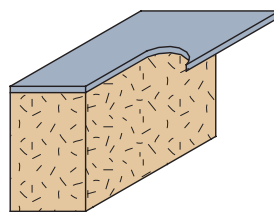

Drawing is 1:1 scale

40X
LONGER LIFE
THAN CARBIDE

I mm	D mm	L mm	ORDER NO.	ORDER NO.	ORDER NO.	Spare parts			
			S=Ø6mm	S=Ø6,35mm	S=Ø8mm				
11	12,7	58,1	706.128.61	806.128.61	906.128.61	990.423.00	791.003.00	990.058.00	991.057.00

Double-bearing spiral flush trim bits

Saw blades
Jig saw blades
Tools with bore & Knives
Router bits & sets
CNC router cutter & chucks
Industrial dowel drills
Bits for hand power tools
Power tools & accessories
Display cabinets & spare parts

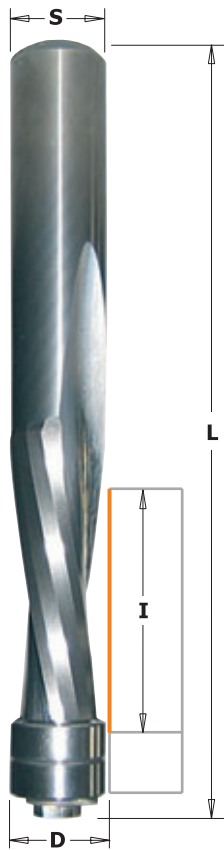

190B-191B-192B

The new CMT solid carbide spiral flush trim bits are manufactured with a special super-micrograin formulation that has increased hardness with a higher transverse rupture point. Combined with the spiral cutting angle, the new CMT solid carbide spiral flush trim bits with double bearing allow the cabinet maker to shear wood and wood products cleanly, providing more efficient chip ejection than standard flush trim bits. In production settings these new bits will run cooler and the edges will stay sharper, last longer and increase your shop productivity.

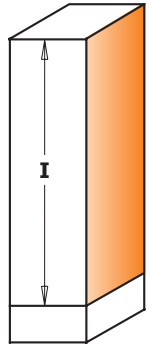
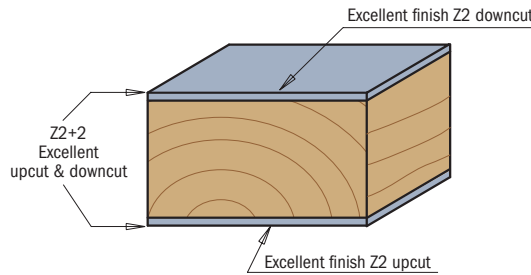

Drawing is 1:1 scale

I mm	D mm	L mm	ORDER NO. S=Ø6mm	ORDER NO. S=Ø6,35mm	ORDER NO. S=Ø12mm	ORDER NO. S=Ø12,7mm	Spare parts	
Z2+2 upcut & downcut spiral bit								
42	12,7	114			190.127.11B	190.508.11B	791.010.00	541.301.00
Z2 upcut spiral bit								
25,4	6,35	76,2	191.064.11B	191.008.11B			791.035.00	541.350.00
31,7	12,7	89				191.505.11B	791.010.00	541.301.00
50,8	12,7	114			191.127.11B	191.507.11B	791.010.00	541.301.00
Z2 downcut spiral bit								
31,7	12,7	89				192.505.11B	791.010.00	541.301.00
50,8	12,7	114			192.127.11B	192.507.11B	791.010.00	541.301.00

3 in 1 flush trim bits for MDF/laminate

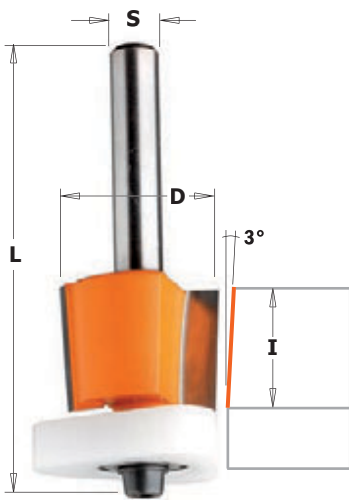

7/8/907



3 in 1 new flush trim bits with Delrin® Triangular bearings are your best partner for laminate trimming. In fact it solves 3 of the most common problems that occur in flush trimming in cabinet shops:

- 1) The anti-stick properties of the Delrin® bearing greatly reduces the likelihood of freezing of the bearing from glue.
- 2) The extended guide surface of the new Delrin® bearing will perfectly match the work surface without scratching like the steel bearing would. The Delrin® bearing also guarantees maximum stability.
- 3) The shear angle cutting edge reduces the need for filing. 3 in 1 bits are ideal on plastic laminates as well as aluminium laminates!

3 in 1 bits are ideal on plastic laminates as well as aluminium laminates!

Patent pending

- Extended guide surface
- Non-freezing
- Non-scratch surface

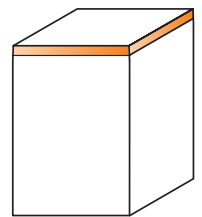
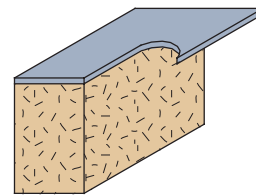

Drawing is 1:1 scale

Perfect trimming with the conical edges!

Thanks to the innovative conical edges of this bit you will always get perfect cuts even after re-sharpening. In fact, the most popular problem you have with the standard flush trim bits is the undersize diameter after re-sharpening which leaves the mark on the material; now with the new CMT construction you could re-sharpen up to six times without any problem. Just remember to adjust your bit up or down as per the illustration.

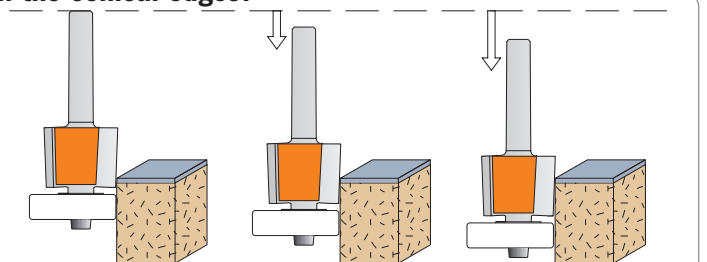

Spare parts

I mm	D mm	L mm	ORDER NO. S=Ø6mm	ORDER NO. S=Ø6,35mm	ORDER NO. S=Ø8mm	ORDER NO. S=Ø12,7mm	Spare parts			
12,7	12,7	54,2	707.128.11	807.128.11	907.128.11					
15,87	19	59,3	707.190.11	807.190.11	907.190.11		990.422.00	791.042.00	990.058.00	991.057.00
15,87	19	65,7				807.690.11	990.423.00	791.043.00	990.058.00	991.057.00
							990.423.00	791.043.00	990.058.00	991.057.00

Flush trim bits with insert knives



657.1

Flush trim bits with two replaceable knives fixed by special Torx screws. The blades are 2 sided sharpened and can give extra new edges. Guided flush trim bits type 657 are equipped with the ball bearing guides.

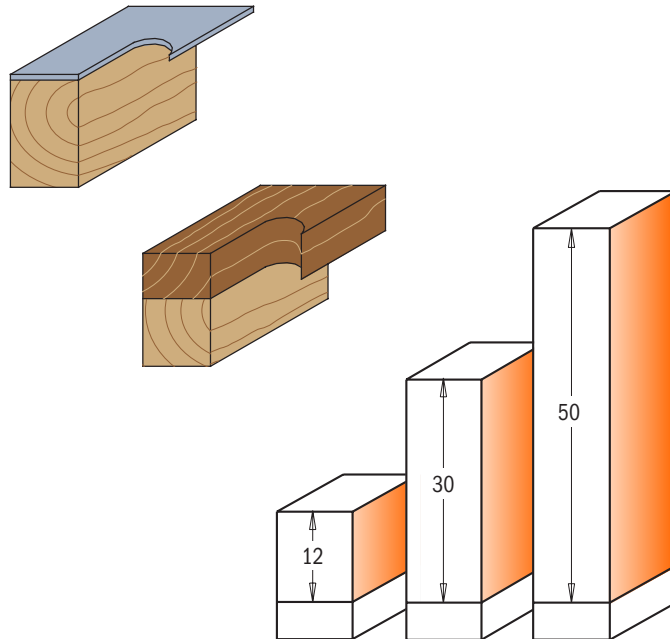

Drawings are 1:1 scale

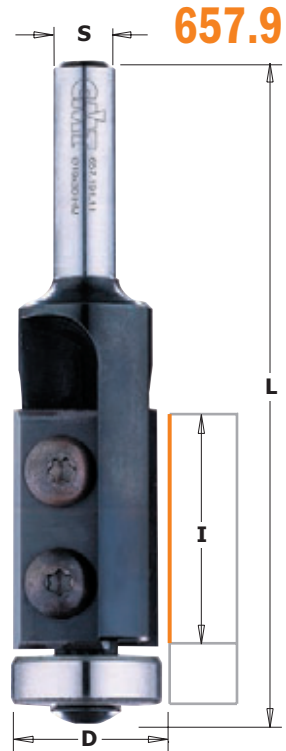

657.9

I mm	D mm	L mm	ORDER NO. S=Ø6mm	ORDER NO. S=Ø6,35mm	ORDER NO. S=Ø8mm	ORDER NO. S=Ø12 mm	ORDER NO. S=Ø12,7mm
12	19	56	657.194.11	657.192.11	657.190.11		
30	19	74	657.195.11		657.191.11		
30	19	87				657.692.11	
50	19	112				657.991.11	657.992.11

Spare parts

790.120.00	990.075.00	991.061.00	791.007.00
790.300.00	990.075.00	991.061.00	791.007.00
790.300.00	990.075.00	991.061.00	791.007.00
790.500.00	990.075.00	991.061.00	791.007.00

Spare parts

- 990.410.00 Ø4,2/Ø9mm shield for M4 screws
- 990.052.00 M4x6mm TCEI screws
- 991.067.00 3mm hex key
- 541.514.00 Ø6,4mm shield

FILE-FREE Flush trim bits for laminate

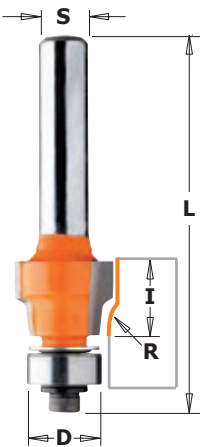

8/907

This new CMT's bit is perfect for ensuring smooth flawless results on your laminate surfaces after flush trimming. Sharp edges are easily trimmed away, leaving your surfaces nice and smooth to the touch. No further filing is needed!

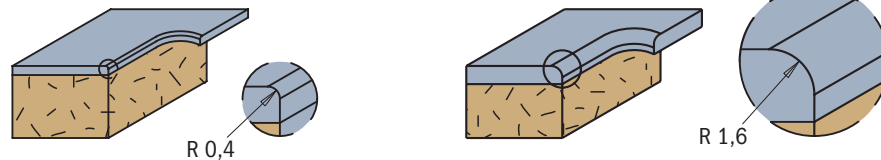

Drawings are 1:1 scale

D mm	I mm	R mm	L mm	ORDER NO. S=Ø6,35mm	ORDER NO. S=Ø8mm
12,7	9,5	0,4	52	807.004.11	907.004.11
12,7	9,5	1,6	52	807.015.11	907.015.11

Spare parts

990.422.00	791.002.00	990.058.00	991.057.00
990.422.00	791.002.00	990.058.00	991.057.00

Pattern/Flush trim bits with insert knives

Saw blades

Jig saw blades

Tools with bore & Knives

Router bits & sets

CNC router cutter & chucks

Industrial dowel drills

Bits for hand power tools

Power tools & accessories

Display cabinets & spare parts



657B

Flush trim bit combined with pattern bit fixed by special Torx screws. The blades are 2 sided sharpened and can give extra new edges. Guided flush trim bits type 657 are equipped with the top and bottom ball bearing guides. For flush and finishing operations.

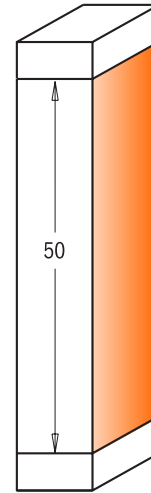
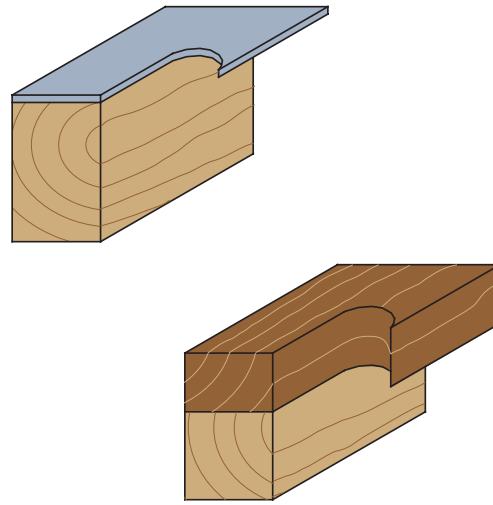

Drawing is 1:1 scale

I mm	D mm	L mm	ORDER NO. S=Ø12mm	ORDER NO. S=Ø12,7mm
50	19	110	657.993.11B	
50	19	110		657.994.11B

Spare parts

790.500.00	990.075.00	791.007.00	990.052.00	791.011.00	541.002.00
790.500.00	990.075.00	791.007.00	990.052.00	791.011.00	541.002.00

Spare parts
 990.410.00 Ø4,2/Ø9mm shield for M4 screws
 991.067.00 3mm hex key

991.061.00 T15 Torx key
 991.056.00 1,5mm hex key

Flush trim router bits with double bearing



806/906B

These new innovative two-flute router bits are equipped with a double bearing and feature a down shear design, which allows for clean smooth cuts on many materials. Therefore it is no longer necessary to flip or move your tool if you need to ride it from either direction to the other side of your workpiece. You will benefit from this tool especially when routing curved elements along or against the grain.

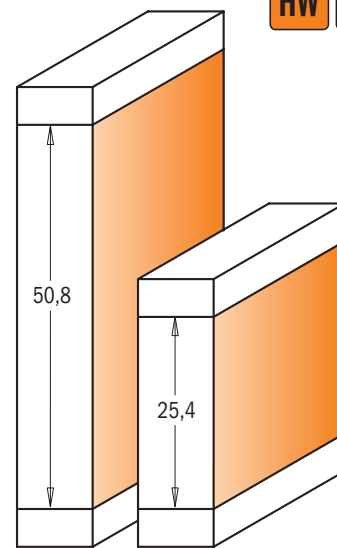

Drawings are 1:1 scale

I mm	D mm	L mm	ORDER NO. S=Ø12mm	ORDER NO. S=Ø12,7mm
25,4	19	86,5	906.691.11B	
25,4	19	86,5		806.691.11B
50,8	19	109,5	906.690.11B	
50,8	19	109,5		806.690.11B

Spare parts

791.004.00	541.550.00	990.058.00	791.011.00	541.005.00
791.004.00	541.550.00	990.058.00	791.011.00	541.002.00
791.004.00	541.550.00	990.058.00	791.011.00	541.005.00
791.004.00	541.550.00	990.058.00	791.011.00	541.002.00

Panel pilot bits with guide

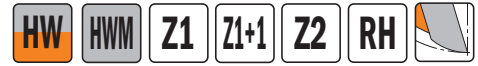

7/8/916

How much time do you end up spending making openings in paneling, drywall, siding, doors or windows? With the CMT panel pilot bit, the job just got quicker. The point plunges smoothly and easily and the carbide edges cut clean and fast. All of this adds up to accurate cuts in less time and with less effort - great for trimming formica, veneer and other laminates.

SAFETY TIPS: Always use extra caution when working near electrical outlets and boxes - always disconnect the current. Make sure the bit does not go so deep as to cut the wires.

716.061

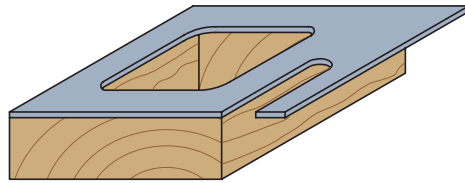
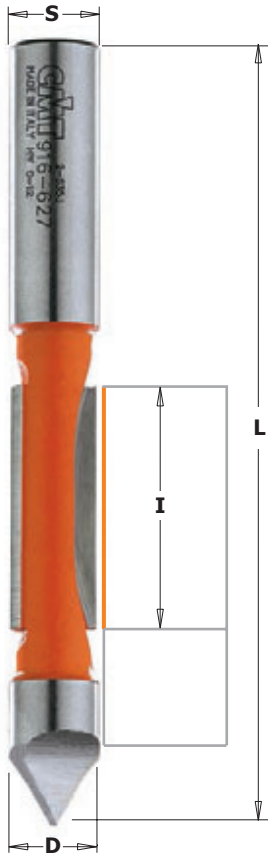

A unique and time saving bit, the CMT Double Panel Pilot Bit is perfect for making openings and slots in veneers and laminates. The lower portion of the cutting edge is located under the bearing and allows you to cut on both sides of the material. Durable carbide tipped cutters are spaced 12mm apart and each cutter can work in stock up to 18mm thick.

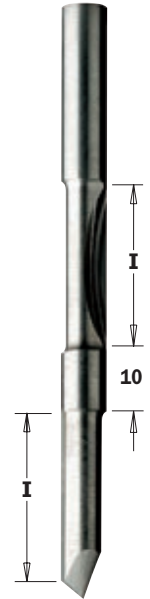
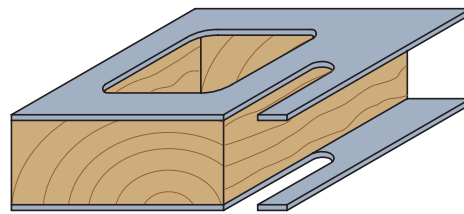

• HWM

D mm	I mm	L mm	Z	ORDER NO. S=Ø6mm	ORDER NO. S=Ø6,35mm	ORDER NO. S=Ø8mm	ORDER NO. S=Ø12mm	ORDER NO. S=Ø12,7mm
6	19	64	1	716.060.11				
•6	19	60	1	716.060.21				
•6	18+18	70	1+1	716.061.11				
6,35	19	64	1		816.064.11			
8	19	64	1			916.080.11		
9,53	25,4	78	2		816.095.11			
12	31,7	102	2				916.627.11	
12,7	31,7	102	2					816.627.11
10 pcs. in masterpack								
12,7	31,7	102	2					816.627.11-X10

Panel pilot bits with guide

7/8/953



An absolutely indispensable bit for making cabinets. CMT Flush and V-Groove bits allow you to make cabinet front frames in 25mm stock that fit perfectly with the sides. The added V-cutter feature makes a decorative groove along the hinge joint to hide the seam.

SHOP TIP: For best results, leave less than 3mm overhang on cabinet front frames for easier routing.

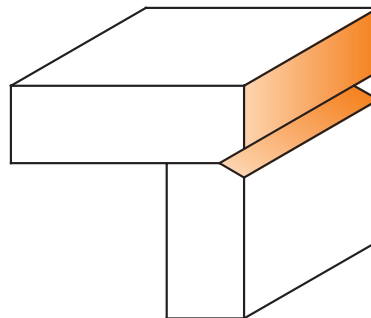
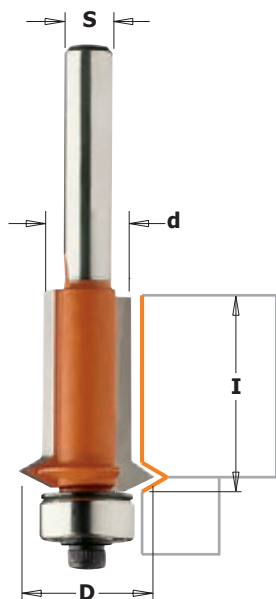

Drawing is 1:1 scale

d mm	D mm	I mm	ORDER NO. S=Ø6mm	ORDER NO. S=Ø6,35mm	ORDER NO. S=Ø8mm	ORDER NO. S=Ø12mm	ORDER NO. S=Ø12,7mm	Spare parts			
12,7	19	25,4	753.001.11	853.001.11	953.001.11	953.501.11	853.501.11				
								990.423.00	791.003.00	990.058.00	991.057.00

The CMT grand rabet set



8/935.503

Your choice of "The Grand Rabet" by CMT is an investment that shows your commitment to quality. This CMT product will deliver years of reliable service under normal use. For safe and trouble-free results please observe the following instructions and safety precautions.

The complete kit (item code 835-935.503.11), will enable you to produce 17 different rabet sizes including rabbets for under-size plywood applications.

For rabet sizes over 12,7mm (1/2"), make the cuts in several shallow passes until the desired depth is achieved.

Available in 12 and 12,7mm shanks.

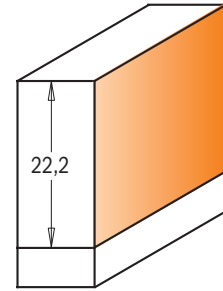
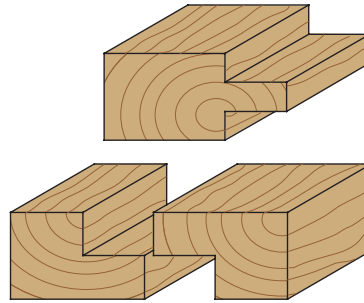

Collar order no.
799.517.00

8/935.990



Drawings are 1:1 scale

Order no. 791.705.00

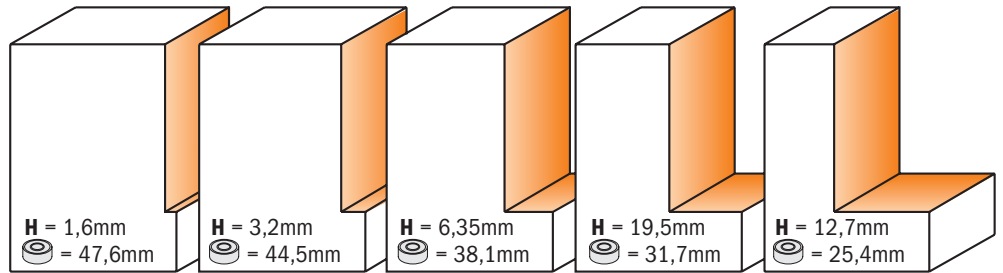

Order no. 791.706.00

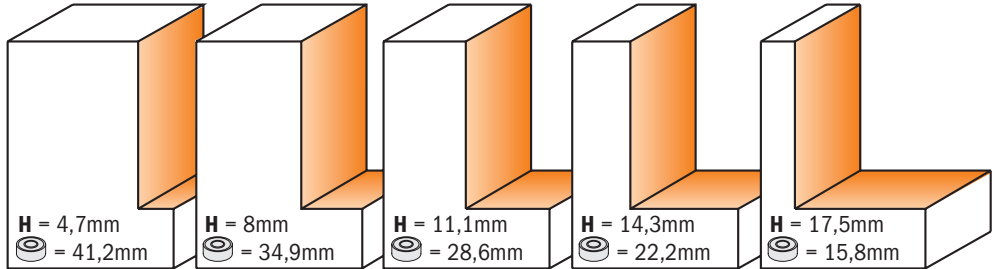
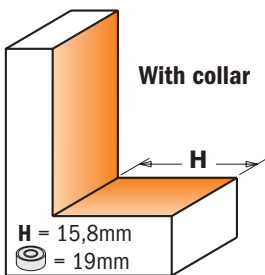

Order no. 791.707.00

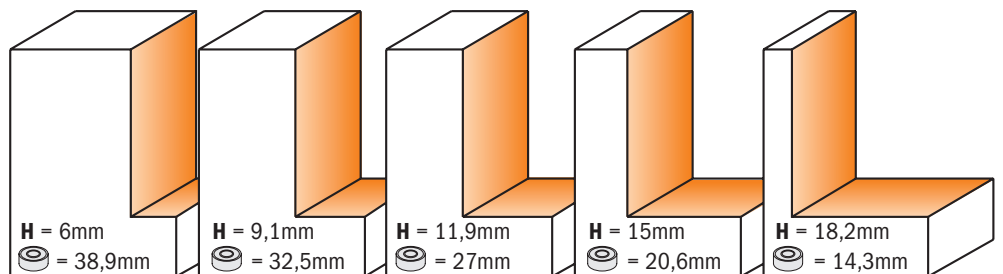
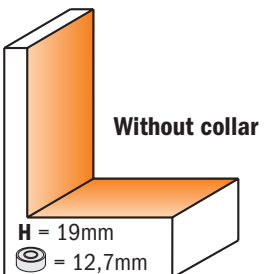

DESCRIPTION	ORDER NO. S=Ø12mm	ORDER NO. S=Ø12,7mm
The CMT grand rabet set (Ø50,8x22,2mm)	935.503.11	835.503.11

SET CONTAINS: The grand rabet (bit only) with collar Ø19mm	935.990.11	835.990.11
5 pcs. collar set (1,6 - 3,2 - 6,35 - 9,5 - 12,7mm rabbets)		791.705.00
5 pcs. collar set (4,7 - 8 - 11,1 - 14,3 - 17,5mm rabbets)		791.706.00
5 pcs. collar set (6 - 9,1 - 11,9 - 15 - 18,2mm rabbets)		791.707.00
Collar Ø50,8mm		799.517.00
Kit with screw, shields and keys		990.452.00

Rabbeting bits

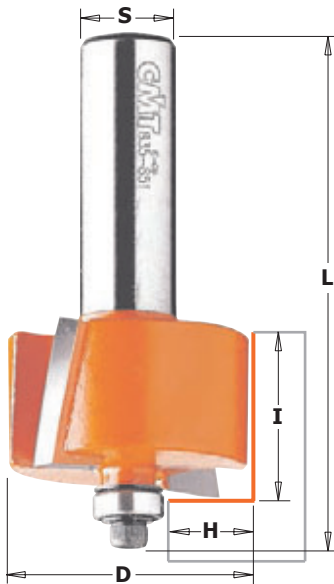

7/8/935

CMT carbide-faced rabbeting bits are fast and accurate - you can quickly produce inset doors and drawer fronts, make strong rabbet joints, mill perfect tongue and groove joints or any number of other jobs that before were time consuming and difficult. You can even re-groove old window frames to fit insulated glass panes with the extra long CMT 19mm (3/4") rabbeting bit. Other possibilities are illustrated below and on the following pages. Look at our slot cutters and round over bits for ideas on how to put extra finishing touches on all your grooving and rabbeting projects.

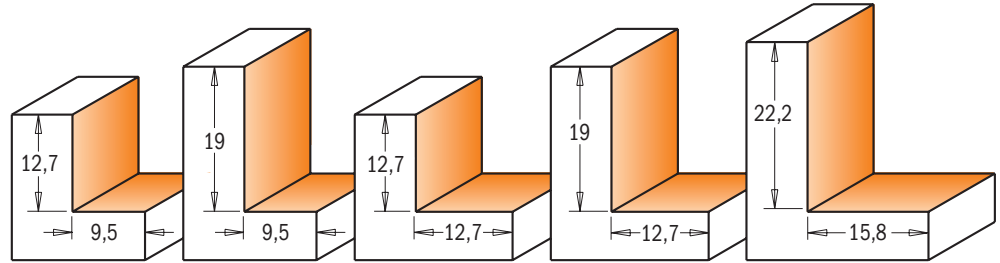

Drawings are 1:1 scale

H mm	D mm	I mm	L mm	ORDER NO. S=Ø6mm	ORDER NO. S=Ø6,35mm	ORDER NO. S=Ø8mm	ORDER NO. S=Ø12mm	ORDER NO. S=Ø12,7mm	Spare parts		
9,5	31,7	12,7	58,4	735.317.11	835.317.11	935.317.11					
9,5	31,7	12,7	61,2				935.817.11	835.817.11	990.423.00	791.003.00	990.058.00
9,5	31,7	19	64,8	735.318.11		935.318.11			990.423.00	791.003.00	990.058.00
12,7	34,9	12,7	59,4	735.350.11	835.350.11	935.350.11	935.850.11	835.850.11	990.422.00	791.002.00	990.058.00
12,7	34,9	19	65,8				935.851.11	835.851.11	990.422.00	791.002.00	990.058.00
16	50,8	22	77,8				935.990.11	835.990.11	990.408.00	791.010.00	990.058.00

Spare parts 991.057.00 3/32" hex key
799.503.00 19,05mm bushings

541.514.00 2mm spacer (8/935.990.11)

Rabbeting sets

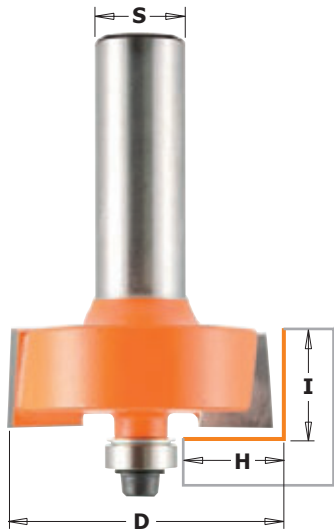

7/8/935.001

CMT rabbeting sets allow you to make a limitless number of cuts by adjusting the cutting height on your router and changing the bearing on the bit.



BE SURE to keep the black bearing washer right side up to correspond with the bearing rotation when re-assembling the bearing. Improper re-assembly can cause the screw to come loose. Each set comes complete with one rabbeting bit and six interchangeable ball bearing guides.

Drawings are 1:1 scale

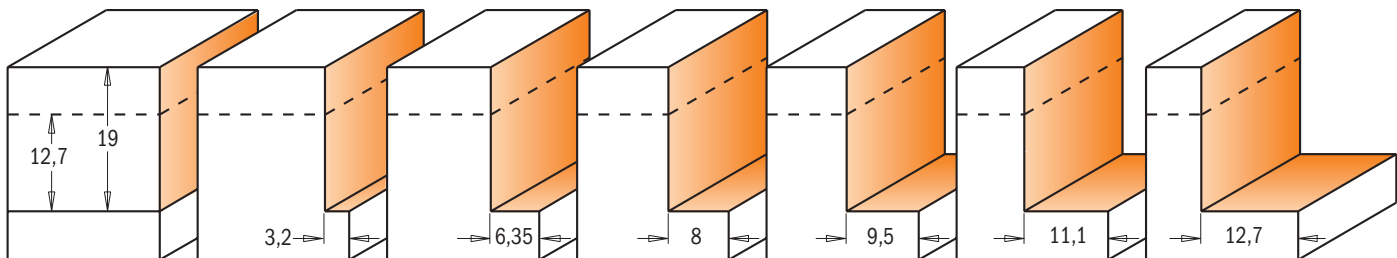

H mm	D mm	I mm	ORDER NO. S=Ø6mm	ORDER NO. S=Ø6,35mm	ORDER NO. S=Ø8mm	ORDER NO. S=Ø12mm	ORDER NO. S=Ø12,7mm
0-12,7	34,9	12,7	735.001.11	835.001.11	935.001.11	935.501.11	835.501.11
0-12,7	34,9	19				935.502.11	835.502.11

Rabbeting bits with insert knives

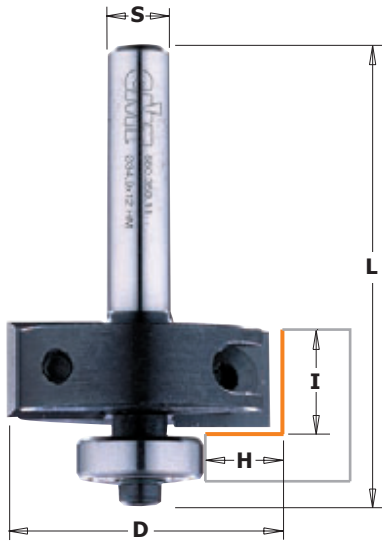

660

Rabbeting bits with two replaceable knives fixed by special Torx screws. The blades are 4 sided sharpened and gives high economy of your work with board materials. Rabbeting bits are equipped with the ball bearing guides for rabbeting width H= 9,5mm. Optionals you can choose bearings for rabbeting width 12,7 - 11,1 - 8 - 6,35 - 3,2 - 0mm. For chipboards, hard wood or MDF. For use on portable Routers.

Drawings are 1:1 scale

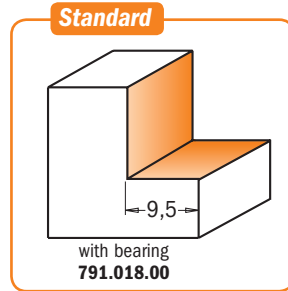

Optional

with bearing 791.016.00 with bearing 791.014.00 with bearing 791.017.00
 with bearing 791.019.00 with bearing 791.003.00 with bearing 791.002.00

Spare parts 990.463.00 Kit with screw, shield and key

H mm	D mm	I mm	L mm	ORDER NO. S=Ø6,35mm	ORDER NO. S=Ø8mm	ORDER NO. S=Ø12,7mm	Spare parts							
9,5	34,9	12	55	660.351.11	660.350.11						790.120.00	990.075.00	991.061.00	791.018.00
9,5	34,9	12	65			660.851.11					790.120.00	990.075.00	991.061.00	791.018.00

Spare parts 990.400.00 Ø3.2/Ø7mm shield for M3 screw
 541.552.00 Ø3.25/Ø15.8mm shield for M3 screw
 990.051.00 M3x6mm TCEI screws

990.053.00 M3x10mm TCEI screws
 990.054.00 M3x16mm TCEI screws
 991.062.00 Hex key 2,5mm

Grand rabbeting bits with insert knives

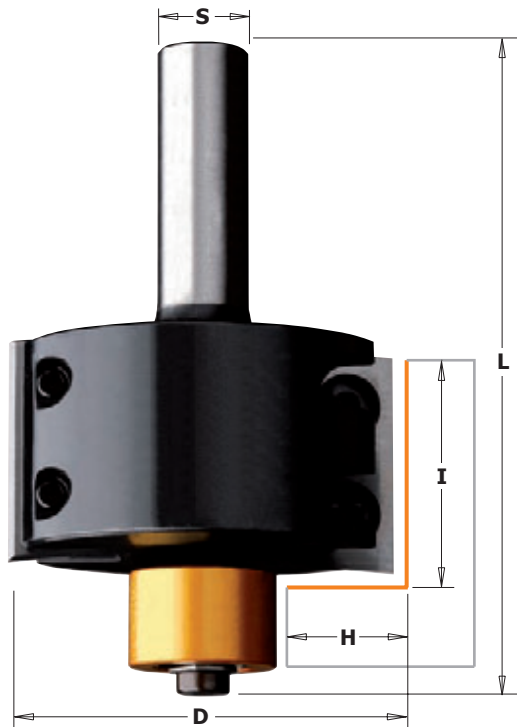

660.9

Your choice of "The Grand Rabbet" by CMT is an investment that shows your commitment to quality. This CMT product will deliver years of reliable service under normal use. The collar sets (791.705.00-791.706.00-791.707.00) will enable you to produce 17 different rabbet sizes including rabbets for under-size plywood applications. For rabbet sizes over 12,7mm (1/2"), make the cuts in several shallow passes until the desired depth is achieved. Available in 12 and 12,7mm shanks.

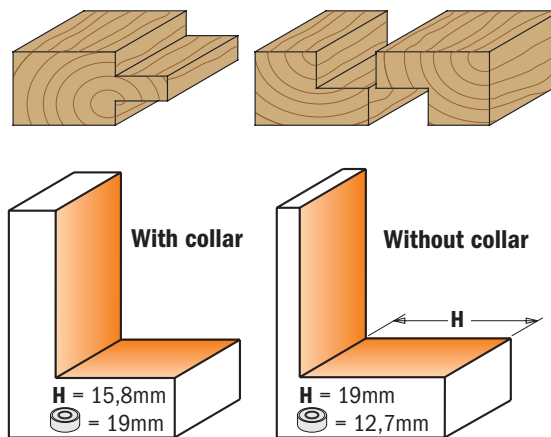

Collar order no. 799.517.00

Drawing is 1:1 scale

H mm	D mm	I mm	L mm	ORDER NO. S=Ø12mm	ORDER NO. S=Ø12,7mm	Spare parts							
16	50,8	28,3	87,3	660.990.11	660.991.11					790.283.12	990.075.00	991.061.00	791.010.00

Spare parts 541.514.00 Ø6,4mm stop collar
 799.503.00 Ø19,05mm bushings
 990.410.00 Ø4.2/Ø9mm shield for M4 screw
 990.052.00 M4x6mm TCEI screw
 991.067.00 3mm hex key
 990.469.00 Kit screw, shield and key

Optional: 799.517.00 Collar for flush trim Ø50,8mm
 791.705.00 5 pcs. collar set (1,6-3,2-6,35-9,5-12,7mm rabbets)
 791.706.00 5 pcs. collar set (4,7-8-11,1-14,3-17,5mm rabbets)
 791.707.00 5 pcs. collar set (6-9,1-11,9-15-18,2mm rabbets)

Saw blades
 Jig saw blades
 Tools with bore & Knives
 Router bits & sets
 CNC router cutter & chucks
 Industrial dowel drills
 Bits for hand power tools
 Power tools & accessories
 Display cabinets & spare parts

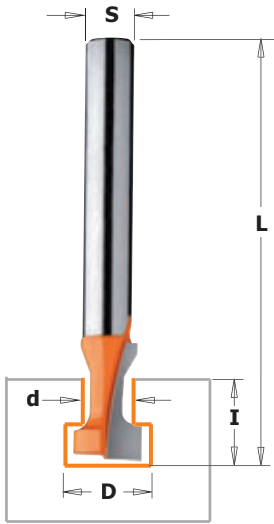

7/8/950.001



With the CMT keyhole bit you can make holes that keep your frames, plaques or any wall hanging perfectly straight and attached to the wall. The bit bores an entry hole in the wood, then proceeds to cut a 4,8mm hole and finishes by boring a larger opening under the surface. The perfect way to securely mount wall hangings on screws and nails.

SAFETY TIPS: Be sure the workpiece is securely fastened to the router table or work bench.

SHOP TIPS: Recommended for use with a plunge router.

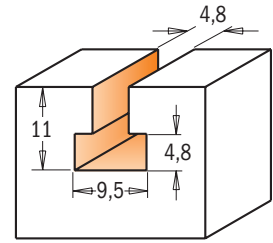
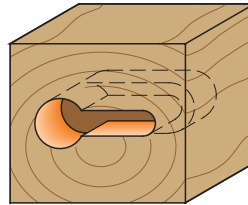
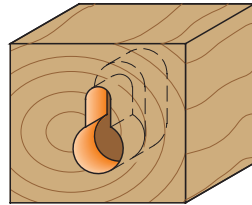

Drawing is 1:1 scale

D mm	d mm	I mm	L mm	ORDER NO. S=Ø6mm	ORDER NO. S=Ø6,35mm	ORDER NO. S=Ø8mm	ORDER NO. S=Ø12mm	ORDER NO. S=Ø12,7mm
9,5	4,8	11	54	750.001.11	850.001.11	950.001.11	950.501.11	850.501.11

T-Slot bits

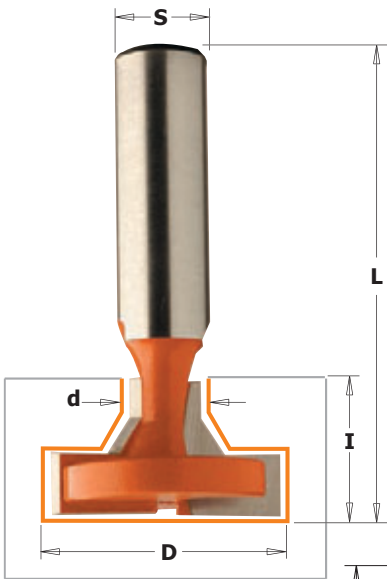

8/950.6

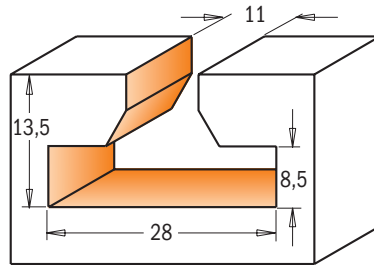

8/950.603

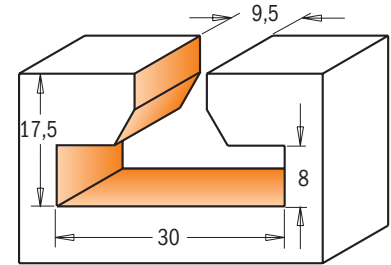

8/950.601

Drawings are 1:1 scale

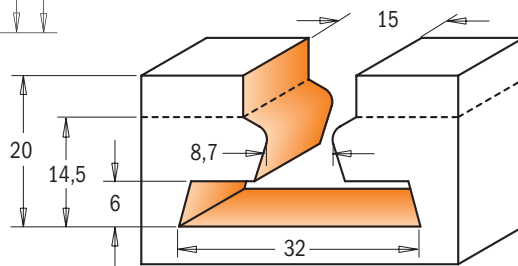

950.604

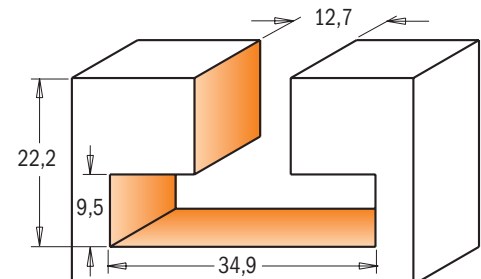

8/950.602

D mm	d mm	I mm	L mm	Z	ORDER NO. S=Ø12mm	ORDER NO. S=Ø12,7mm
28	11	13,5	56,3	2	950.603.11	850.603.11
30	9,5	17,5	60,3	2	950.601.11	850.601.11
32	8,7-15	20	66	1+1	950.604.11	
34,9	12,7	22,2	63,5	2	950.602.11	850.602.11

Screw slot bits



8/913

Any large panel or table top should be secured in a way that allows it to expand or contract without splitting. These screw-slot bits let you create screw slots so that panels can be held in place but are able to slide back and forth without splitting the wood or breaking the screw securing them.

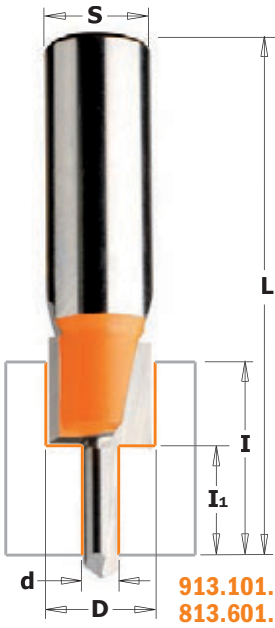

913.101.11
813.601.11

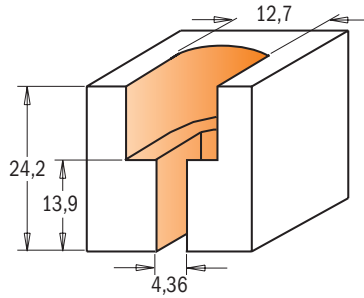

Drawing is 1:1 scale

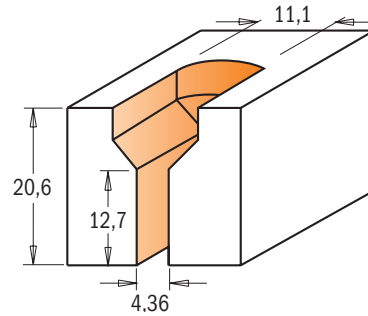

913.201.11
813.701.11

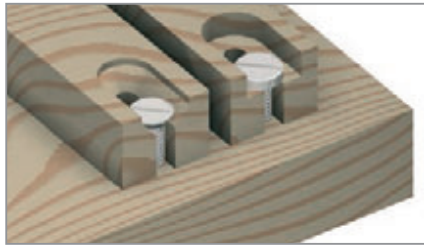

D mm	d mm	I ₁ mm	I mm	L mm	ORDER NO. S=Ø8mm	ORDER NO. S=Ø12,7mm
11,1	4,36	12,7	20,6	63,5	913.201.11	813.701.11
12,7	4,36	13,9	24,2	63,5	913.101.11	813.601.11

Flooring router bits



822.023B - 822.024B

CMT now offers these industrial quality carbide-tipped router bits for flooring and inlay applications. They can easily and smoothly run through solid and timber wood while cutting edges keep sharp still after several passes. 822.024.11B item number also features rounded edges to produce 3,2mm (1/8") radius inlays. These bits are equipped with a stop collar and a bearing.

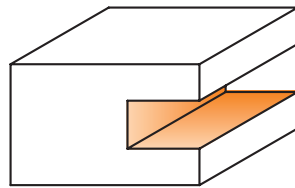
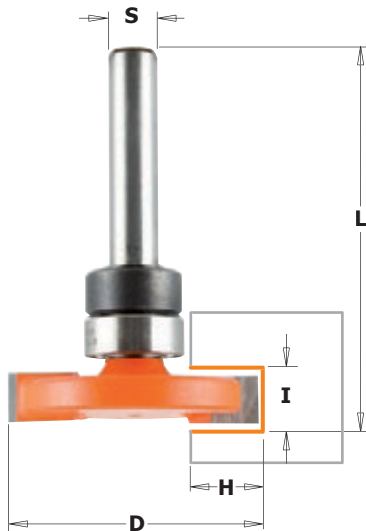

Drawings are 1:1 scale

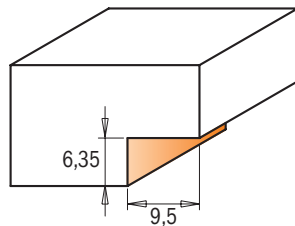

822.023.11B

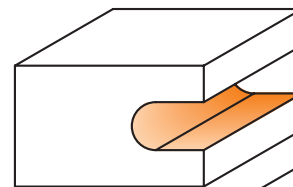

822.024.11B

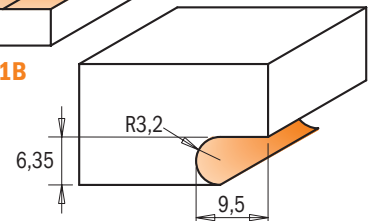

D mm	I mm	H mm	R mm	L mm	ORDER NO. S=Ø6,35mm
31,75	6,35	9,5		47,6	822.023.11B
31,75	6,35	9,5	3,2	47,6	822.024.11B

Spare parts

791.010.00	541.001.00	990.005.00	991.056.00
791.010.00	541.001.00	990.005.00	991.056.00

Saw blades
Jig saw blades
Tools with bore & Knives
Router bits & sets
CNC router cutter & chucks
Industrial dowel drills
Bits for hand power tools
Power tools & accessories
Display cabinets & spare parts

Three wing slot cutter set

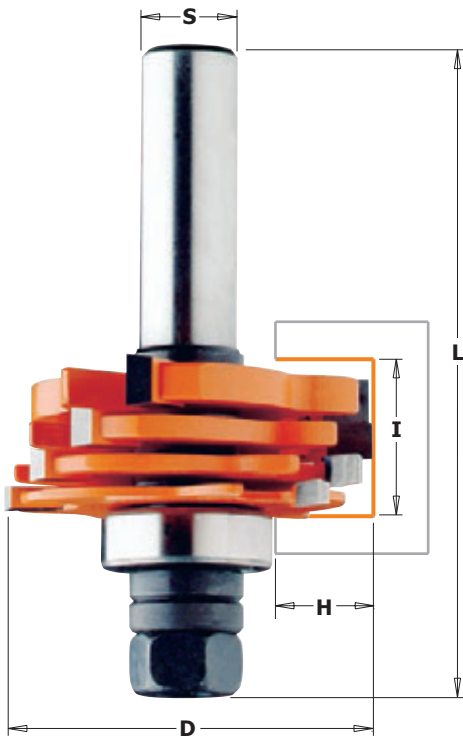

8/900.506

Create slots, grooves and rabbets in materials from 3,2mm to 18mm in depth by using the adjustable CMT Three Wing slot cutter set. See chart below for details on spacing and correct cutter combinations. Ideal for biscuit joints and milling perfect tongue and groove joints.

This set includes:

- 4 carbide tipped cutters 3,2mm, 4mm, 4,8mm, 6,4mm
- 1 arbor 12mm or 12,7mm
- 1 ball bearing (22mm) for 12,7mm cut
- 17 shims: (8x0,1mm - 4x0,5mm - 3x1mm and 2x4mm)

Safety tips: Never use the slot cutter set without shims between the cutters.

The distance between the cutters can vary from 1mm to 1,7mm. A shim must also be positioned between the ball bearing and the cutters.

Shop tips: The bearings kit 791.711.00 allows to make 6,35 and 9,5mm cutting depth.

NOTE: The carbide edges of the cutters should never touch; arrange the shims as illustrated below. Use only the thicknesses provided in the set. Be sure all cutters are assembled in the proper right rotational direction below. Looking down the arbor the cutters will turn clockwise.

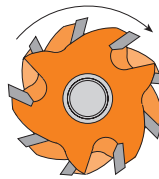

Cutter combinations	Cutter height mm	mm
A	3,2	
B	4	
C	4,8	
D	6,4	
A + B	6,4	a 7,1
A + C	7,2	a 7,9
A + D	8,8	a 9,5
B + C	8	a 8,7
B + D	9,6	a 10,3
C + D	10,4	a 11,1
A + B + C	10,4	a 11,8
A + B + D	11,9	a 13,3
A + C + D	12,7	a 14,1
B + C + D	13,5	a 14,9
A + B + C + D	15,9	a 18

Use shims to adjust cut width: MIN.1mm - MAX 1,7mm

I mm	D mm	H mm	L mm	ORDER NO. S=Ø12mm	ORDER NO. S=Ø12,7mm	Spare parts
3,2-18	47,6	12,8	81	900.506.11		924.128.00 791.005.00 990.020.00
3,2-18	47,6	12,8	81		800.506.11	824.128.00 791.005.00 990.020.00

Spare parts
 541.515.00 0,1mm spacer
 541.517.00 0,5mm spacer
 541.518.00 1mm spacer
 541.501.00 4mm spacer

Optional:
 791.711.00 Kit of two bearing 28,5mm and 34,9mm for slot cutter

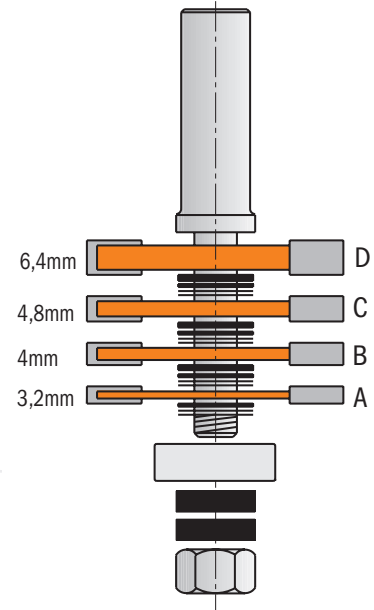

Tongue and groove set

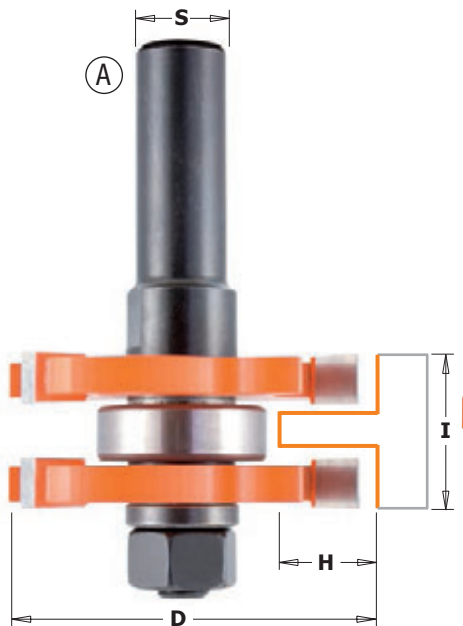

8/900.626

Make tongue and groove joints without the complicated process of taking apart and reassembling bits. The new CMT tongue and groove set gives you one bit to groove the slot and a separate bit to mill the tongue. Or use your imagination and put them to work individually on other projects. Makes tongue and groove cuts in wood up to 19mm thick.



Drawings are 1:1 scale

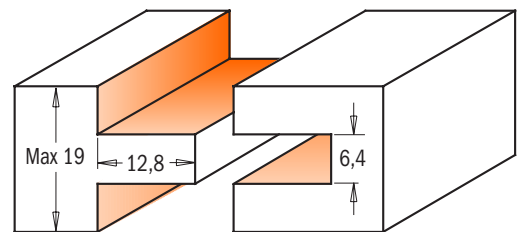

Profile	I mm	D mm	H mm	L mm	ORDER NO. S=Ø8mm	ORDER NO. S=Ø12mm	ORDER NO. S=Ø12,7mm	Spare parts
A+B	19	47,6	12,8	71	900.126.11			924.083.00 791.005.00 822.364.11 990.020.00
A+B	19	47,6	12,8	71		900.626.11		924.131.00 791.005.00 822.364.11 990.020.00
A+B	19	47,6	12,8	71			800.626.11	824.131.00 791.005.00 822.364.11 990.020.00
A	19	47,6	12,8	71			800.626.11M	824.131.00 791.005.00 822.364.11 990.020.00

Spare parts
 541.515.00 0,1mm spacer
 541.516.00 0,3mm spacer
 541.517.00 0,5mm spacer

541.518.00 1mm spacer
 541.500.00 3mm spacer

Slot cutters



7/8/922A/B

Uses for the CMT three wing slot cutter are almost infinite. Cut slots and grooves for splines, biscuits, T-molding or tongue and groove joints. Every cutter features anti-kickback design, micrograin carbide tips and orange CMT trademark non-stick PTFE coating. CMT slot cutters are available as a blade only or with your choice of a 6, 8, 12, 6,35 or 12,7mm diameter arbor which includes a 22mm diameter bearing for a cutting depth of up to 12,7mm.

NOTE: For biscuit joints, use l=4mm slot cutter.

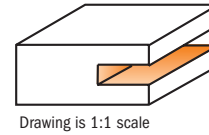
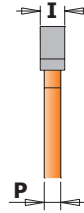
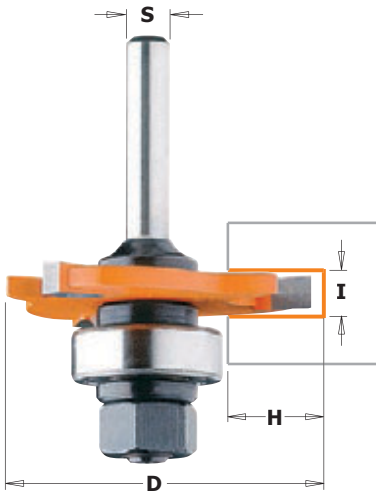

I mm	P mm	D mm	H mm	ORDER NO. S=Ø6mm	ORDER NO. S=Ø6,35mm	ORDER NO. S=Ø8mm	ORDER NO. S=Ø12mm	ORDER NO. S=Ø12,7mm
1,5	1,07	47,6	12,8	722.315.11A		922.315.11A	922.315.11B	
1,6	1,07	47,6	12,8		822.316.11A			822.316.11B
2	1,27	47,6	12,8	722.320.11A	822.320.11A	922.320.11A	922.320.11B	822.320.11B
2,4	1,27	47,6	12,8		822.324.11A			822.324.11B
2,5	1,27	47,6	12,8	722.325.11A		922.325.11A	922.325.11B	
3	1,27	47,6	12,8	722.330.11A		922.330.11A	922.330.11B	
3,2	1,27	47,6	12,8		822.332.11A			822.332.11B
3,5	2,07	47,6	12,8	722.335.11A		922.335.11A	922.335.11B	
4	2,07	47,6	12,8	722.340.11A	822.340.11A	922.340.11A	922.340.11B	822.340.11B
4,8	2,86	47,6	12,8		822.348.11A			822.348.11B
5	2,86	47,6	12,8	722.350.11A		922.350.11A	922.350.11B	
6	4,45	47,6	12,8	722.360.11A	822.360.11A	922.360.11A	922.360.11B	822.360.11B
6,4	4,45	47,6	12,8		822.364.11A			822.364.11B

These three wing carbide tipped Slot Cutters feature anti-kickback three wing blade design and CMT's trademark orange P.T.F.E. Industrial Coating. All cutters feature an 8mm bore that fits CMT's arbors (items 7/8/924).

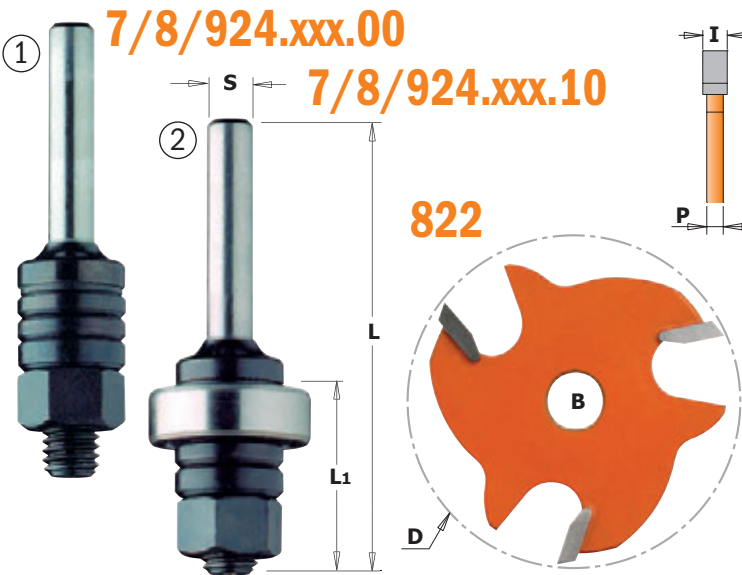

I mm	P mm	D mm	B mm	ORDER NO.
1,5	1,07	47,6	8	822.315.11
1,6	1,07	47,6	8	822.316.11
1,8	1,27	47,6	8	822.318.11
2	1,27	47,6	8	822.320.11
2,2	1,27	47,6	8	822.322.11
2,4	1,27	47,6	8	822.324.11
2,5	1,27	47,6	8	822.325.11
2,8	1,27	47,6	8	822.328.11
3	1,27	47,6	8	822.330.11
3,2	1,27	47,6	8	822.332.11
3,5	2,07	47,6	8	822.335.11
4	2,07	47,6	8	822.340.11
4,8	2,86	47,6	8	822.348.11
5	2,86	47,6	8	822.350.11
6	4,45	47,6	8	822.360.11
6,4	4,45	47,6	8	822.364.11

DESCRIPTION	L1 mm	L mm	ORDER NO. S=Ø6mm	ORDER NO. S=Ø6,35mm	ORDER NO. S=Ø8mm	ORDER NO. S=Ø12mm	ORDER NO. S=Ø12,7mm
① Slot cutter arbor without bearing	26	61	724.060.00	824.064.00	924.080.00		
① Slot cutter arbor without bearing	26	67,5				924.120.00	824.127.00
② Slot cutter arbor with bearing	26	61	724.060.10	824.064.10	924.080.10		
② Slot cutter arbor with bearing	26	67,5				924.120.10	824.127.10
Slot cutter arbor without bearing, long series	40	86			924.083.00		
Slot cutter arbor with bearing, long series	40	86			924.083.10		

Spare parts

791.005.00	Ø8-22mm bearing	541.518.00	1mm spacer
541.501.00	4mm spacer	990.020.00	M8 nut
541.500.00	3mm spacer		

Saw blades
Jig saw blades
Tools with bore & Knives
Router bits & sets
CNC router cutter & chucks
Industrial dowel drills
Bits for hand power tools
Power tools & accessories
Display cabinets & spare parts



923A - 823B

The possible uses of this bit are almost: you can rout grooves and rabbets, T or dovetail joints on wood panels. Each bit has three carbide tipped cutters and has an orange coloured PTFE coating, it features anti-kickback design too. The 22mm bearing is included for a cutting depth of 12,8mm. The bit and the slot cutter are available also separately.

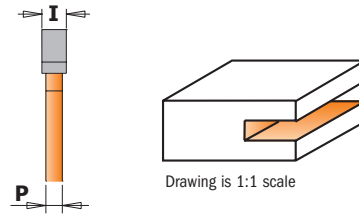
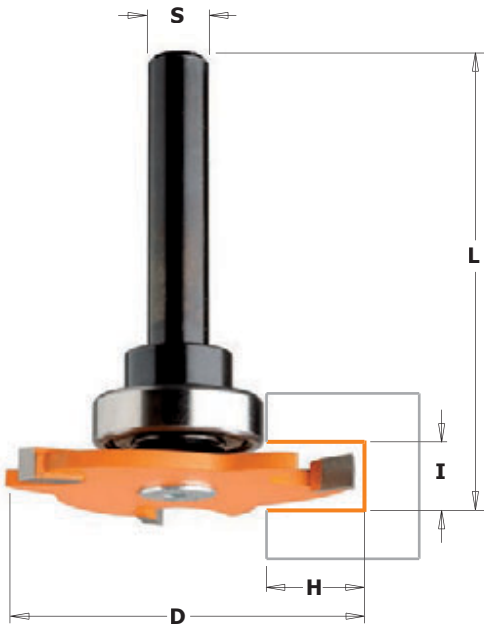

I mm	P mm	D mm	H mm	L mm	ORDER NO. S=Ø8mm	ORDER NO. S=Ø12,7mm
3	1,27	47,6	12,8	58	923.330.11A	
3,2	1,27	47,6	12,8	58,2		823.332.11B
4	2,07	47,6	12,8	58,4	923.340.11A	823.340.11B
5	2,86	47,6	12,8	63	923.350.11A	
6,4	4,45	47,6	12,8	64,4		823.364.11B

823

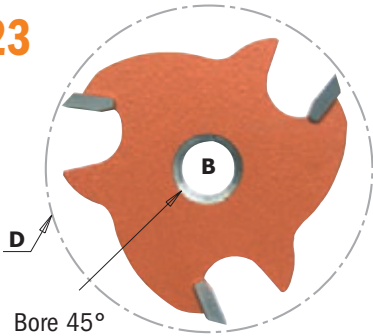

Bore 45°

These three wing carbide tipped slot cutters feature anti-kickback three wing blade design and CMT's trademark orange PTFE Industrial Coating. All cutters feature an 8mm bore that fits CMT's arbors (items 7/8/924).

I mm	P mm	D mm	B mm	ORDER NO.
3	1,27	47,6	8	823.330.11
3,2	1,27	47,6	8	823.332.11
4	2,07	47,6	8	823.340.11
5	2,86	47,6	8	823.350.11
6,4	4,45	47,6	8	823.364.11

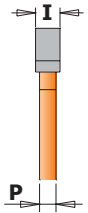

7/8/924

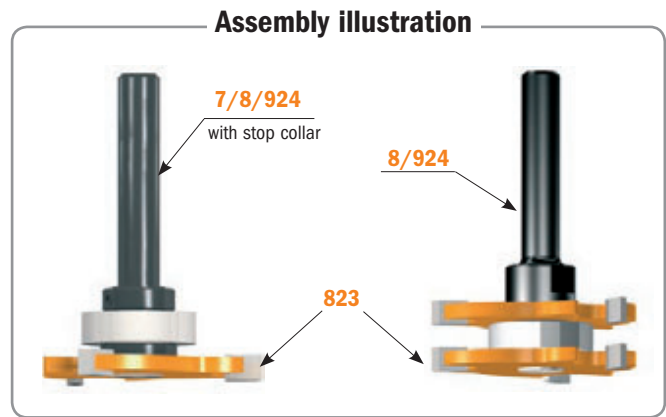
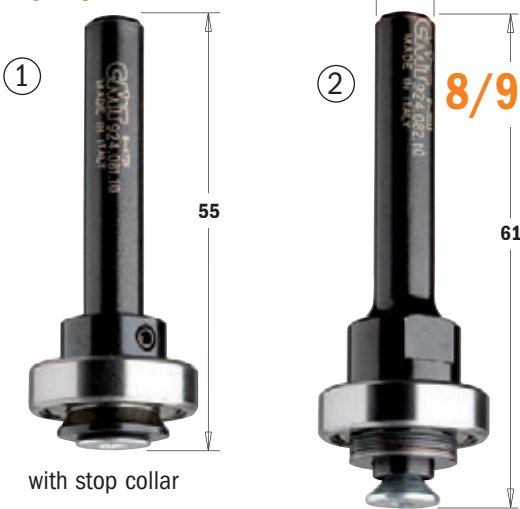

DESCRIPTION	ORDER NO. S=Ø6mm	ORDER NO. S=Ø6,35mm	ORDER NO. S=Ø8mm	ORDER NO. S=Ø12,7mm
① Slot cutter arbor without bearing without stop collar	724.061.00	824.061.00	924.081.00	824.121.00
① Slot cutter arbor with bearing and stop collar	724.061.10	824.061.10	924.081.10	824.121.10
② Slot cutter arbor without bearing			924.082.00	824.122.00
② Slot cutter arbor with bearing			924.082.10	824.122.10

Spare parts

791.012.00	Ø8-22mm bearing	541.515.00	0,1mm spacer
541.001.00	Stop collar for Ø6,35mm shanks	541.516.00	0,3mm spacer
541.002.00	Stop collar for Ø12,7mm shanks	541.517.00	0,5mm spacer
791.013.00	Ø12,7-22mm bearing	541.518.00	1mm spacer
541.003.00	Stop collar for Ø6mm shanks	990.055.00	M5x12mm TSPEI screw
541.004.00	Stop collar for Ø8mm shanks	991.067.00	3mm hex key

Flute & bead set

Saw blades

Jig saw blades

Tools with bore & Knives

Router bits & sets

CNC router cutter & chucks

Industrial dowel drills

Bits for hand power tools

Power tools & accessories

Display cabinets & spare parts



8/955.701

This perfectly mated CMT set is ideal for making canoe slats and hot tubs. Featuring tungsten carbide, the bits' cutting edges stay sharp after cutting large amounts of stock, and the anti-kickback design lets you work safely.

Use both the flute and the bead bits for 6,35mm (1/4") slats as shown below.

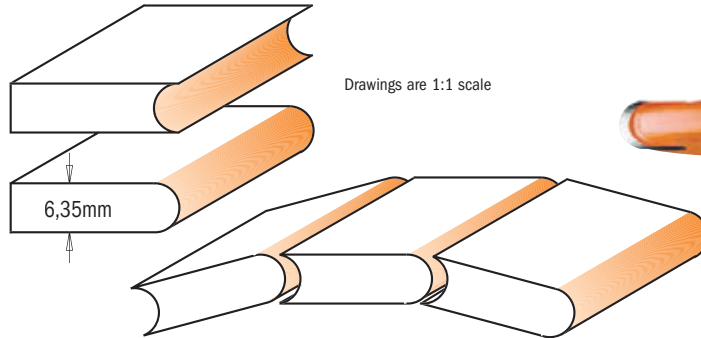
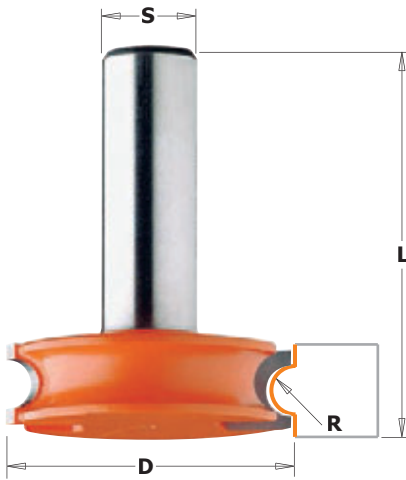

R mm	D mm	L mm	ORDER NO. S=Ø12mm	ORDER NO. S=Ø12,7mm
3,2	38	48,1	955.701.11	855.701.11

Lock miter set



8/955

Now you don't have to fight with those awkward clamps on your 22,5° projects. Use this pair of bits to produce octagonal shaped boxes and popular corner cabinetry like corner cabinets for kitchens, entertainment centres, kitchen islands and corner hutches. This 22,5° Lock Miter set provides a strong tight joint when you want to join wood at 45° angles.

Biscuits and splines are time-consuming to make and difficult to clamp. CMT's matched pair of cutters makes set-up easy. Height adjustment is not critical with this matched pair; simply adjust your fence so the top edge of the work piece intersects the angle of the bit where it meets the fence. After your joints are machined they can be glued and assembled and simply clamped by using strapping tape.

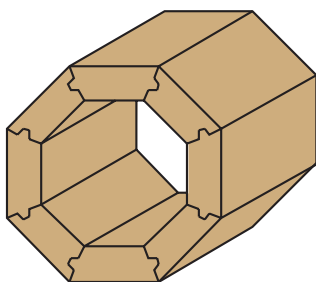
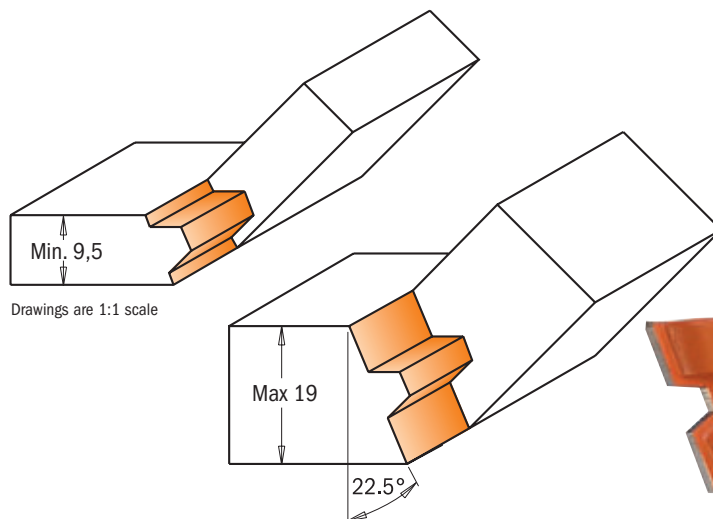
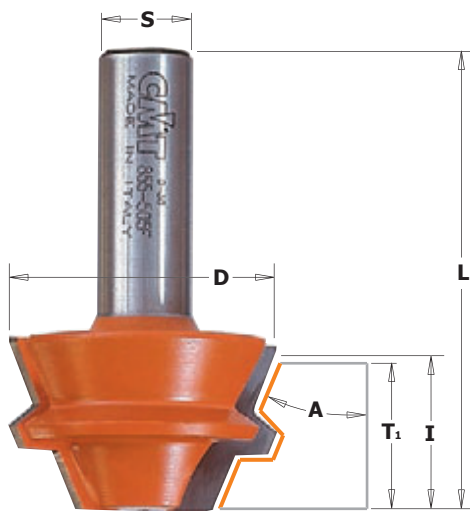

D mm	I mm	A	T1 mm	L mm	ORDER NO. S=Ø8mm	ORDER NO. S=Ø12,7mm
37,3	22,2	22.5°	9,5 ÷ 19	60,3	955.005.11	855.505.11

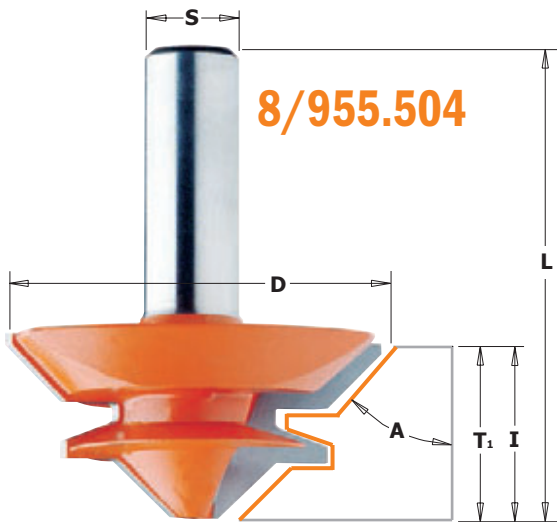

8/955.504

CMT lock miter bits are ideal for milling miter joints in 28,5mm stock. The quick and easy way to accurately create boxes, stretcher bars, frames and any assortment of right angle or parallel joint projects.

To produce perfectly fitting miter joints, lay one piece with the inside face-down on the work table and the wood centred to the bit. Mill as shown in step 1 of the illustration below. Mill the second piece with the inside face placed vertical to the bit and fence, as shown in step 2.

To mill sturdy parallel glue joints follow step 1 shown in the illustration with the inside face of the workpiece laid flat on the table and centred to the bit. To make the second part, lay the workpiece flat on the table and centred to the bit. Mill with the inside face-up.

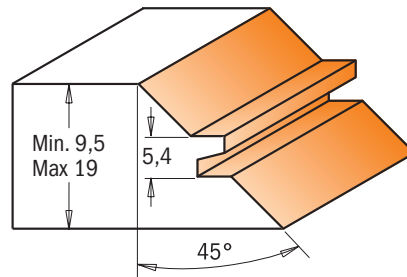
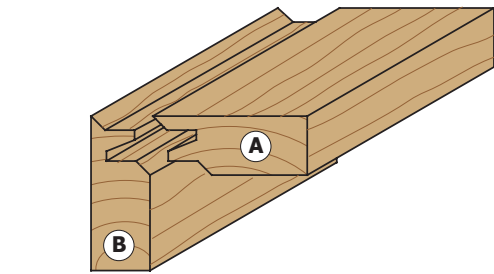

8/955.503

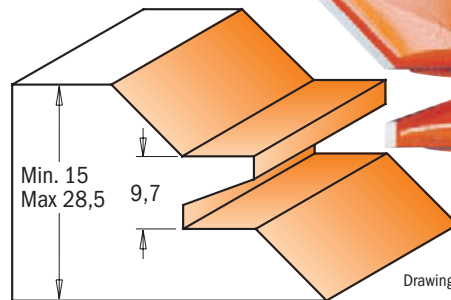
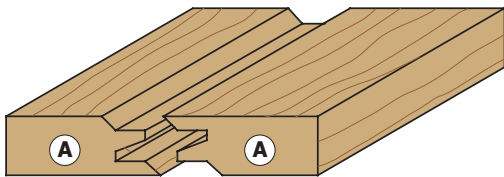

Drawings are 1:1 scale

For miter and parallel glue joints using 19mm board

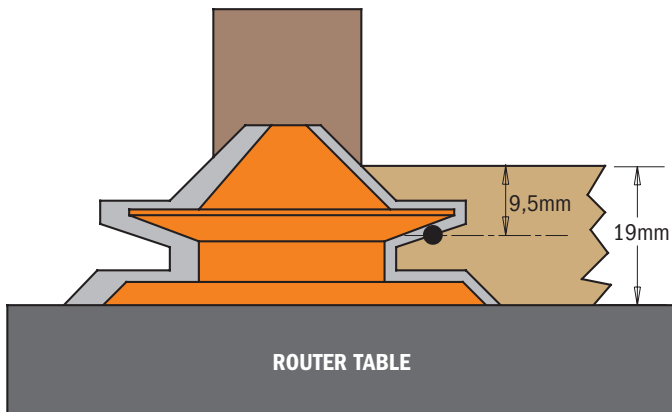

Nr. 1: Rout one piece with the inside face flat on the router table. Be sure the cut is centred to the stock.

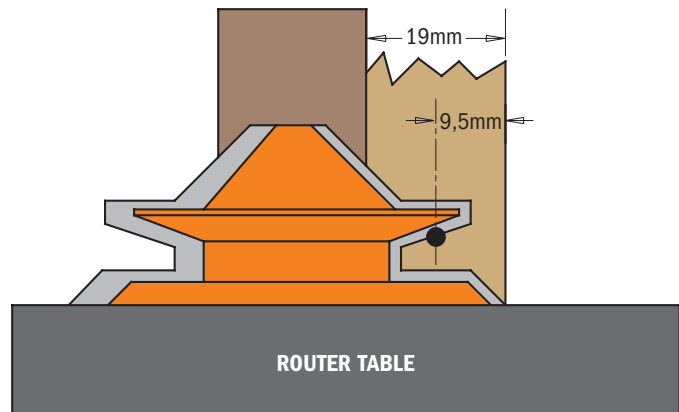

Nr. 2: Rout the second piece with the inside face vertical to the fence.

D mm	I mm	A	T ₁ mm	L mm	ORDER NO. S=Ø12mm	ORDER NO. S=Ø12,7mm
70	31,7	45°	15 ÷ 28,5	69,9	955.503.11	855.503.11
50,8	22,2	45°	9,5 ÷ 19	60,3	955.504.11	855.504.11

Reverse glue joint bits

Saw blades
Jig saw blades
Tools with bore & Knives
Router bits & sets
CNC router cutter & chucks
Industrial dowel drills
Bits for hand power tools
Power tools & accessories
Display cabinets & spare parts

8/955.501



The most unique and important characteristic of this CMT bit is its capacity to produce an almost indestructible glue joint quickly and without error. Ideal for routing wide dimension panels, doors and furniture pieces. By accurately centering the bit to the wood, the upper and lower vertical cutting edges of the bit will cut equal proportions. Simply run one edge of the panel, turn the panel over, and then run the opposite edge - you will produce perfectly harmonized reverse cuts that match up to make flawless joints.

SHOP TIPS: When glueing, apply enough pressure to securely seal the joint. Insufficient pressure results in a weak joint and excessive pressure will distort the wood.

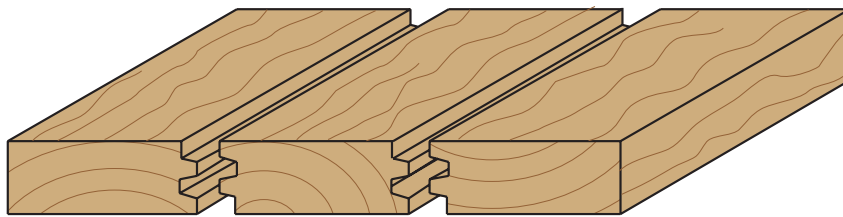
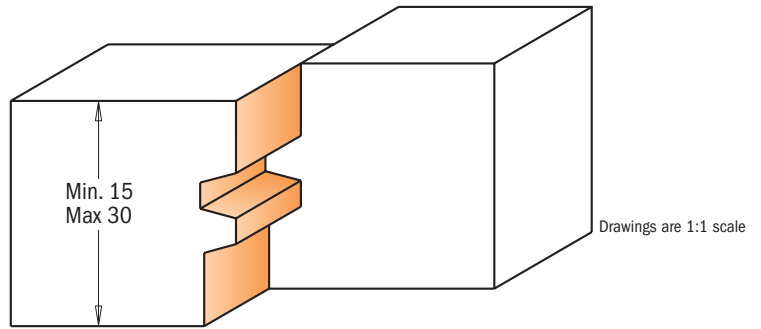
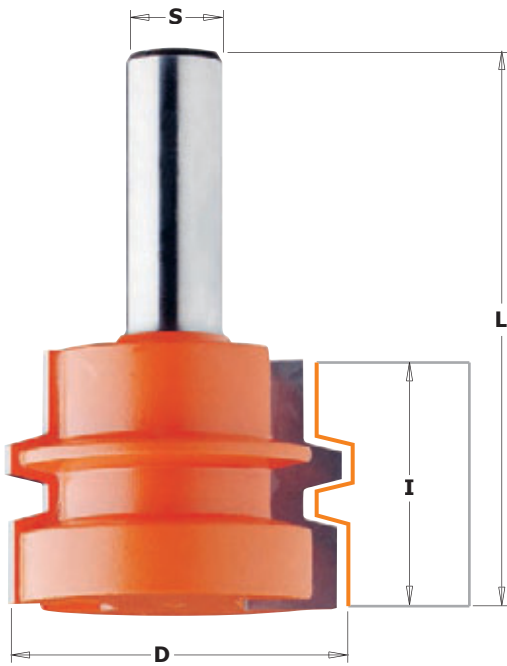

In this example we have used a 19mm board

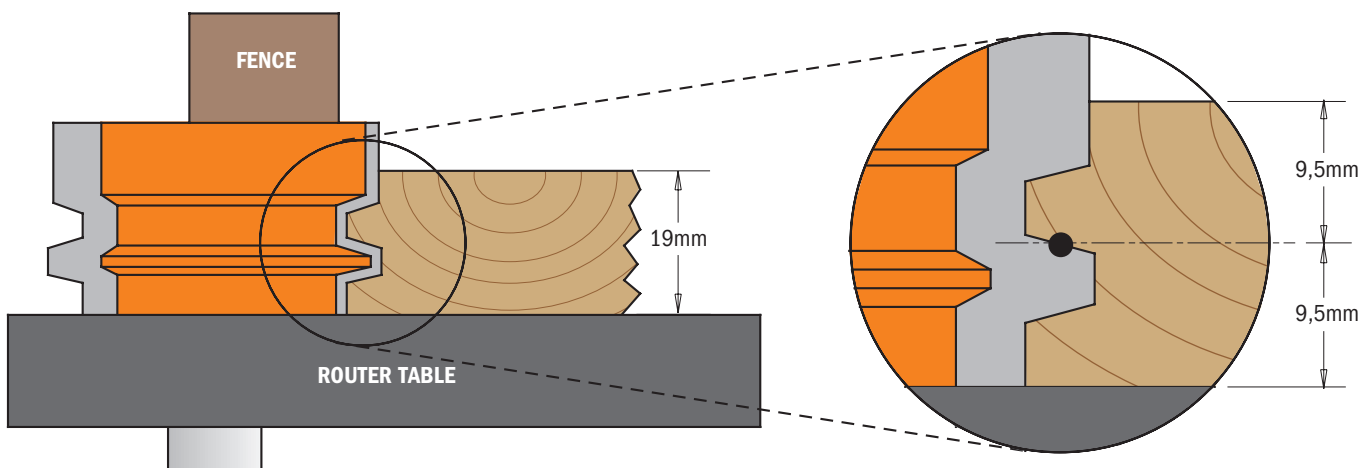

To accurately centre the wood to the bit: Adjust the bit according to the thickness of the wood you are cutting. Line up the cut edge of the wood to the centre point of the bit as illustrated in the enlarged drawing. The upper and lower vertical cutting edges of the bit are in proportion and at an equal distance from the centre point of the bit. Run one cut edge of the wood, turn the piece over and run the other edge for exact reverse cuts that match up perfectly. Assemble the reverse cut pairs together for beautiful, strong joints.

D mm	I mm	T ₁ mm	L mm	ORDER NO. S=Ø12mm	ORDER NO. S=Ø12,7mm
44,4	32	15 - 30	70,1	955.501.11	855.501.11

855.508 - 955.008
7/8/955.002 - 8/955.502



The key to success when constructing quality drawers is in the quality of the drawer lock bit you use. With CMT drawer lock bits you can make strong, perfectly fitting joints quickly and easily. As illustrated below, mill the drawer front with the inside face-down on the work table.

Mill the sides of the drawer with the inside face placed vertical to the bit and fence, and perpendicular to the table.

These bits are to be used on router tables only and are not to be used on hand-held routers.

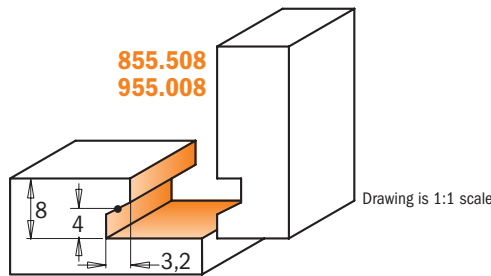
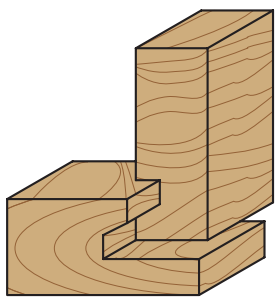
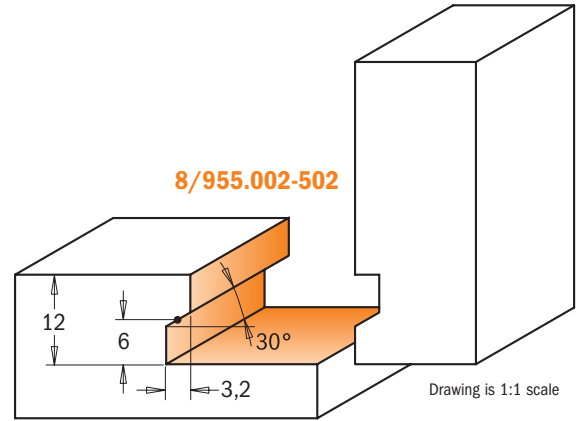
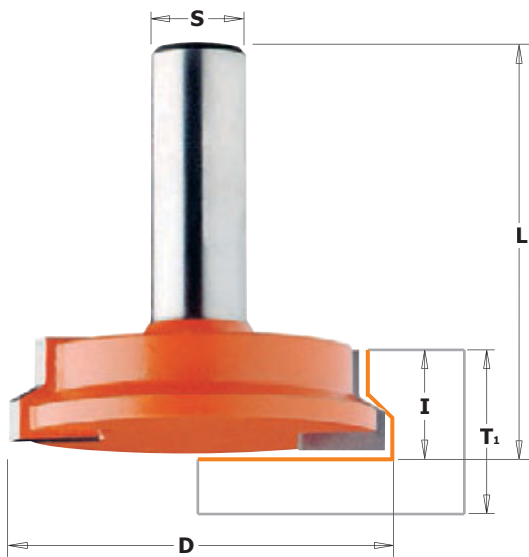

855.508
955.008

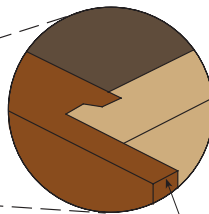
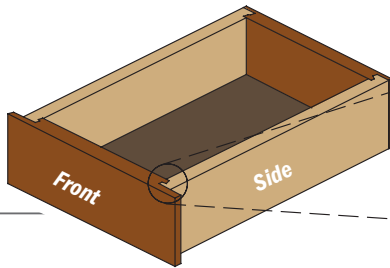
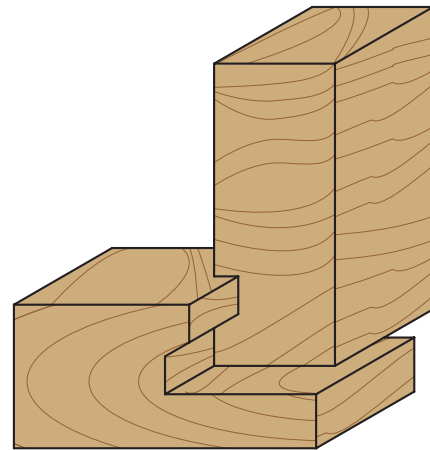

**Overhang
for drawer stop**

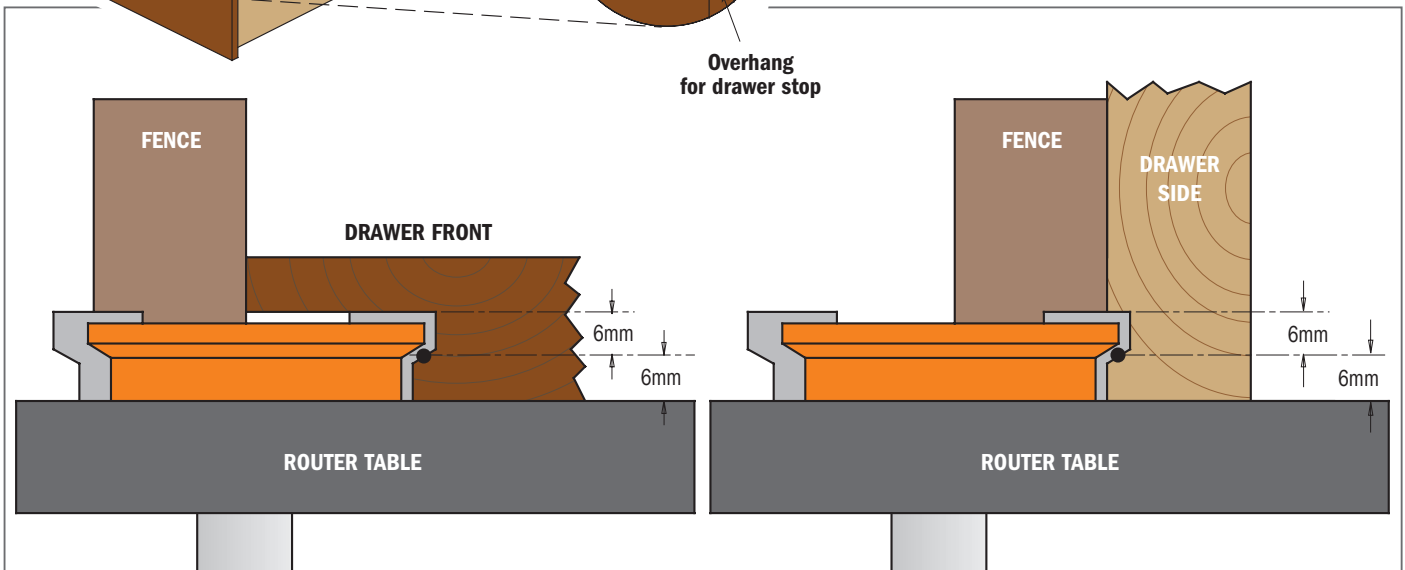

D	T ₁	I	L	ORDER NO.	ORDER NO.	ORDER NO.	ORDER NO.	ORDER NO.
mm	min. mm	max. mm	mm	S=Ø6mm	S=Ø6,35mm	S=Ø8mm	S=Ø12mm	S=Ø12,7mm
25,4	9,5	15,87	12,7			955.008.11		
25,4	9,5	15,87	12,7					855.508.11
31,7	15,87	25,4	12,7	755.002.11	855.002.11	955.002.11		
50,8	15,87	25,4	12,7				955.502.11	855.502.11

Window sash set



8/955.801

CMT designed this set so you can create window sashes that are as beautiful as they are functional. As an additional feature, the CMT window sash set will also mill perfectly joining 35mm rail and stile parts for custom made doors. Like all CMT quality bits, this set includes our anti-kickback design feature and our trademark non-stick orange coating. Made of Fatigue Proof® steel with carbide-faced cutting edges for longer life. Each set contains one 38mm bit and one 35mm bit designed for cutting 35mm stock.

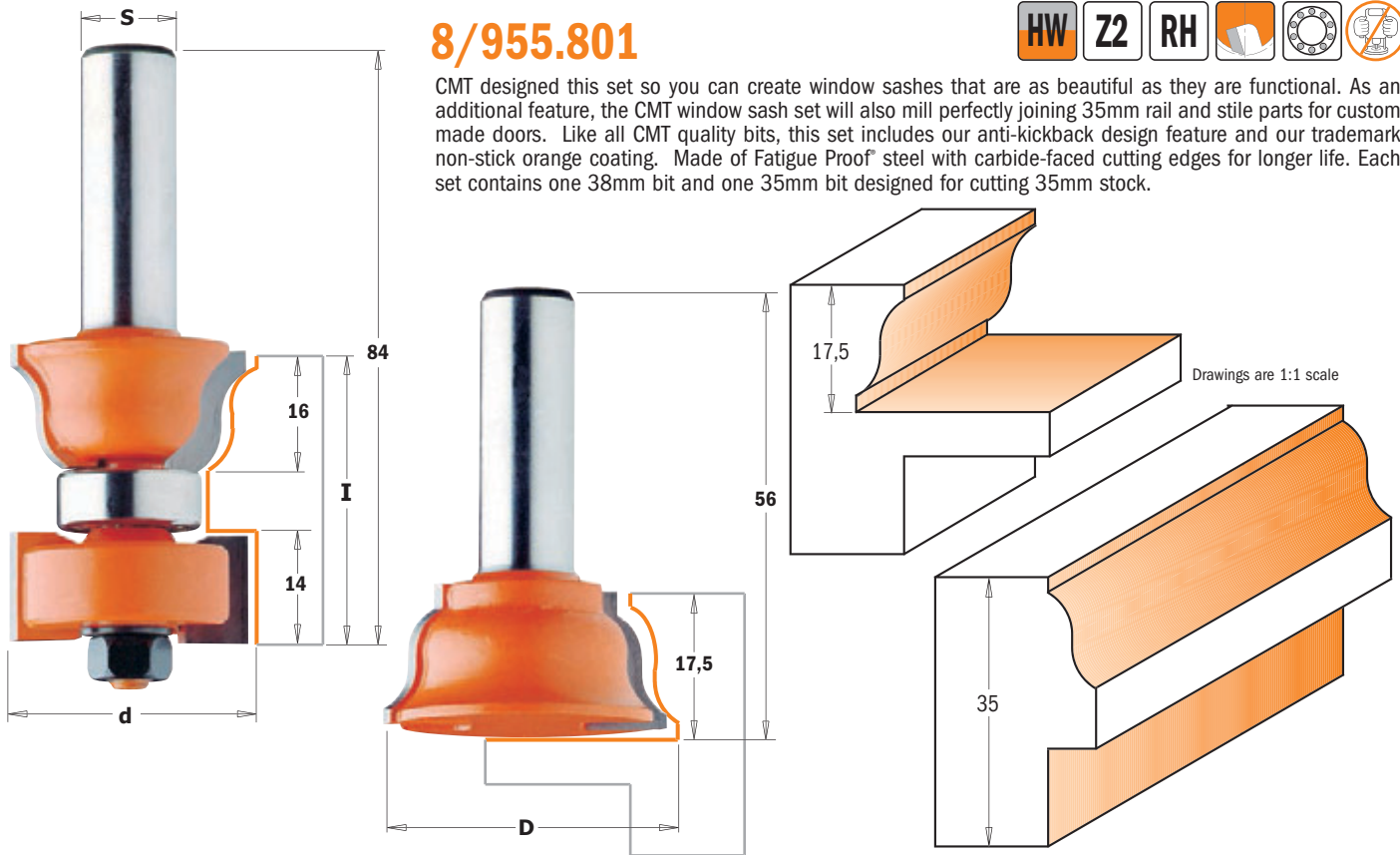

d	I	L	D	I	L	ORDER NO.	ORDER NO.	Spare parts			
mm	mm	mm	mm	mm	mm	S=∅12mm	S=∅12,7mm				
35	35	84	38	17,5	56	955.801.11	855.801.11	791.012.00	822.004.11	541.518.00	990.020.00

Step-by-step window sash construction

Your CMT set makes it easy!

In our step-by-step example for window sash construction, we used the following:

- CMT Window Sash Set (item #855.801.11)
- stiles cut 35mm thick
- rails cut 35mm thick
- scrap stock

The CMT Window Sash Set was designed ideally for the construction of windows in 35mm stock, however variations as narrow as 28mm can be used. Stock thicker than 35mm exceeds the milling range of the cutter. Remember to adjust your measurements and cutting depths according to the wood thickness you use. We suggest making a trial joint in scrap stock according to the following steps before milling all of the cope and stick profiles.

STEP 1 - Measurements and making the tenons

The ideal thickness of the stiles when using the CMT sash set is 35mm. The desired width of the stiles will determine the length you need to make your tenons, while the length of the stile will represent the desired full height of the sash. When cutting the rails to length, make sure to add the length of the two tenons to the overall length of the rail. The length of the tenons should be at least half the width of the stile. Mill 16mm measuring from the front face of the stock using a table saw, radial saw or router as shown in illustration 1. This measurement remains invariable since it is calculated to the height of the CMT sash routers. The width of the tenon is 6mm. Rotate the stock and mill the other side. For our example, the second milling will be 13mm but this measurement will vary if you are using thinner stock.

STEP 2 - Making the cope profile on rails, sash bar and muntins

To make the cope profile, place the rail face front down on the router table with the tenon flush to the bit as shown in illustration 2. Adjust the fence so the bit mills 6,35mm deeper than the tenon. To mill the sash bar and the muntins (cross bars), position front face down on the router table and mill without changing the height of the bit.

STEP 3 - Making the stick profile on rails, stile, sash bar and muntins

To mill the stick profile along the inside edges of all sash parts, place the already milled cope profile front face down on the router table and adjust the sash bit so that the lower edge of the top cutter will exactly touch the upper edge of the tenon as shown in illustration 3. With the rail still face down on the table, turn it so the inside edge of the rail is touching the bit and mill the stick profile. Mill the inside edges of the stiles and mill both edges of the front face of the sash bar and muntins. To cut the slots for the tenons, measure 16mm from the front face of the stiles and rout with a table saw.

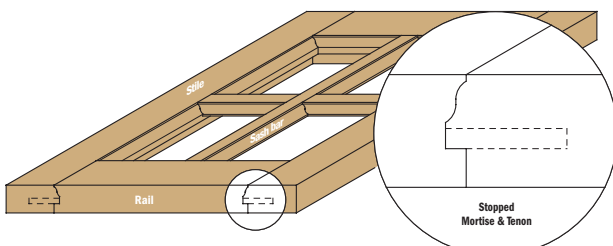
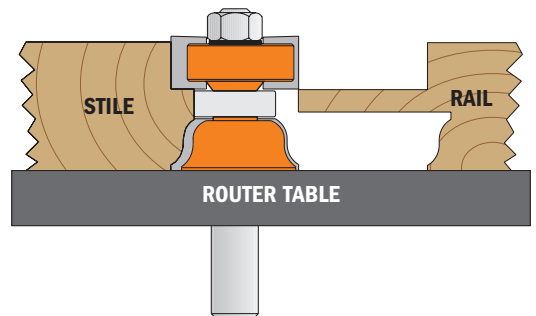
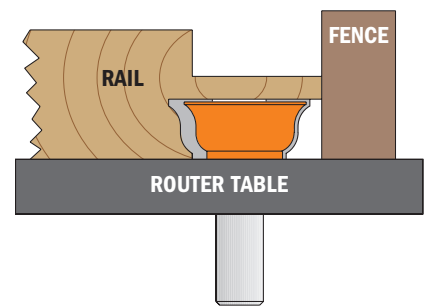
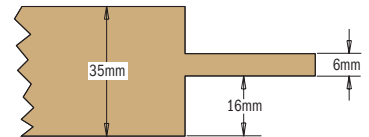

Saw blades
Jig saw blades
Tools with bore & Knives
Router bits & sets
CNC router cutter & chucks
Industrial dowel drills
Bits for hand power tools
Power tools & accessories
Display cabinets & spare parts

Ovolo sash bits

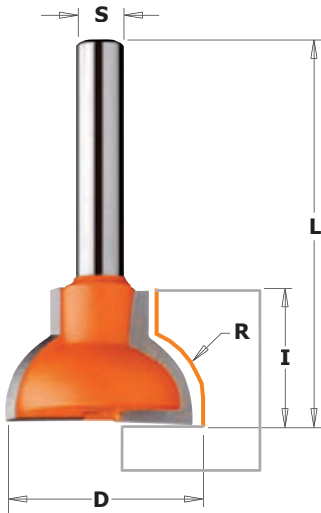

8/955.3

These bits allow you to make true divided light doors for fine furniture and cabinets as well as sash bar windows, and stile and rail constructions.
The glazing bar ovolo bits are bearing-guided to enable curved frames to be moulded.
Cove bits can be used to produce easy-to-pull drawer handles.

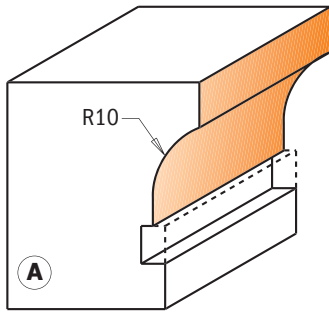

Drawings are 1:1 scale

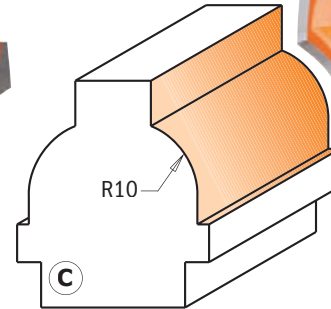
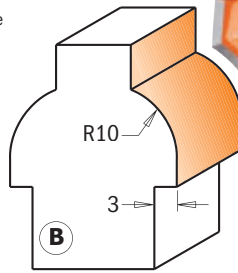

D mm	I mm	R mm	L mm	Profile	ORDER NO. S=Ø6,35mm	ORDER NO. S=Ø8mm
22	19	10	50,8	A	855.307.11M	955.307.11M
22	19	10	50,8	B	855.307.11F	955.307.11F
28	19	10	61,2	C	855.308.11F	955.308.11F

Spare parts



990.423.00 791.003.00 990.058.00 991.057.00

Ovolo sash set



955.302 - 855.802

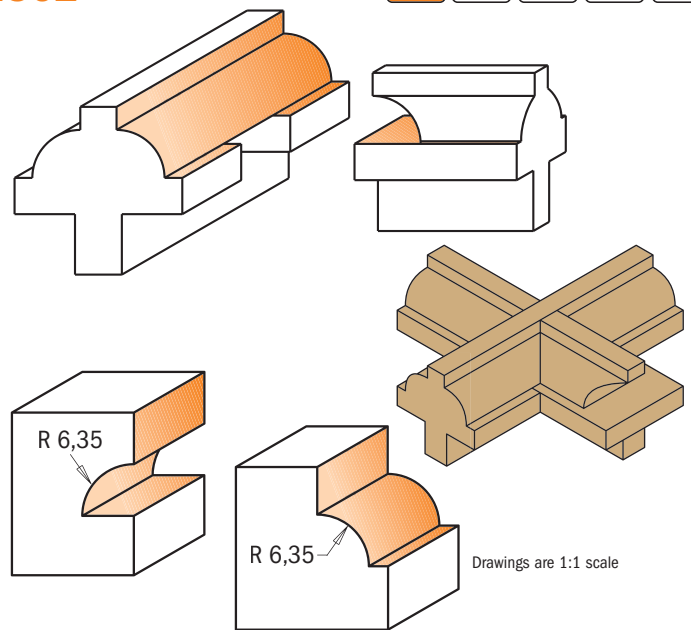
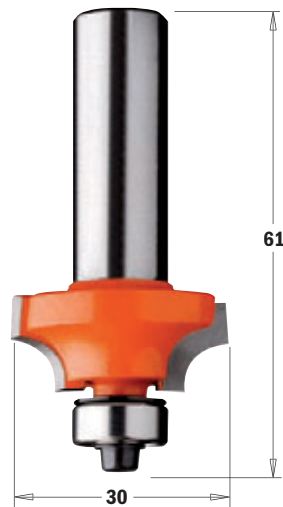

Drawings are 1:1 scale

d mm	D mm	I mm	R mm	ORDER NO. S=Ø8mm	ORDER NO. S=Ø12,7mm
30	31,7	12	6,35	955.302.11	855.802.11

Spare parts



990.423.00 791.003.00 990.058.00 991.057.00 791.011.00 541.002.00

Spare parts 991.056.00 1,5mm hex key

Finger joint bit

Saw blades

Jig saw blades

Tools with bore & Knives

Router bits & sets

CNC router cutter & chucks

Industrial dowel drills

Bits for hand power tools

Power tools & accessories

Display cabinets & spare parts

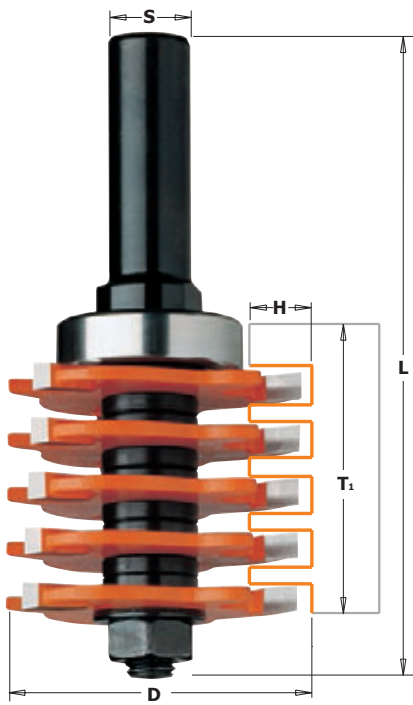

8/900.616

This router allows you to carry out accurate and functional finger joints in a much easier way. Without any adjustment you will be able to work woods with different thicknesses as indicated in the drawing. The bearing allows you to reach a 9,5mm cutting depth. For further cutting depths you need to use a fence.

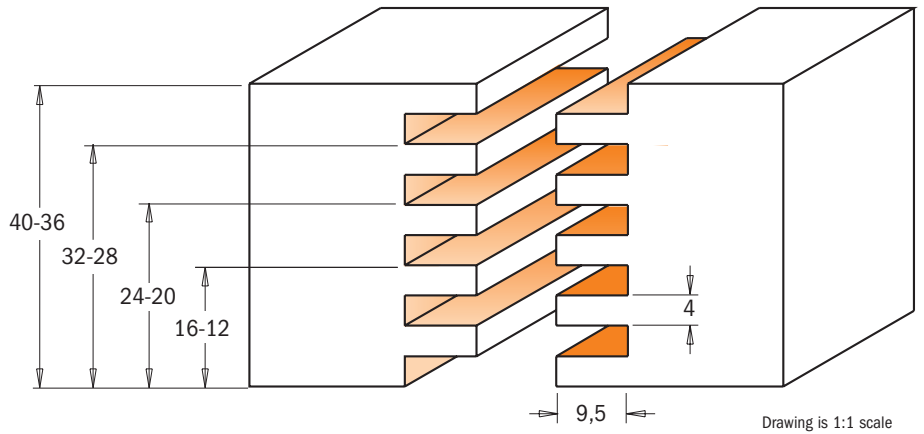

T ₁ mm	D mm	H mm	L mm	ORDER NO. S=Ø12mm	ORDER NO. S=Ø12,7mm	Spare parts				
12 - 40	47,6	9,5	97	900.616.11						
12 - 40	47,6	9,5	97		800.616.11	924.130.00	791.027.00	822.340.11	990.020.00	
						824.130.00	791.027.00	822.340.11	990.020.00	

Spare parts

541.515.00	0,1mm spacer
541.519.00	0,1mm spacer
990.403.00	1,6mm washer
990.459.00	Kit with spacers

Optional

791.020.00	Ø38,1mm bearing (for depth 4,75mm)
791.029.00	Ø34,9mm bearing (for depth 6,35mm)
791.015.00	Ø31,7mm bearing (for depth 8mm)
791.011.00	Ø19mm bearing (for depth 14,3mm)



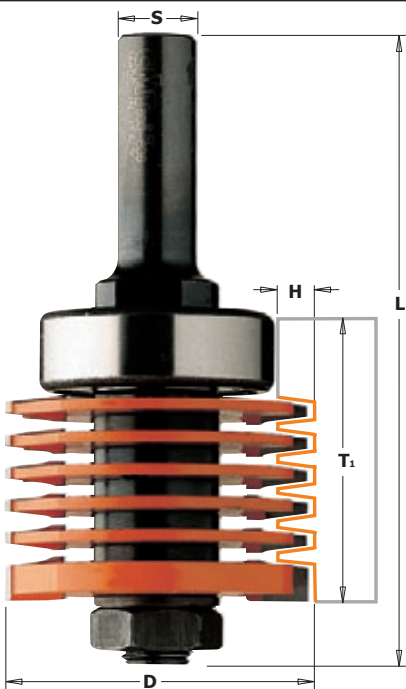

Professional finger joint bit

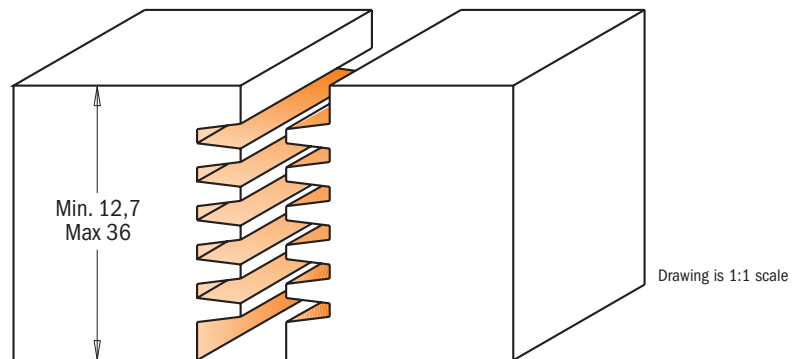

8/900.606

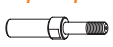
This versatile CMT finger joint bit lets you make one of the most incredibly strong side-to-side or end-to-end joints in all wood and wood composites. The tightness of the accurately cut joint and the maximum glue surface create a joint that is actually stronger than an unworked piece of wood. CMT's professional finger joint features two flute design, carbide teeth and six removable cutters so you can make joints in a wide range of stock thicknesses, from 12,7mm to 36mm. Ideal for molding manufacturers and furniture makers.



T ₁ mm	D mm	H mm	L mm	ORDER NO. S=Ø12mm	ORDER NO. S=Ø12,7mm	Spare parts					
12,7 - 36	47,6	5,5	97	900.606.11							
12,7 - 36	47,6	5,5	97		800.606.11	924.129.00	791.028.00	822.005.11	822.006.11	990.022.00	
						824.129.00	791.028.00	822.005.11	822.006.11	990.022.00	

Spare parts

541.511.00	3mm spacer	541.513.00	0,1mm spacer
541.512.00	2mm spacer	990.458.00	Kit with spacer

V-Tongue and groove set

8/955.506



If the standard selection of molding and mill work you find in today's lumber shops isn't satisfactory to your woodworking tastes, then look to CMT's molding system instead. With these bits, you can make dozens of elaborate profiles by combining two or more passes. Avoid the average and create your own moldings. Some initial suggestions are illustrated below.

SAFETY TIPS: Use these bits with a fence. The profiles shown below are milled from heavy stock then refined to the desired shape.

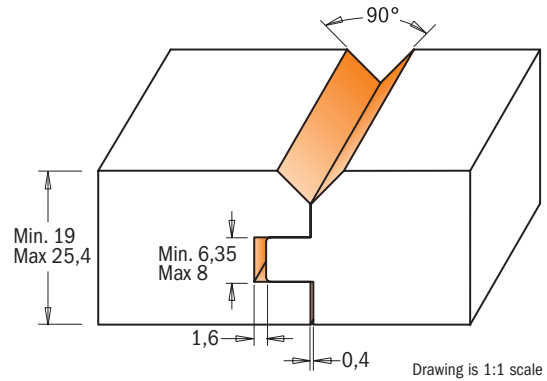
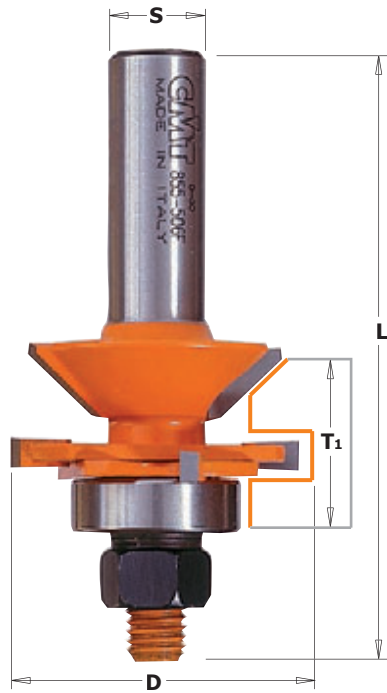

D mm	T ₁ mm	L mm	ORDER NO. S=Ø12mm	ORDER NO. S=Ø12,7mm	Spare parts				
44,4	19÷25,4	75,5	955.506.11	855.506.11	8mm	4mm	19mm	22mm	990.020.00

Spare parts
541.515.00 0,1mm spacer
541.516.00 0,3mm spacer

541.517.00 0,5mm spacer
990.407.00 Shield

Edge banding bits set

8/955.510



This is a great set to create economical but attractive and durable edge to your cabinet doors. Use 1/2" or 1" thick panels in plywood or MDF and create your own edge banding from the wood of your choice. Easy to use: just center each cutter on the stock and make the cut; glue together the two pieces and flush trim it after assembly if necessary. The set features a 60° tongue & groove for a large surface area for glue.

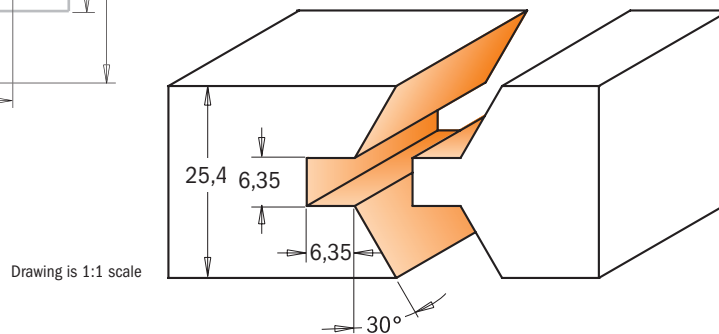
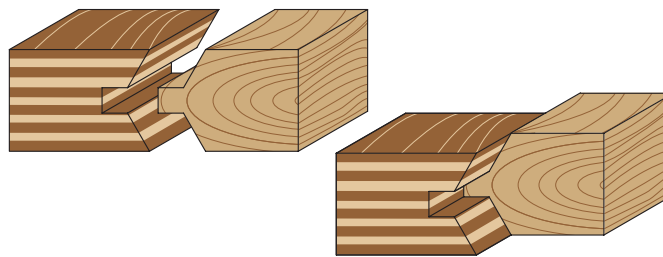
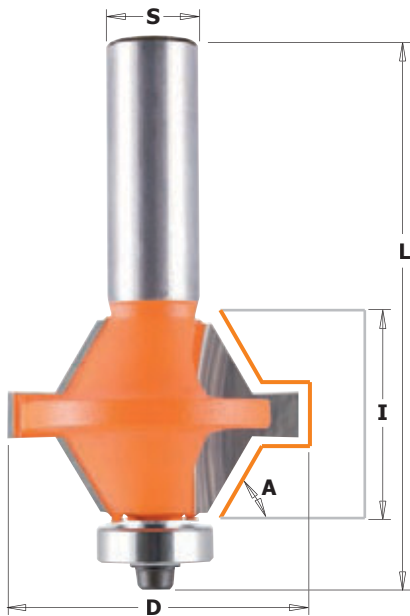

D mm	I mm	A	L mm	ORDER NO. S=Ø12mm	ORDER NO. S=Ø12,7mm	Spare parts			
40	25,4	30°	74,5	955.510.11	855.510.11	990.423.00	791.018.00	990.058.00	991.057.00

Dovetail bits

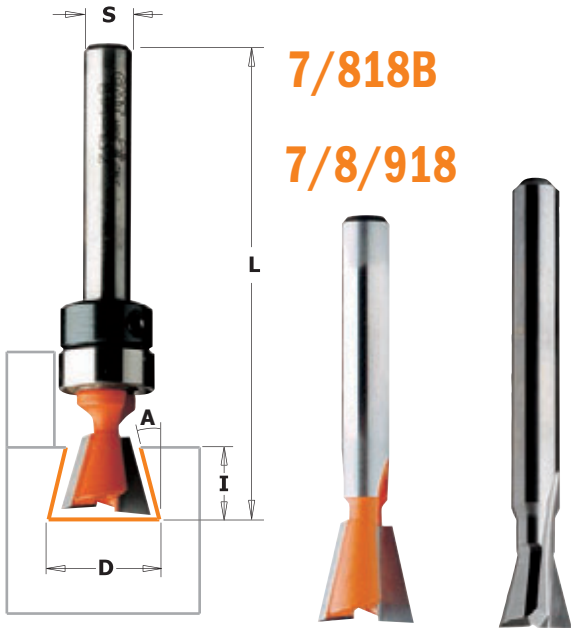

The beautifully crafted dovetail joint is a classic that appeals to both professionals and novices alike. Admired for its attractiveness in box and exposed joint projects, the dovetail is remarkably strong and functional. CMT dovetail bits are available in 25 different sizes so you can stretch your creativity to the limit. See the illustrations on the next page for dovetail joinery possibilities.

CMT dovetail bits are designed to fit all popular jigs including Leigh, Keller, JointTECH and Omnijig systems. You are sure to find the bit you are looking for in our vast selection of cutting sizes and angles. Check the overall length of the bit before placing an order to be sure you get the size you need - CMT makes bits specifically to fit on jigs and routers that require a longer shank length.

SHOP TIPS: Two passes are recommended when routing dovetails with a template. Check that the dovetails have been cut through completely and smoothly before removing the workpiece. For even easier routing and less stress on your dovetail bit, run the first pass with a straight bit. Use a dovetail on your router table equipped with a fence to achieve difficult chamfer angles.

SAFETY TIPS: If a dovetail bit jams while working, adjust the position of the bit in the collet and make sure the cutting depth is correct. Do not lift the router out of the template.

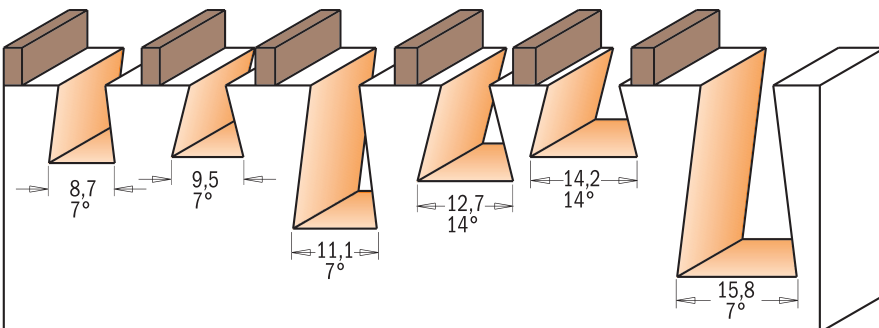
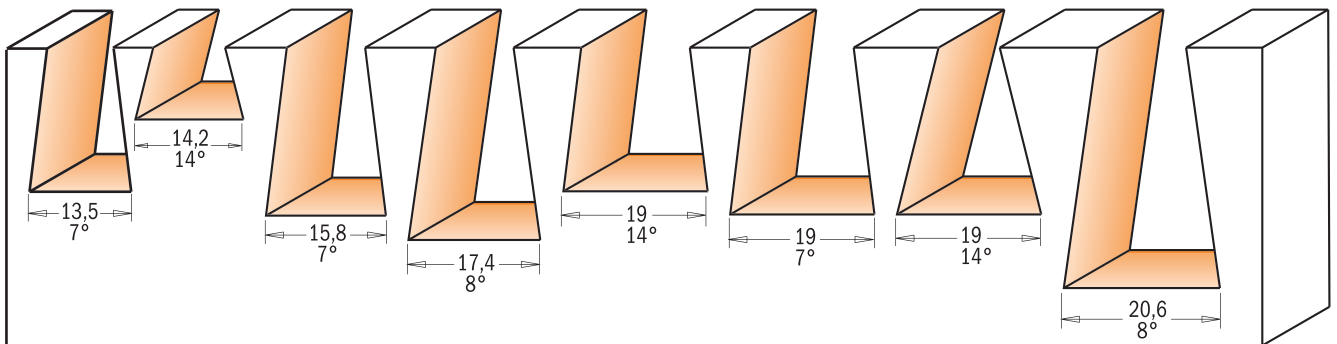
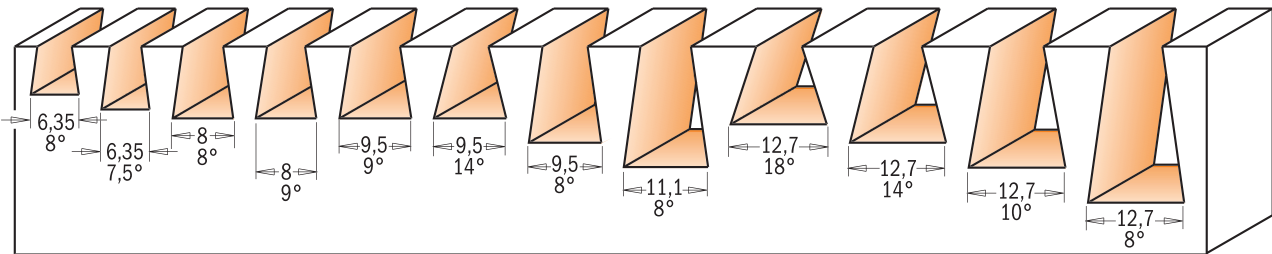

Manufacturer/Model		ORDER NO.
CMT-Enlock10	718.098.11B	818.098.11B
CMT-Enlock15	718.127.11B	818.128.11B
CMT300	718.127.11	818.128.11
	918.127.11	818.628.11

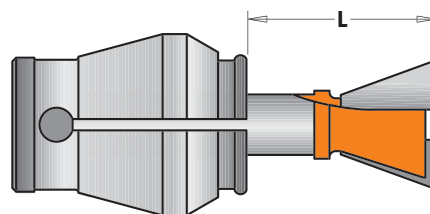
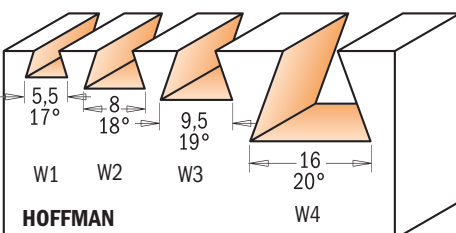

Manufacturer/Model		ORDER NO.
HOFFMAN		
W1	L=16mm	718.053.11 818.053.11
W2	L=17,5mm	718.079.11 818.079.11
W3	L=19mm	718.093.11 818.093.11
W4	L=25mm	918.167.11

Drawings are 1:1 scale

Saw blades
 Jig saw blades
 Tools with bore & Knives
 Router bits & sets
 CNC router cutter & chucks
 Industrial dowel drills
 Bits for hand power tools
 Power tools & accessories
 Display cabinets & spare parts

7/8/918 - 7/818B



Here are a few of the beautiful dovetail joints you can produce using CMT bits

Through dovetail

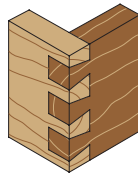

Half-blind dovetail

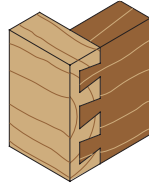

Variably-spaced dovetail

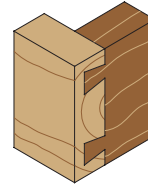

Sliding dovetail

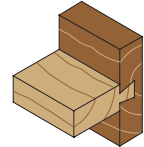

A few seconds and your joints are ready!

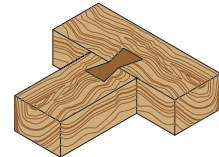
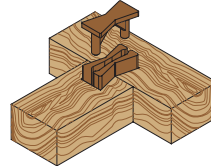
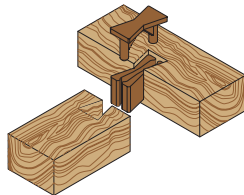

D mm	I mm	L mm	A	ORDER NO. S=Ø6mm	ORDER NO. S=Ø6,35mm	ORDER NO. S=Ø8mm	ORDER NO. S=Ø12mm	ORDER NO. S=Ø12,7mm	Spare parts		
•6	8,3	60	7,5°	718.060.11							
•6,35	6,35	50,8	8°		818.065.11						
•6,35	8,3	63,5	7,5°		818.064.11			818.564.11			
•8	9,5	54	8°		818.081.11						
•8	9,5	52,5	9°		818.080.11						
•8	9,5	63,5	9°					818.580.11			
9,5	9,5	52,5	9°	718.095.11	818.096.11	918.095.11					
9,5	9,5	63,5	9°					818.596.11			
•9,5	9,5	60,3	14°		818.098.11						
•9,5	12,7	60,3	8°		818.097.11						
11,1	15,9	60,3	8°		818.111.11						
12,7	10,3	60,3	18°		818.132.11						
12,7	12,7	52,4	14°	718.127.11	818.128.11	918.127.11					
12,7	12,7	63,5	14°					818.628.11			
12,7	12,7	62	14°		818.130.11						
12,7	16	60,3	10°		818.133.11						
12,7	20,6	69,8	8°		818.129.11	918.129.11					
13,5	19,05	61,5	7°					818.635.11			
14,2	9,5	50,8	14°		818.142.11						
15,8	22	60,3	7°	718.158.11	818.158.11	918.158.11					
15,8	22	66,7	7°				918.658.11	818.658.11			
17,4	25,4	77,6	8°					818.674.11			
19	19	77,6	14°					818.691.11			
19	22	60,3	7°	718.190.11	818.190.11	918.190.11					
19	22	66,7	7°				918.690.11	818.690.11			
19	22	60,3	14°		818.191.11						
20,6	31,7	84,1	8°					818.706.11			
with top bearing											
8,73	10,3	58	7°		818.087.11B				791.009.00	541.001.00	
•9,5	9,5	60,3	14°	718.098.11B	818.098.11B				791.010.00	541.001.00	
11,1	19	66,7	7°		818.113.11B				791.009.00	541.001.00	
12,7	12,7	52,4	14°	718.127.11B	818.128.11B				791.010.00	541.001.00	
14,2	9,5	50,8	14°		818.142.11B				791.010.00	541.001.00	
with top bearing (shank Ø9,5mm)											
15,8	25,4	68,3	7°			818.159.11B			791.021.00	541.006.00	
for Hoffman											
•5,5	4	43	17°	718.053.11	818.053.11						
•8	6	43	18°	718.079.11	818.079.11						
•9,5	7,3	43	19°	718.093.11	818.093.11						
16,7	12,5	49	20°			918.167.11					

Spare parts 990.005.00 M3x3mm TSEI screw
991.056.00 1,5mm hex key

• HWM

9° Dovetail cutters

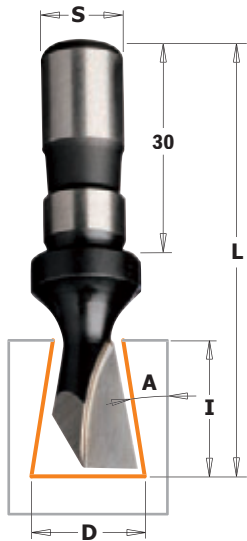

522

HW Z1 RH

D mm	I mm	L mm	A	S mm	ORDER NO. Right-hand rotation
14	18	60	9°	12	522.140.11

TECHNICAL DETAILS:
 - Super strength steel
 - 1 HW precision ground cutting edge (Z1)

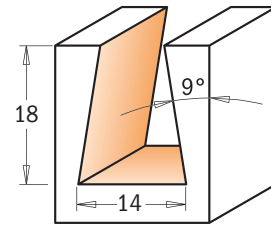

Drawing is 1:1 scale

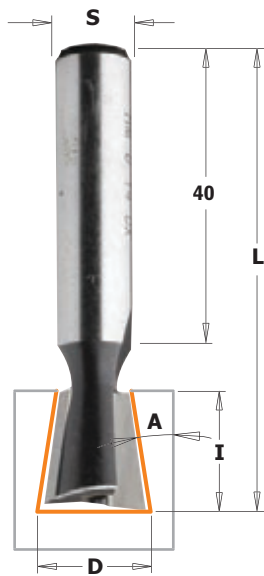

523

HW Z2 RH

D mm	I mm	L mm	A	S mm	ORDER NO. Right-hand rotation
14	16	60	9°	10	523.140.11

TECHNICAL DETAILS:
 - Super strength steel
 - 2 HW precision ground cutting edges (Z2)

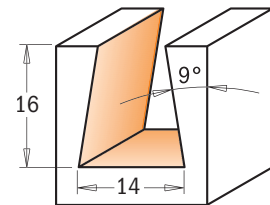

Drawing is 1:1 scale

15° dovetail cutter with insert knives for roof-frames

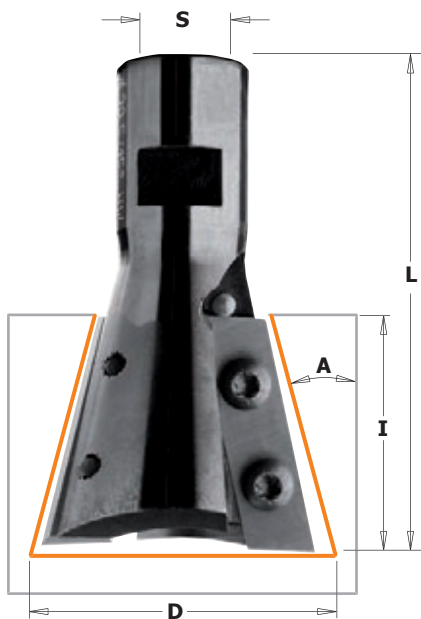

664

INSERT CARBIDE Z2 RH

D mm	I mm	L mm	A	S	ORDER NO. Right-hand rotation
39,5	31,5	65,5	15°	M12x1	664.395.11

Spare parts

790.315.00	990.078.00	991.061.00

TECHNICAL DETAILS:
 - Super strength steel
 - 2 HWM precision insert knives (Z2)

APPLICATION:
 This cutter allows you to assembly roof-frames by dovetailing.

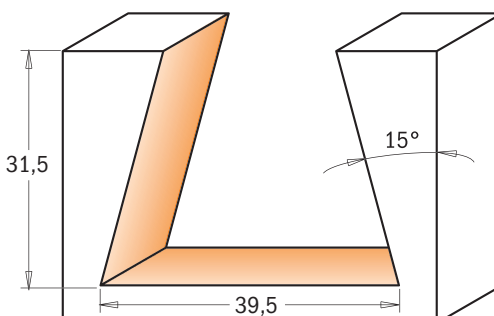

Drawing is 1:1 scale

Saw blades
 Jig saw blades
 Tools with bore & Knives
 Router bits & sets
 CNC router cutter & chucks
 Industrial dowel drills
 Bits for hand power tools
 Power tools & accessories
 Display cabinets & spare parts

60° Lettering bit

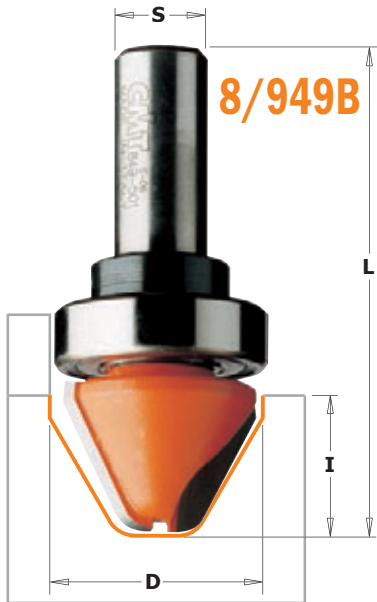

7/8/949

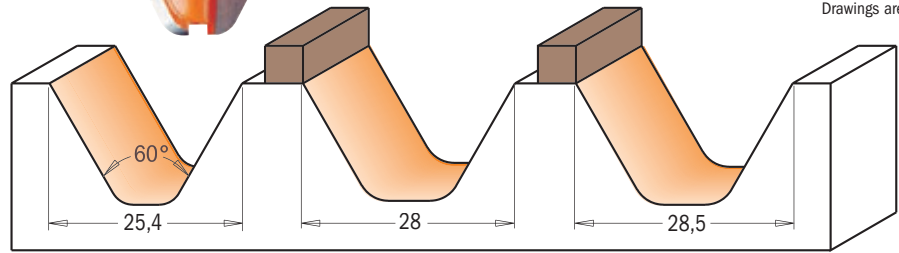

The ideal bit for routing signs. CMT has designed a bit with a 60° curved profile, a 3,2mm (1/8") radius and a flattened bottom to make relief letter-making easy and accurate. This exclusive design allows you to efficiently level off the area around the base of the letter and bevel the letter edges to eliminate aggravating splintering. Try our 60° lettering bit with top bearing guide to get even more precise decorative effects.

D mm	I mm	A	L mm	ORDER NO. S=Ø6mm	ORDER NO. S=Ø6,35mm	ORDER NO. S=Ø12mm	ORDER NO. S=Ø12,7mm	Spare parts		
25,4	19	60°	50,8	749.001.11	849.001.11					
28	19	60°	63,5			949.502.11				
28,5	19	60°	63,5				849.501.11			
with top bearing										
28	19	60°	63,5			949.502.11B		791.026.00	541.005.00	991.056.00
28,5	19	60°	63,5				849.501.11B	791.027.00	541.002.00	991.056.00

Spare parts 990.005.00 M3x3mm STEI screw

Bowl and tray bits

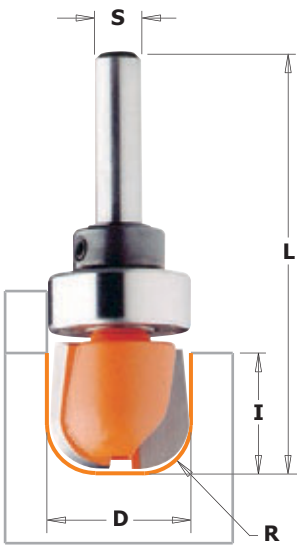

7/851B



7/8/951

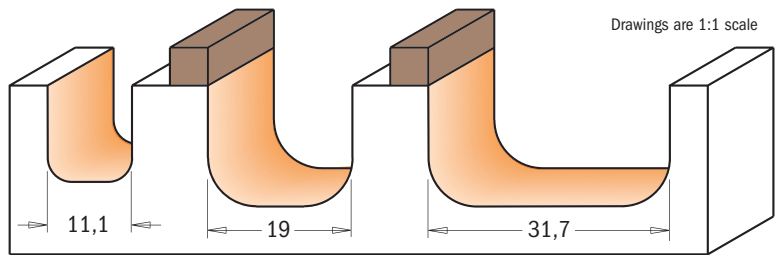

This CMT bit is ideal for making bowls, trays, boxes, cutting boards or any other specialty or craft item. The round corner of the bit shapes the inner radius while the sides and bottom create the smooth flat surfaces. Makes pattern work quick and easy. For best results on jobs where accuracy is a priority we recommend using our top bearing bowl and tray bits shown at bottom of page. Bowl and Tray bits with top bearings are great for pattern work. Use them to create raised sign lettering, trays and many other items.

D mm	I mm	R mm	L mm	ORDER NO. S=Ø6mm	ORDER NO. S=Ø6,35mm	ORDER NO. S=Ø8mm	ORDER NO. S=Ø12mm	ORDER NO. S=Ø12,7mm	Spare parts		
11,1	12,7	3,2	45,5		851.001.11						
19	16	6,4	54	751.002.11	851.002.11	951.002.11					
19	16	6,4	60,4				951.501.11	851.501.11			
31,7	16	6,4	60,4				951.502.11	851.502.11			
with top bearing											
19	16	6,4	54	751.002.11B					791.007.00	541.003.00	991.056.00
19	16	6,4	54		851.002.11B				791.004.00	541.001.00	991.056.00
19	16	6,4	60,4					851.501.11B	791.011.00	541.002.00	991.056.00
31,7	16	6,4	60,4				951.502.11B	851.502.11B	791.015.00	541.002.00	991.056.00

Spare parts 990.005.00 M3x3mm STEI screw

V-Grooving bits (90°)



7/8/915

These double cutting edge CMT bits offer an almost endless range of woodworking possibilities. Make clean, perfect cuts in panels, drawer fronts or even plasterboard panels; chamfer edges or engrave beautiful lettering.

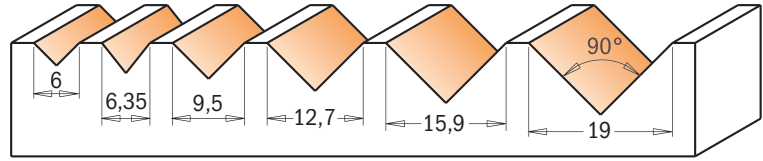

Drawings are 1:1 scale

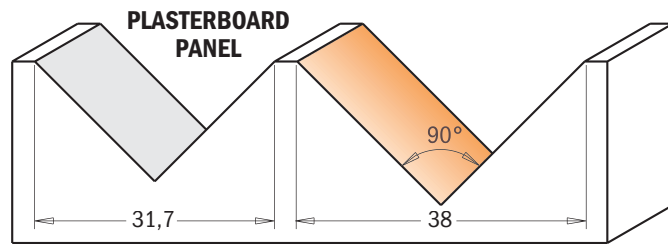

• HWM

D mm	I mm	A	L mm	ORDER NO. S=Ø6mm	ORDER NO. S=Ø6,35mm	ORDER NO. S=Ø8mm	ORDER NO. S=Ø12mm	ORDER NO. S=Ø12,7mm
•6	8	90°	38,1	715.060.11		915.060.11		
•6,35	8	90°	38,1		815.064.11			
9,5	12,7	90°	44,5	715.095.11	815.095.11	915.095.11		
12,7	12,7	90°	44,5	715.127.11	815.127.11	915.127.11		
16	12,7	90°	52,8			915.160.11		
16	12,7	90°	63,5				915.660.11	815.660.11
19	16	90°	55,5	715.190.11				
19	16	90°	63,5				915.690.11	815.690.11
31,7	16	90°	63,5			915.317.11	915.817.11	815.817.11
38	19	90°	63,5			915.380.11		
38	19	90°	70					815.880.11

7/8/915B



In addition, CMT has versatile top bearing bits that allow for several template options of your choice (see series 715B-815B-915B). Like all CMT bits, they are made of super strength Fatigue Proof® steel with carbide-tipped cutting edges and are coated with our trademark orange PTFE non-stick coating. These bits are ideal for routing signs, or almost any project that is suitable for accurate template routing.

TIPS: V-grooving bits can perfectly chamfer 45°. Two tools in one!

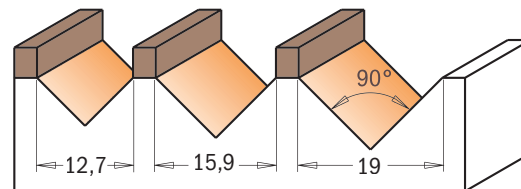

Drawings are 1:1 scale

D mm	I mm	L mm	A	ORDER NO. S=Ø6mm	ORDER NO. S=Ø6,35mm	ORDER NO. S=Ø8mm	ORDER NO. S=Ø12,7mm	Spare parts		
12,7	12,7	44,5	90°		815.127.11B					
16	12,7	52,8	90°			915.160.11B		791.010.00	541.001.00	991.056.00
19	16	55,5	90°	715.190.11B				791.025.00	541.004.00	991.056.00
19	16	63,5	90°				815.690.11B	791.007.00	541.003.00	991.056.00
								791.011.00	541.002.00	991.056.00

Spare parts 990.005.00 M3x3mm STEI screw

Saw blades
Jig saw blades
Tools with bore & Knives
Router bits & sets
CNC router cutter & chucks
Industrial dowel drills
Bits for hand power tools
Power tools & accessories
Display cabinets & spare parts



915

ALUCOBOND® plus composite panels can be shaped using a very simple processing method. The technique, called the routing and folding method, enables a fabricator to produce shapes of various kinds and sizes.

A V-shaped groove is routed on the reverse side of the ALUCOBOND® plus composite panel using a “V” groove router bit. A thin layer of the core material should be left at the base of the groove, i.e. on the inside of the outer cover sheet. The untouched outer cover sheet can now be bent manually, giving an exact and clean folding line which follows the routed groove. The outer radius of the folded edge depends on the shape of the groove and its depth.

We recommend that the routing be done using a CNC machining centre, a portable sheet milling machine or a hand router. The routing and folding method can be used for ALUCOBOND® plus composite panels with all available standard surface finishes. The advantages of this unique technique are:

- Low investment cost
- Simple fabrication technique
- Folding can be done on site, saving transportation cost
- Low-cost fabrication of shaped components, wall cladding, roof edgings, column cladding, flashings, etc.
- Flexibility in creating shapes
- Very economical
- Shapes are not limited by machine capacity.

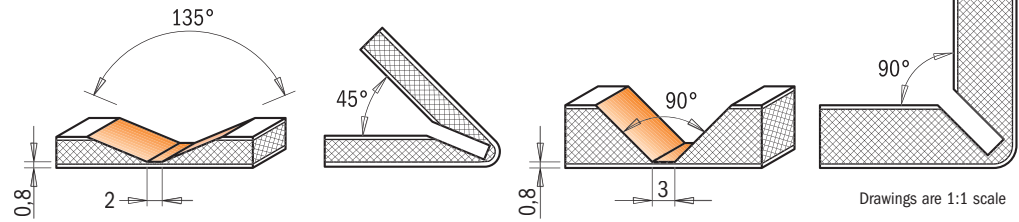

D mm	I mm	A	L mm	ORDER NO. S=Ø8mm
18	7,45	90°	60	915.001.11
18	3,3	135°	60	915.002.11

Laser point bit (60°) Z=3



7/858.002

7/8/958



This new bit lets you make delicate grooves and incisions with laser precision. Make one of a kind effects with single run 30° bevel edges. Three super sharp cutting edges and this perfectly balanced bit allow you to work with superior accuracy with no risk of burning. Raise the bit and produce a delicate fine point incision, or work the whole 12,7mm diameter to render bold highlighted lettering. Super strong steel shank and micrograin carbide cutting edges guarantee long lasting performance.

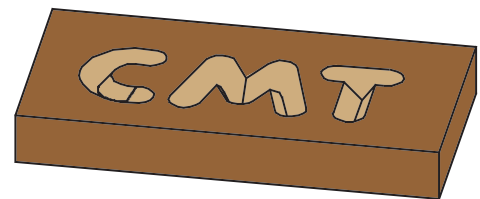
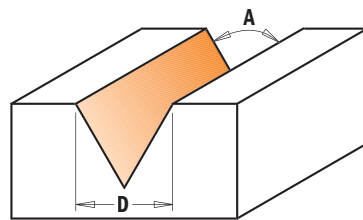

D mm	I mm	A	Z	L mm	ORDER NO. S=Ø6mm	ORDER NO. S=Ø6,35mm	ORDER NO. S=Ø8mm	ORDER NO. S=Ø12,7mm
• 6	9	35°	1	50	758.002.11			
• 6,35	9,5	35°	1	50,8		858.002.11		
12,7	11	60°	3	57,2	758.001.11	858.001.11	958.001.11	
12,7	11	60°	3	60,3				858.501.11

• HWM

V-grooving & signmaking router bits with indexable knives (90°)

new

CMT ORANGE TOOLS™

INSERT CARBIDE Z1 RH

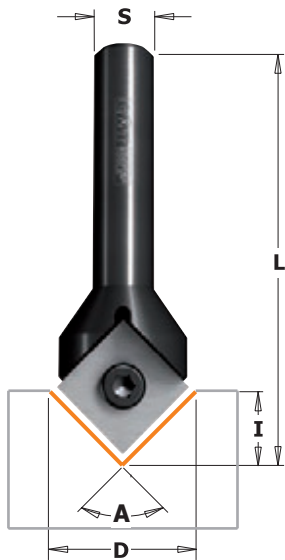



665

These bits have been designed for signmaking and lettering. When insert shows signs of wear, you can simply rotate it to exploit the other cutting edges. Locking screw secures insert tightly for safety and high cutting accuracy.

TECHNICAL DETAILS:

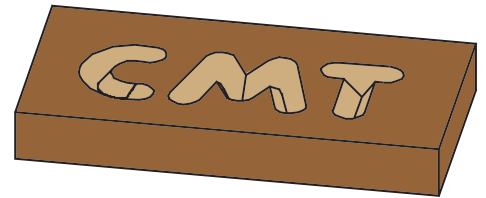
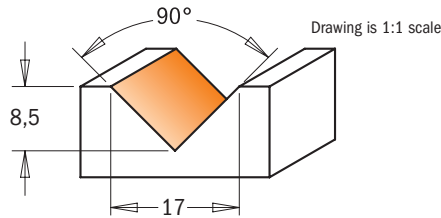
- Super strength steel.
- 1 HW precision insert knife [Z1].



A	D mm	I mm	L mm	ORDER NO. S=Ø6,35mm	ORDER NO. S=Ø8mm	Spare parts		
90°	17	8,5	53	665.171.11	665.170.11	 790.120.00	 990.076.00	 991.061.00

Stepped rebate router bit

new

HW Z2 RH

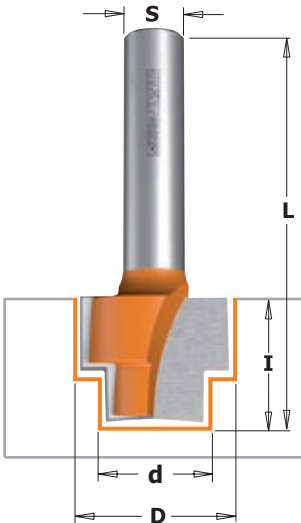

965

Router bit featuring 2 carbide-tipped cutting edges for producing double rebates on wood and wood composites. Designed for accepting library/bookcase shelving strips or for accommodating hardware into your window slots.

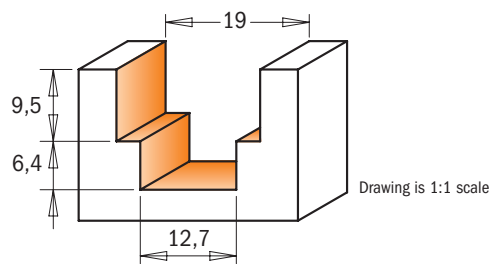

d mm	D mm	I mm	L mm	ORDER NO. S=Ø8mm
12,7	19	15,9	50,8	965.121.11

Saw blades

Jig saw blades

Tools with bore & Knives

Router bits & sets

CNC router cutter & chucks

Industrial dowel drills

Bits for hand power tools

Power tools & accessories

Display cabinets & spare parts

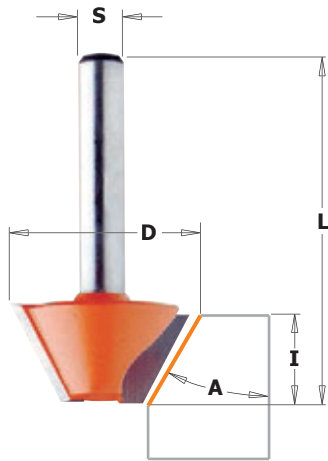

703/4/5 - 903/4/5



From a gently beveled edge to decorative chamfers in a variety of materials, CMT offers smooth results.

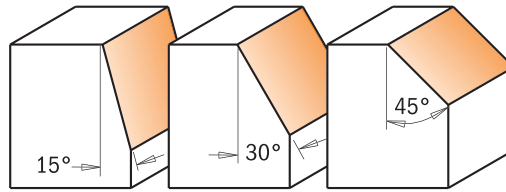

Drawings are 1:1 scale

A	D mm	I mm	L mm	ORDER NO. S=Ø6mm	ORDER NO. S=Ø8mm
15°	24	14	46	703.240.11	903.240.11
30°	26	12,7	44,5	704.240.11	904.240.11
45°	25	8	41	705.240.11	905.240.11

Chamfer bits with insert knives

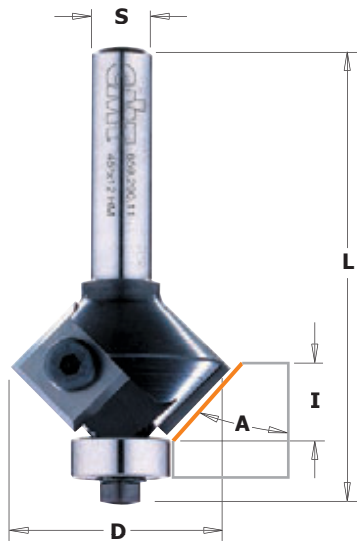

659



Bevel and Chamfer trim bits with two replaceable knives fixed by special Torx screws. The knives are 4 sided sharpened and gives three extra new edges. Guided bevel and chamfer trim bits type 659 are equipped with the ball bearing guides. Type 658 is unguided. For specialist applications requiring economy of replaceable tips. For precision work on laminates, MDF or for quick rounded edges in hard wood. For use on portable Routers or CNC machining centers.

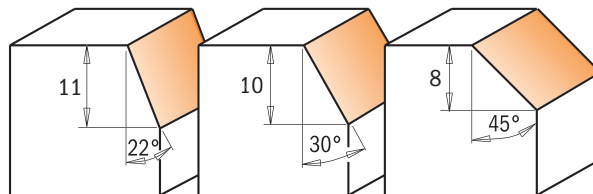

Drawings are 1:1 scale

658



A	D mm	I mm	L mm	ORDER NO. S=Ø6mm	ORDER NO. S=Ø6,35mm	ORDER NO. S=Ø8mm	ORDER NO. S=Ø12,7mm	Spare parts		
45°	29	8	52	658.047.11		658.045.11				
22°	25	11	65	659.024.11	659.023.11	659.022.11		790.120.00	990.075.00	791.006.00
30°	28	10	66	659.032.11	659.031.11	659.030.11		790.120.00	990.075.00	791.006.00
45°	29	8	60	659.047.11	659.046.11	659.045.11		790.120.00	990.075.00	791.022.00
45°	29	8	68				659.646.11	790.120.00	990.075.00	791.022.00

- Spare parts**
- 990.400.00 Ø3.2/Ø7mm shield for M3 screw
 - 990.051.00 M3x6mm TCEI screw
 - 991.062.00 2,5mm hex key
 - 991.061.00 T15 Torx key

Chamfer bits

Saw blades

Jig saw blades

Tools with bore & Knives

Router bits & sets

CNC router cutter & chucks

Industrial dowel drills

Bits for hand power tools

Power tools & accessories

Display cabinets & spare parts



7/8/936 - 8/957

CMT chamfer bits can cut clean, accurate bevels and chamfers and are great for edge work or for making perfectly aligned multi-sided containers, boxes and other decorative projects. See illustration below for examples. Can be used for working larger scale projects such as beams and columns with excellent results.

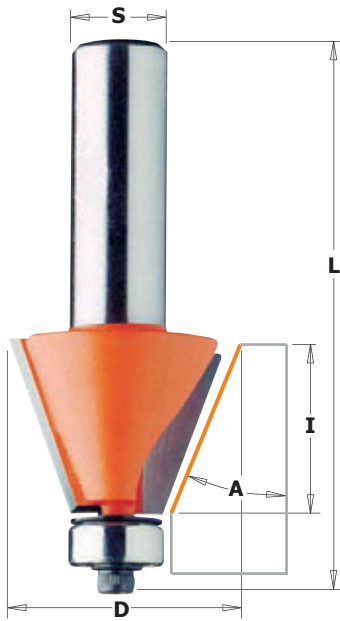

Drawings are 1:1 scale

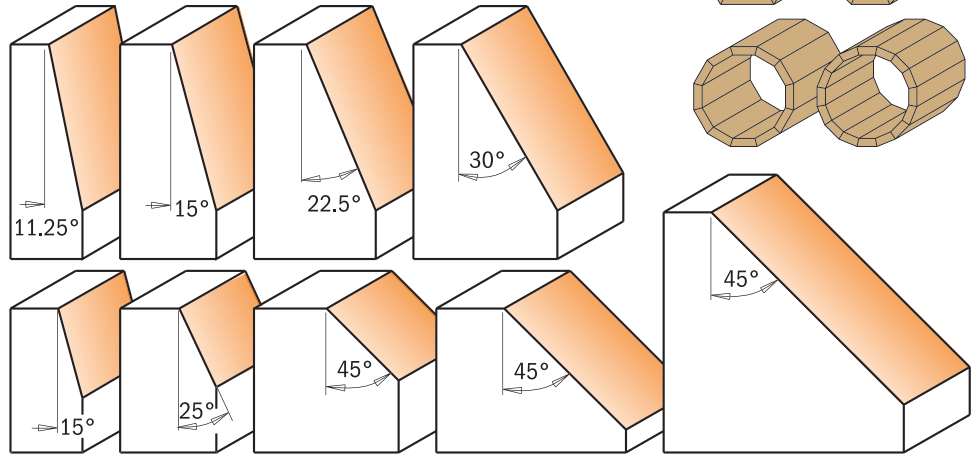

A	D mm	I mm	L mm	ORDER NO. S=Ø6mm	ORDER NO. S=Ø6,35mm	ORDER NO. S=Ø8mm	ORDER NO. S=Ø12mm	ORDER NO. S=Ø12,7mm
15°	19	11,5	54,9	736.130.11	836.130.11	936.130.11		
25°	22,2	10	54,9	736.190.11	836.190.11	936.190.11		
45°	31,7	9,5	53	736.280.11	836.280.11	936.280.11		
45°	45	18	60,2	736.420.11	836.420.11	936.420.11		
45°	45	18	66,5				936.920.11	836.920.11
45°	65	26	76,7				936.950.11	836.950.11
11,25°	21,5	22	71,1				957.504.11	857.504.11
15°	24,5	22	71,1				957.503.11	857.503.11
22,5°	31	22	71,1				957.502.11	857.502.11
30°	38,5	22	71,1				957.501.11	857.501.11

Spare parts

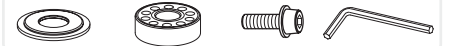

990.423.00	791.003.00	990.058.00	991.057.00
990.423.00	791.003.00	990.058.00	991.057.00
990.423.00	791.003.00	990.058.00	991.057.00
990.423.00	791.003.00	990.058.00	991.057.00
990.423.00	791.003.00	990.058.00	991.057.00
990.423.00	791.003.00	990.058.00	991.057.00
990.423.00	791.003.00	990.058.00	991.057.00
990.423.00	791.003.00	990.058.00	991.057.00
990.423.00	791.003.00	990.058.00	991.057.00
990.423.00	791.003.00	990.058.00	991.057.00

Chamfer set



836

Build beautiful planters, boxes and other multi-sided pieces with this handy set. Why cut imperfect angles on your table saw when it's so much easier and accurate to use the CMT Chamfer set? Our solution to accurate polygon construction includes 5 anti-kickback, carbide tipped bits in the most popular angles - 11-1/4°, 15°, 22-1/2°, 30° and 45°. No polygon project is too difficult. Available with 12,7mm shank.

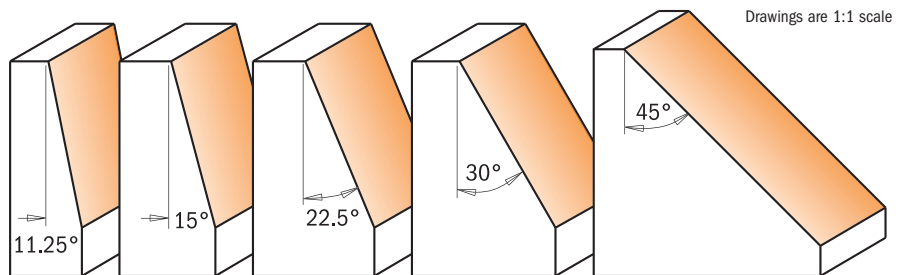

DESCRIPTION	ORDER NO. S=Ø12,7mm
Chamfer set	836.501.11

Round nose bits

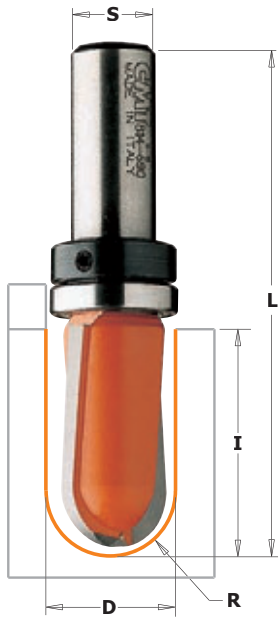

7/8/914B



7/8/914



new



Personalize your doors, drawer fronts, panels or any surface you choose with your own signature motif. CMT round nose bits in solid carbide or with carbide tipped flutes let you create engraving in any wood or wood product. We offer a complete selection of diameters and cutting depths so you can achieve the effects you want. Mounted on your router table, you can work materials up to 31,7mm in depth.

For even more elaborate decorations, we also offer top bearing bits - use your own template with one of these bits to produce truly unique doors and drawer fronts. A favourite item for professional sign makers, craft makers and hobbyists.

SHOP TIPS: more than one pass is recommended when making cove edges. To prevent splintering, begin with a shallow initial pass and deepen gradually.

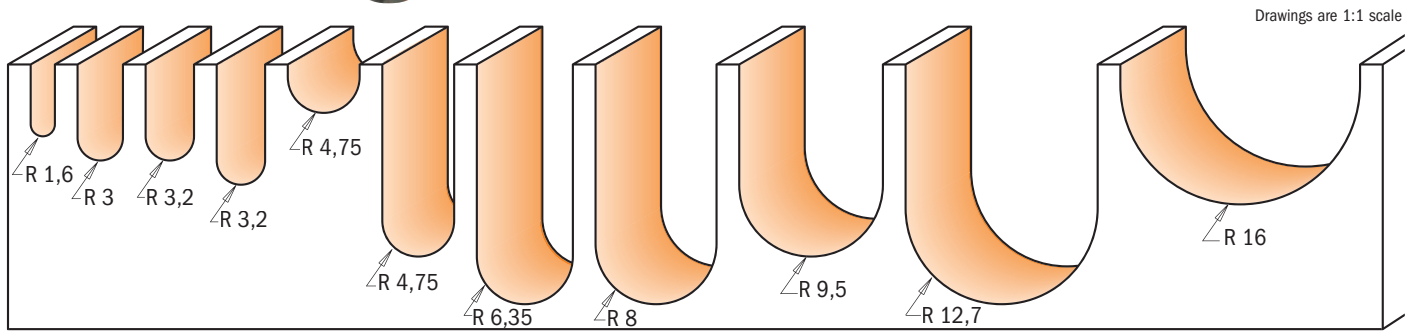

	R	D	I	L	ORDER NO.	ORDER NO.	ORDER NO.	ORDER NO.	ORDER NO.	Spare parts
	mm	mm	mm	mm	S=Ø6mm	S=Ø6,35mm	S=Ø8mm	S=Ø12mm	S=Ø12,7mm	
	• 1,6	3,2	9,5	50,8	714.032.11	814.032.11	914.032.11			
new	• 1,6	3,2	12,7	50,8		199.001.11				
	• 3	6	12,7	50,8	714.060.11		914.060.11			
new	• 3	6	27	70	199.060.11					
	• 3,2	6,4	12,7	50,8		814.064.11				
new	• 3,2	6,4	25,4	63,5		199.008.11				
	• 3,2	6,4	15,9	63,5					814.564.11	
new	• 4	8	32	80			199.081.11			
	4,75	9,5	6,4	50,8	714.095.11	814.095.11	914.095.11			
	4,75	9,5	25,4	66,7					814.595.11	
new	• 6	12	35	80				199.120.11		
	6,35	12,7	9,5	50,8	714.127.11	814.127.11	914.127.11			
	6,35	12,7	31,7	73				914.627.11	814.627.11	
new	• 6,35	12,7	31,7	76,2					199.505.11	
	8	15,8	9,5	50,8	714.160.11	814.160.11	914.160.11			
	8	15,8	31,7	73					814.660.11	
	9,5	19	11,5	50,8	714.190.11	814.190.11	914.190.11			
new	9,5	19	25	63,5			914.191.11			
	9,5	19	31,7	73				914.690.11	814.690.11	
new	12,7	25,4	16	73			914.254.11			
	12,7	25,4	31,7	73				914.754.11	814.754.11	
	16	31,7	18,5	58,8				914.817.11	814.817.11	
with top bearing										
	6,35	12,7	9,5	50,8		814.127.11B				791.010.00 541.001.00 991.056.00
	8	15,8	9,5	50,8		814.160.11B				791.009.00 541.001.00 991.056.00
	8	15,8	9,5	50,8			914.160.11B			791.025.00 541.004.00 991.056.00
	9,5	19	11,5	50,8	714.190.11B					791.007.00 541.003.00 991.056.00
	9,5	19	11,5	50,8		814.190.11B				791.004.00 541.001.00 991.056.00
	9,5	19	31,7	73				814.690.11B		791.011.00 541.002.00 991.056.00

Spare parts 990.005.00 M3x3mm TSEI screw

• HWM

Ball milling

Saw blades
Jig saw blades
Tools with bore & Knives
Router bits & sets
CNC router cutter & chucks
Industrial dowel drills
Bits for hand power tools
Power tools & accessories
Display cabinets & spare parts



8/968

Cut channels for pipes or cables in one single pass using CMT's ball end bits. Reduce the stress on the bits by cutting a first groove with a straight bit.

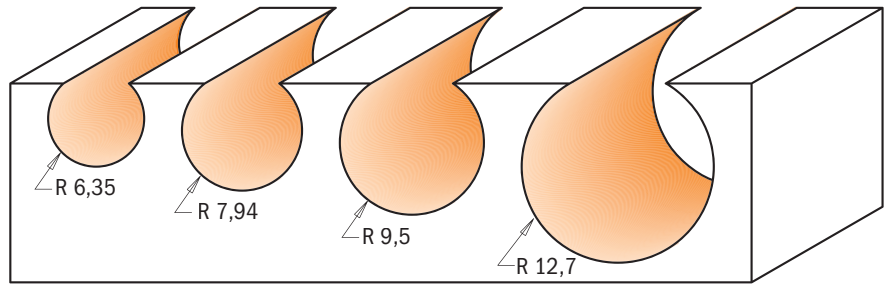

Drawings are 1:1 scale

R mm	D mm	I mm	L mm	ORDER NO. S=Ø8mm	ORDER NO. S=Ø12mm	ORDER NO. S=Ø12,7mm
6,35	12,7	11	57,15	968.127.11		868.627.11
7,94	15,88	14,2	60,3	968.158.11		868.658.11
9,52	19,05	17,4	63,5	968.190.11		868.690.11
12,7	25,4	23,5	70		968.754.11	868.754.11

Round nose set



814

Each of these sets include 3 of the most widely used CMT Round Nose bits. These solid carbide or carbide tipped bits are perfect for sign making, engraving, or adding flutes and veins to doors or drawer fronts. Available in 6,35mm and 12,7mm shanks.



Drawings are 1:1 scale

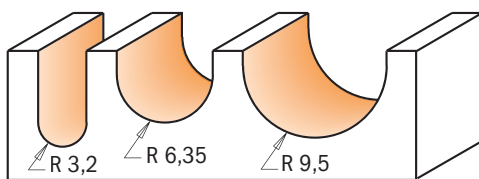

814.001.11

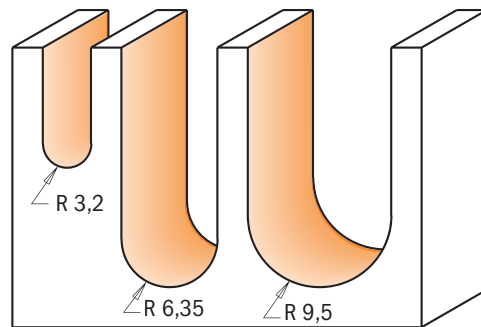

814.501.11

DESCRIPTION	ORDER NO. S=Ø6,35mm	ORDER NO. S=Ø12,7mm
Round nose set	814.001.11	814.501.11

Cove bits

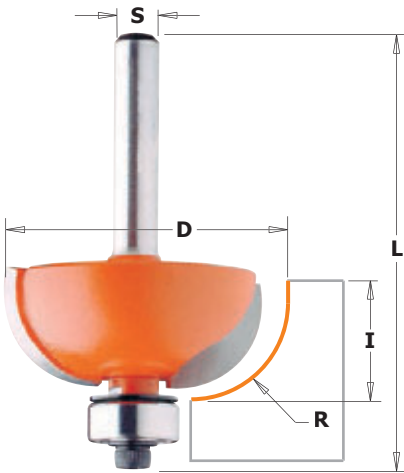

7/8/937



Make simple or elegant furniture, doors and drawer fronts by adding a final touch with CMT cove bits. Join them together with a CMT roundover bit and make perfectly fitting rule joints, ideal for drop leaf counter and table tops. These bits feature anti-kickback design, carbide-tipped cutting edges, Fatigue Proof® steel body and PTFE non-stick coating.

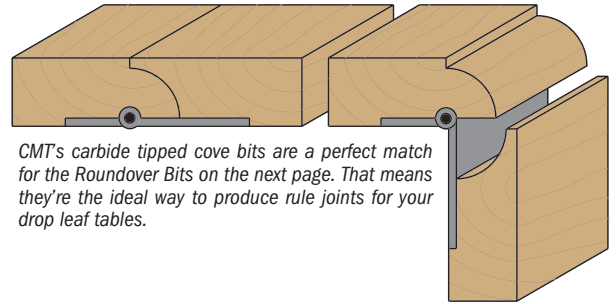

CMT's carbide tipped cove bits are a perfect match for the Roundover Bits on the next page. That means they're the ideal way to produce rule joints for your drop leaf tables.

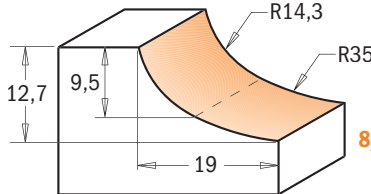

8/937.955.11

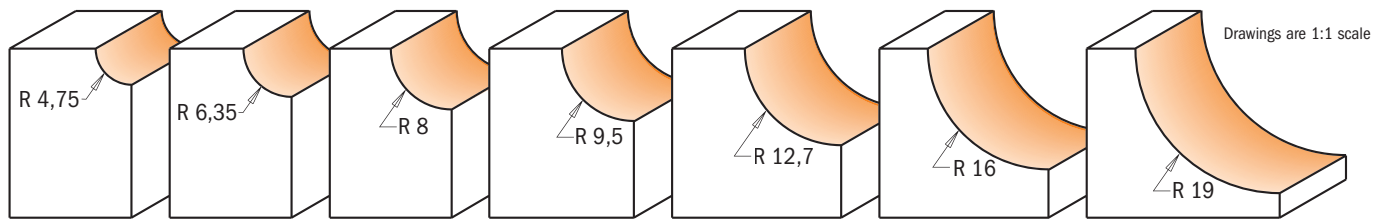

R	D	I	L	ORDER NO.	ORDER NO.	ORDER NO.	ORDER NO.	ORDER NO.
mm	mm	mm	mm	S=Ø6mm	S=Ø6,35mm	S=Ø8mm	S=Ø12mm	S=Ø12,7mm
4,75	22,2	12,7	54,9	737.190.11	837.190.11	937.190.11		
4,75	22,2	12,7	61,2				937.690.11	837.690.11
6,35	25,4	12,7	54,9	737.222.11	837.222.11	937.222.11		
6,35	25,4	12,7	61,2				937.722.11	837.722.11
8	28,7	12,7	54,2	737.254.11	837.254.11	937.254.11		
8	28,7	12,7	60,5				937.754.11	837.754.11
9,5	31,7	12,7	54,2	737.286.11	837.286.11	937.286.11		
9,5	31,7	12,7	60,5				937.786.11	837.786.11
12,7	38,1	15,5	57,7	737.350.11	837.350.11	937.350.11		
12,7	38,1	15,5	64				937.850.11	837.850.11
16	44,5	18,5	67				937.950.11	837.950.11
19	50,8	22,2	70,7				937.951.11	837.951.11
14,3-35	50,8	12,7	61,2				937.955.11	837.955.11

Spare parts



990.423.00	791.003.00	990.058.00	991.057.00
990.423.00	791.003.00	990.058.00	991.057.00
990.423.00	791.003.00	990.058.00	991.057.00
990.423.00	791.003.00	990.058.00	991.057.00
990.423.00	791.003.00	990.058.00	991.057.00
990.423.00	791.003.00	990.058.00	991.057.00
990.423.00	791.003.00	990.058.00	991.057.00
990.423.00	791.003.00	990.058.00	991.057.00
990.423.00	791.003.00	990.058.00	991.057.00
990.423.00	791.003.00	990.058.00	991.057.00
990.423.00	791.003.00	990.058.00	991.057.00
990.423.00	791.003.00	990.058.00	991.057.00
990.423.00	791.003.00	990.058.00	991.057.00
990.423.00	791.003.00	990.058.00	991.057.00
990.423.00	791.003.00	990.058.00	991.057.00
990.423.00	791.003.00	990.058.00	991.057.00
990.423.00	791.003.00	990.058.00	991.057.00
990.423.00	791.003.00	990.058.00	991.057.00
990.423.00	791.003.00	990.058.00	991.057.00
990.423.00	791.003.00	990.058.00	991.057.00
990.423.00	791.003.00	990.058.00	991.057.00

Cove bit set



837



See simple furniture, doors and drawer fronts transform into elegant pieces by giving them a final touch with a CMT Cove Bit. Pair them up with CMT Roundover Bits and make beautiful rule joints to create drop leaf counter and table tops. Anti-kickback design and thick carbide tips for long lasting performance. Available with a 12,7mm or 6,35mm shank. Cove radii are 6,35mm, 9,5mm and 12,7mm.

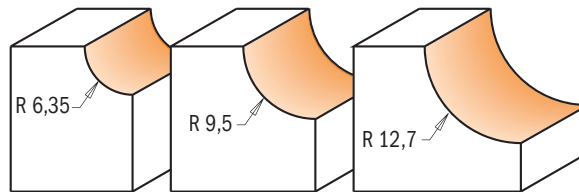

Drawings are 1:1 scale

DESCRIPTION	ORDER NO.	ORDER NO.
	S=Ø6,35mm	S=Ø12,7mm
Cove bit set	837.001.11	837.501.11

Cavetto edge mold bits

Saw blades

Jig saw blades

Tools with bore & Knives

Router bits & sets

CNC router cutter & chucks

Industrial dowel drills

Bits for hand power tools

Power tools & accessories

Display cabinets & spare parts



7/8/963 - 7/8/964

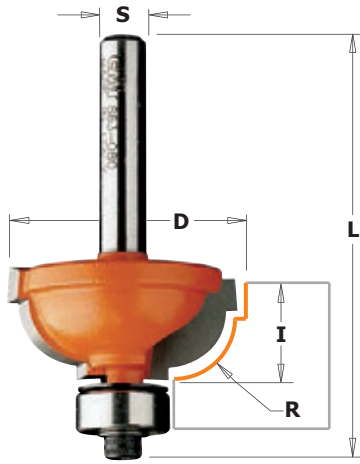

The cavetto bit cuts beautiful, traditional profiles, but you may also use just a portion of the bit to cut a more simple and cleaner cove edge. This bit add a special touch to furniture pieces by making traditional cove profiles with top and bottom fillet grooves in any kind of wood and wood composites.

Important: always assemble the black bearing heat shield with the raised side up when changing the bearing. Improper assembly will cause the screw to come loose and the bearing to fall off when routing.

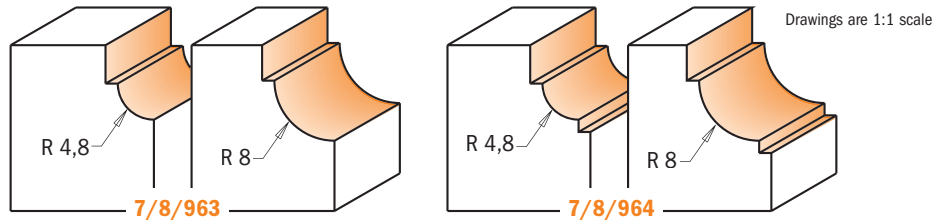

R	D	I	L	ORDER NO.	ORDER NO.	ORDER NO.	ORDER NO.	ORDER NO.	Spare parts
mm	mm	mm	mm	S=Ø6mm	S=Ø6,35mm	S=Ø8mm	S=Ø12mm	S=Ø12,7mm	
4,8	25,4	11,5	54,6	763.048.11	863.048.11	963.048.11			
4,8	25,4	11,5	60,9				963.548.11	863.548.11	
8	31,7	14,3	56,9	763.080.11	863.080.11	963.080.11			
8	31,7	14,3	66,8				963.580.11	863.580.11	
4,8	25,4	11,5	52,8	764.048.11	864.048.11	964.048.11			
4,8	25,4	11,5	59,1				964.548.11	864.548.11	
8	31,7	14,3	55,1	764.080.11	864.080.11	964.080.11			
8	31,7	14,3	65				964.580.11	864.580.11	
									990.423.00 791.003.00 990.058.00 991.057.00
									990.423.00 791.003.00 990.058.00 991.057.00
									990.423.00 791.003.00 990.058.00 991.057.00
									990.423.00 791.003.00 990.058.00 991.057.00
									990.422.00 791.002.00 990.058.00 991.057.00
									990.422.00 791.002.00 990.058.00 991.057.00
									990.422.00 791.002.00 990.058.00 991.057.00
									990.422.00 791.002.00 990.058.00 991.057.00

Ovolo bits

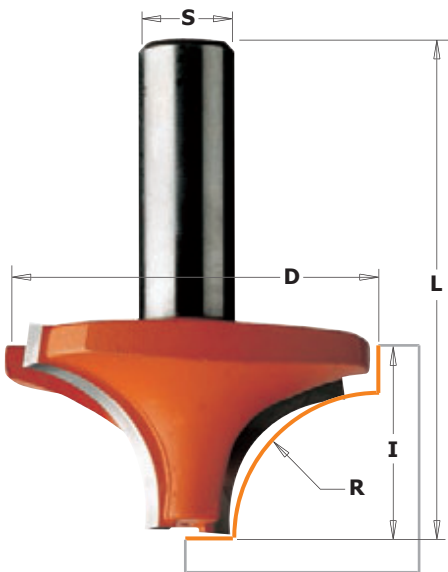

7/8/927



CMT put the work capacity of several different bits all into one. The perfect bit for furniture makers, the CMT ovolo allows you to make beautiful beadwork, edgework and veins. Use these bits on automated router systems or with a fence to produce a wide variety of single and double bead profiles and roundovers like those illustrated below by simply adjusting the height or depth of the cut.

SAFETY TIPS: Pay particular attention to never rush the job when using a large profile bit. Mill pieces with a fence mounted on the work table to insure maximum protection.

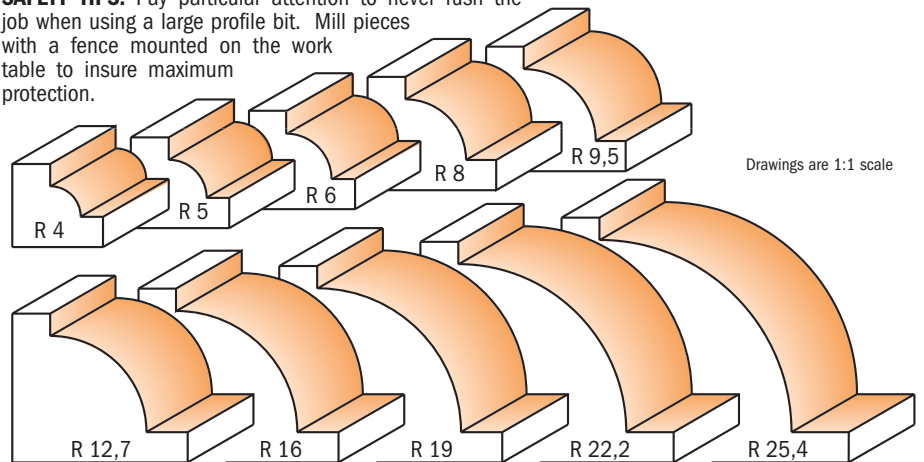

R	D	I	L	ORDER NO.	ORDER NO.	ORDER NO.	ORDER NO.	ORDER NO.
mm	mm	mm	mm	S=Ø6mm	S=Ø6,35mm	S=Ø8mm	S=Ø12mm	S=Ø12,7mm
4	19	12	43,8	727.040.11		927.040.11		
5	21	12	43,8	727.050.11	827.050.11	927.050.11		
6	23	12	43,8	727.060.11	827.060.11	927.060.11		
6	23	12	50,1					827.560.11
8	28,6	12,7	44,5	727.080.11		927.080.11		
9,5	31,7	14	45,8	727.095.11	827.095.11	927.095.11		
9,5	31,7	14	51,9				927.595.11	827.595.11
12,7	38,1	19	50,8		827.127.11			
12,7	38,1	19	57,1				927.627.11	827.627.11
16	44,5	22,2	60,3				927.660.11	827.660.11
19	50,8	25,4	63,5				927.690.11	827.690.11
22,2	57,1	28,5	66,6				927.722.11	827.722.11
25,4	63,5	33,3	71,4				927.754.11	827.754.11

Beading bits

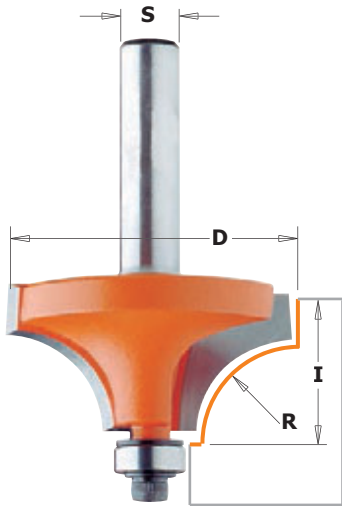

7/8/939



Beading bits are similar to the roundover profile, but a smaller bearing produces a delicate inset at the base of the cut, giving you an extra decorative option.
For a beading profile (code 7/8/939) simply change the bearing (**791.002.00**) on your roundover bits (code 7/8/938).

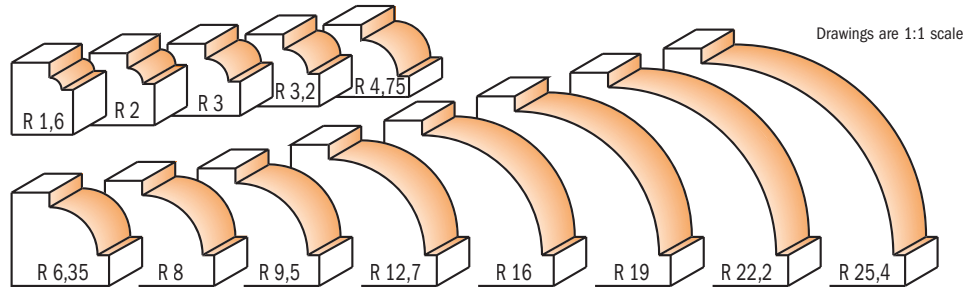

*Use only on router table

R mm	D mm	I mm	ORDER NO. S=Ø6mm	ORDER NO. S=Ø6,35mm	ORDER NO. S=Ø8mm	ORDER NO. S=Ø12mm	ORDER NO. S=Ø12,7mm	Spare parts							
1,6	15,9	12,7	739.160.11	839.160.11	939.160.11							990.422.00	791.002.00	990.058.00	991.057.00
2	16,7	12,7			939.167.11							990.422.00	791.002.00	990.058.00	991.057.00
3	18,7	12,7			939.187.11							990.422.00	791.002.00	990.058.00	991.057.00
3,2	19,1	12,7	739.190.11	839.190.11	939.190.11							990.422.00	791.002.00	990.058.00	991.057.00
4,75	22,2	12,7	739.222.11	839.222.11	939.222.11							990.422.00	791.002.00	990.058.00	991.057.00
6,35	25,4	12,7	739.254.11	839.254.11	939.254.11	939.754.11	839.754.11					990.422.00	791.002.00	990.058.00	991.057.00
8	28,6	12,7	739.285.11	839.285.11	939.285.11							990.422.00	791.002.00	990.058.00	991.057.00
9,5	31,7	16	739.317.11	839.317.11	939.317.11	939.817.11	839.817.11					990.422.00	791.002.00	990.058.00	991.057.00
12,7	38,1	19	739.380.11	839.380.11	939.380.11	939.880.11	839.880.11					990.422.00	791.002.00	990.058.00	991.057.00
16	44,5	22		839.445.11	939.445.11	939.945.11	839.945.11					990.422.00	791.002.00	990.058.00	991.057.00
19	50,8	25,4				939.990.11	839.990.11					990.422.00	791.002.00	990.058.00	991.057.00
22,2	57,1	28,5				939.991.11	839.991.11					990.422.00	791.002.00	990.058.00	991.057.00
25,4	63,5	33,3				939.992.11*	839.992.11*					990.422.00	791.002.00	990.058.00	991.057.00

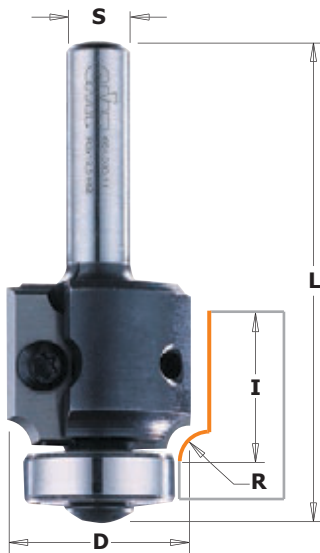

Roundover bits with insert knives

661



Roundover bits with two replaceable knives fixed by special Tox screws. The blades are 2 sided profiled and give high economy of your work with laminates. Roundover bits type are equipped with the ball bearing guides. For precision work on laminates. Radius R2 or R3 is for rounded 2mm or 3mm ABS edges. Radius R5 is for quick rounded edges in hard wood or MDF. For use on portable Routers.

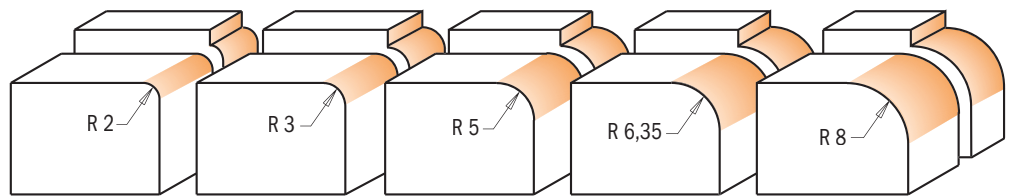

Drawings are 1:1 scale

R mm	D mm	I mm	L mm	ORDER NO. S=Ø6,35mm	ORDER NO. S=Ø8mm	ORDER NO. S=Ø12,7mm	Spare parts							
2	22,8	19,5	64	661.021.11	661.020.11						790.020.00	990.076.00	991.061.00	791.007.00
3	24,8	19,5	64	661.031.11	661.030.11						790.030.00	990.076.00	991.061.00	791.007.00
5	28,8	19,5	64	661.051.11	661.050.11						790.050.00	990.076.00	991.061.00	791.007.00
6,35	28,5	24	67	661.064.11	661.063.11						790.064.00	990.075.00	991.061.00	791.006.00
8	31,8	24	67		661.080.11						790.080.00	990.075.00	991.061.00	791.006.00
8	31,8	24	77			661.581.11					790.080.00	990.075.00	991.061.00	791.006.00

Spare parts

990.400.00	M3 shield	990.410.00	M4 shield
990.051.00	M3x6mm TCEI screw	990.052.00	M4x6mm TCEI screw
991.062.00	2,5mm hex key	991.067.00	3mm hex key

Roundover bits



7/8/938

The smaller bearing on the CMT Beading bits makes a delicate inset at the base of the cut, giving you the advantage of an extra decorative option.

BE SURE to keep the black bearing washer right side up to correspond with the bearing rotation when reassembling the bearing. Improper reassembly can cause the bit to unscrew. All CMT roundover bits have a 12,7mm bearing diameter with the exception of the radius 28,6mm and 31,7mm bits which have a 19mm bearing diameter. You have 13 different radii to choose from, the majority having 5 shank diameter options. All bits are made of Fatigue Proof® steel and have carbide-tipped cutting edges.

SHOP TIPS: The CMT 1.6mm radius roundover bit is excellent for finishing laminates. Virtually eliminates the filing required when using conventional trim bits.

SAFETY TIPS: Use caution when working with large diameter bits and make more than one pass to gradually remove stock. Pay particular attention when routing small pieces; and always rout on a router table equipped with a fence.

***Use only on router table**

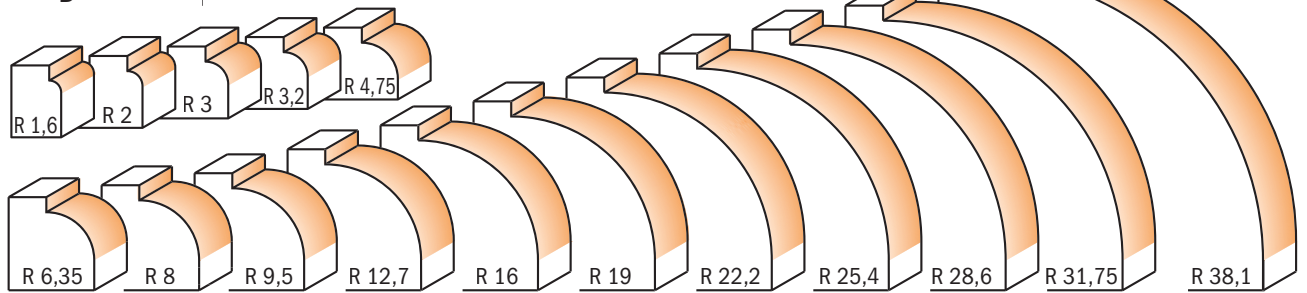
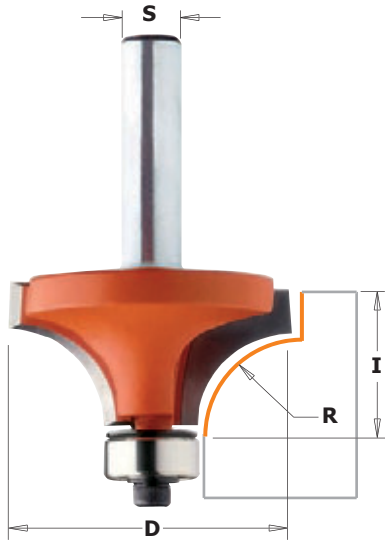

Drawings are 1:1 scale

Spare parts



R mm	D mm	I mm	ORDER NO. S=Ø6mm	ORDER NO. S=Ø6,35mm	ORDER NO. S=Ø8mm	ORDER NO. S=Ø12mm	ORDER NO. S=Ø12,7mm				
1,6	15,9	12,7	738.160.11	838.160.11	938.160.11			990.423.00	791.003.00	990.058.00	991.057.00
2	16,7	12,7	738.167.11°		938.167.11°			990.422.00	791.044.00	990.058.00	991.057.00
3	18,7	12,7	738.187.11°		938.187.11°			990.422.00	791.044.00	990.058.00	991.057.00
3,2	19,1	12,7	738.190.11	838.190.11	938.190.11			990.423.00	791.003.00	990.058.00	991.057.00
4,75	22,2	12,7	738.222.11	838.222.11	938.222.11			990.423.00	791.003.00	990.058.00	991.057.00
6,35	25,4	12,7	738.254.11	838.254.11	938.254.11	938.754.11	838.754.11	990.423.00	791.003.00	990.058.00	991.057.00
8	28,6	12,7	738.285.11	838.285.11	938.285.11			990.423.00	791.003.00	990.058.00	991.057.00
9,5	31,7	16	738.317.11	838.317.11	938.317.11	938.817.11	838.817.11	990.423.00	791.003.00	990.058.00	991.057.00
12,7	38,1	19	738.380.11	838.380.11	938.380.11	938.880.11	838.880.11	990.423.00	791.003.00	990.058.00	991.057.00
16	44,5	22		838.445.11	938.445.11	938.945.11	838.945.11	990.423.00	791.003.00	990.058.00	991.057.00
19	50,8	25,4				938.990.11	838.990.11	990.423.00	791.003.00	990.058.00	991.057.00
22,2	57,1	28,5				938.991.11	838.991.11	990.423.00	791.003.00	990.058.00	991.057.00
25,4	63,5	33,3				938.992.11*	838.992.11*	990.423.00	791.003.00	990.058.00	991.057.00
28,6	76,2	38,1				938.993.11*	838.993.11*	541.550.00	791.004.00	990.058.00	991.057.00
31,75	82,5	44,4				938.994.11*	838.994.11*	541.550.00	791.004.00	990.058.00	991.057.00
38,1	88,9	44,4				938.996.11*	838.996.11*	990.423.00	791.003.00	990.058.00	991.057.00

* 791.044.00 Delrin® Bearing

Roundover set



838

CMT's roundover sets give you the maximum flexibility for all of your projects by putting the most requested diameters in one package. Available in 12,7mm and 6,35mm shanks. Roundover radii are 6,35mm, 9,5mm and 12,7mm. These versatile bits are always in demand - the simple clean lines of a smooth roundover edge can be used in a wide variety of applications from picture frames to table and counter tops.

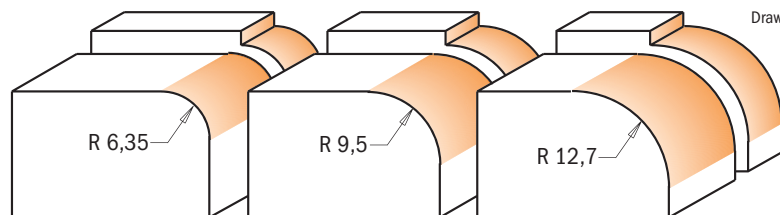

Drawings are 1:1 scale

DESCRIPTION	ORDER NO. S=Ø6,35mm	ORDER NO. S=Ø12,7mm
Roundover set	838.001.11	838.501.11

Saw blades
Jig saw blades
Tools with bore & Knives
Router bits & sets
CNC router cutter & chucks
Industrial dowel drills
Bits for hand power tools
Power tools & accessories
Display cabinets & spare parts

Decorative ogee bits

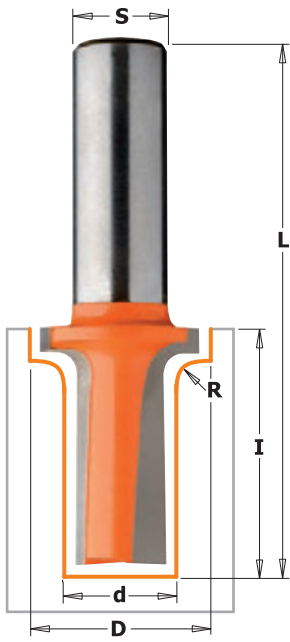

8/965.905



8/965.903
8/965.904

8/965

Enhance your doors and drawer fronts and leave your visitors amazed! These ogee bits cutting edges are carbide-tipped for effective, smooth and eye-catching work.

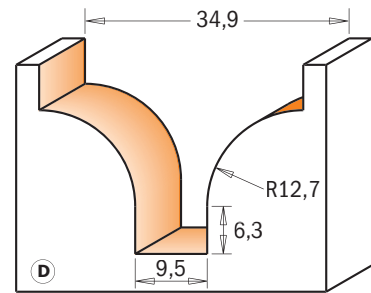
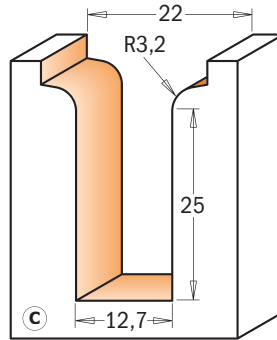
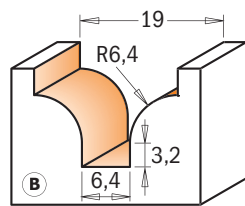

Drawings are 1:1 scale

D mm	d mm	R mm	I mm	L mm	Profile	ORDER NO. S=Ø12mm	ORDER NO. S=Ø12,7mm
19	6,4	6,4	13	51	B	965.903.11	865.903.11
22	12,7	3,2	31,7	69,8	C	965.905.11	865.905.11
34,9	9,5	12,7	25	65,5	D	965.904.11	865.904.11

new

Decorative ogee bits

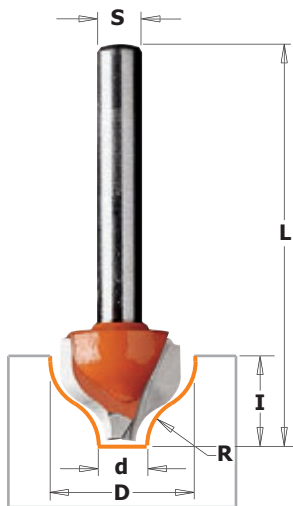

7/8/965

This new CMT bit produces a classic single or double edged bead. Ideal for creating a marked decorative effect on panel, door and drawer work.

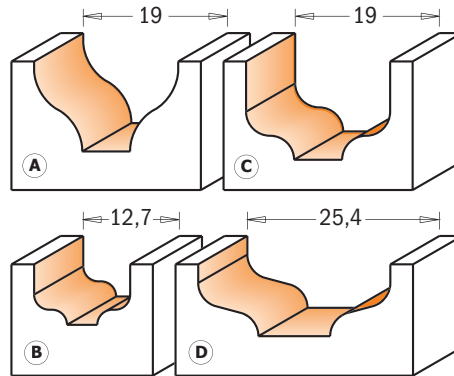

Drawings are 1:1 scale

D mm	d mm	R mm	I mm	L mm	Profile	ORDER NO. S=Ø6mm	ORDER NO. S=Ø6,35mm	ORDER NO. S=Ø8mm	ORDER NO. S=Ø12mm	ORDER NO. S=Ø12,7mm
19	6,35	6,4	11	50,8	A	765.001.11	865.001.11	965.001.11	965.501.11	865.501.11
12,7	4	2	8	51	B		865.002.11	965.002.11		
19	6,35	3,2	13	68	C				965.503.11	865.503.11
25,4	9,5	3,2	9,5	49	D				965.504.11	865.504.11

Decorative ogee bits

Saw blades

Jig saw blades

Tools with bore & Knives

Router bits & sets

CNC router cutter & chucks

Industrial dowel drills

Bits for hand power tools

Power tools & accessories

Display cabinets & spare parts



7/8/965

Make subtle decorative edges with this bit! Perfect for enhancing doors and drawer fronts, it will deliver smooth and flawless results. Carbide-tipped to ensure a clean, sharp and precise cut.

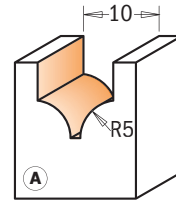

Drawing is 1:1 scale

D mm	d mm	R mm	I mm	L mm	Profile	ORDER NO. S=Ø6mm	ORDER NO. S=Ø6,35mm	ORDER NO. S=Ø8mm
10	1,3	5	10	50	A	765.402.11	865.402.11	965.402.11

Classical bead bits

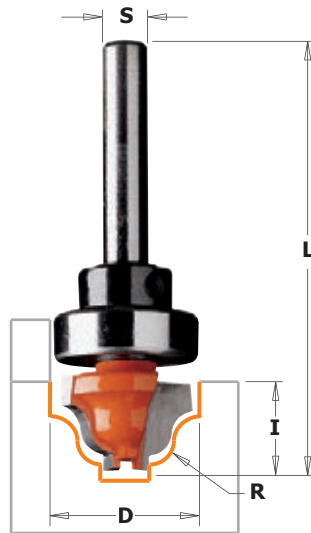

7/8/965B

This bit gives you even more decorative possibilities for panel and edge work. The bit design gives a wide flat bottom cut and a longer shank allows for a greater depth in the detail of the profile.

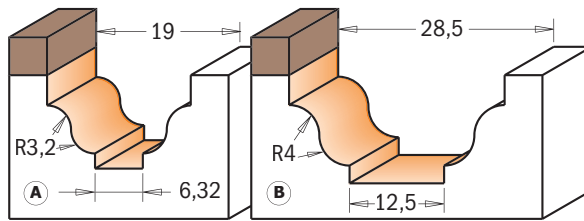

Drawings are 1:1 scale

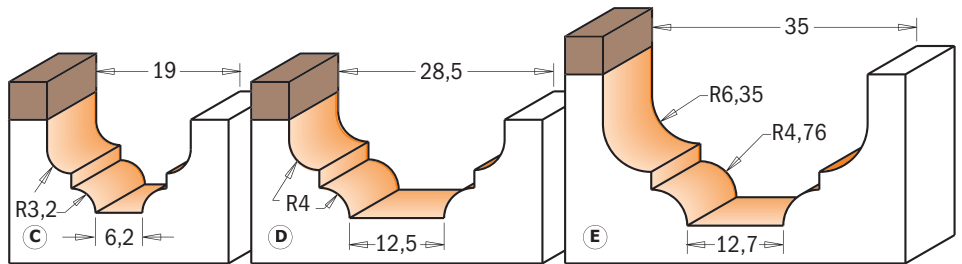

D mm	R mm	I mm	L mm	Profile	ORDER NO. S=Ø6mm	ORDER NO. S=Ø6,35mm	ORDER NO. S=Ø8mm	ORDER NO. S=Ø12mm	ORDER NO. S=Ø12,7mm	Spare parts		
19	3,2	12,3	54	A	765.201.11B							
19	3,2	12,3	54	A		865.201.11B				791.007.00	541.003.00	991.056.00
28,6	4	14,3	58,8	B			965.202.11B			791.004.00	541.001.00	991.056.00
28,6	4	14,3	58,8	B				965.702.11B		791.027.00	541.002.00	991.056.00
28,6	4	14,3	58,8	B					865.702.11B	791.027.00	541.005.00	991.056.00
19	3,2	12,3	54	C	765.301.11B					791.027.00	541.002.00	991.056.00
19	3,2	12,3	54	C		865.301.11B				791.007.00	541.003.00	991.056.00
28,6	4	13,3	58	D			965.302.11B		865.802.11B	791.004.00	541.001.00	991.056.00
28,6	4	13,3	58	D				965.802.11B		791.027.00	541.002.00	991.056.00
34,9	4,76 - 6,35	18,5	66,1	E			965.303.11B			791.027.00	541.005.00	991.056.00
34,9	4,76 - 6,35	18,5	66,1	E					865.803.11B	791.031.00	541.004.00	991.056.00
										791.029.00	541.002.00	991.056.00

Spare parts 990.005.00 M3x3mm TSEI screw

Plunge ogee bits

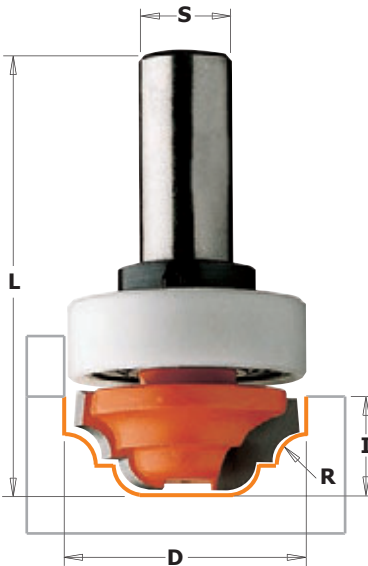

7/8/948 - 7/8/948B



You will never run out of ideas with this creative bit. Add a classic touch to any edge or highlight door fronts and panels with decorative layered effects. For even more options, try the CMT plunge ogee with bearing guide for pattern following.

For more CMT ogee profile options, choose among plunge ogee bits equipped with top bearing. Excellent for achieving accurate decorative work and guaranteed for long lasting performance.

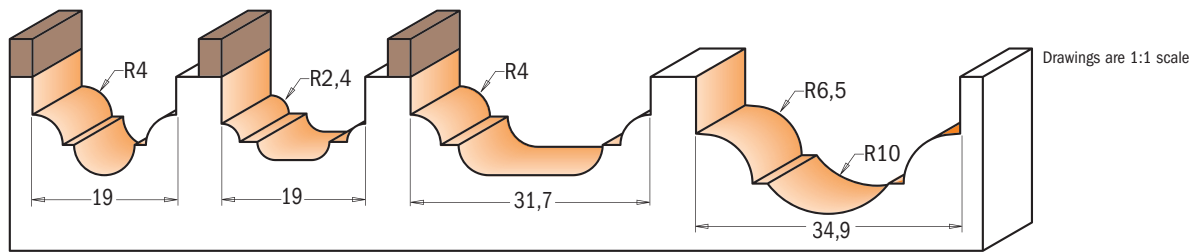

Drawings are 1:1 scale

D mm	R mm	I mm	L mm	ORDER NO. S=Ø6mm	ORDER NO. S=Ø6,35mm	ORDER NO. S=Ø8mm	ORDER NO. S=Ø12mm	ORDER NO. S=Ø12,7mm	Spare parts		
19	4	13	51,1	748.190.11	848.190.11	948.190.11					
19	2,4	12	53	748.191.11	848.191.11	948.191.11					
31,7	4	13	58			948.317.11	948.817.11	848.817.11			
34,9	6,5-10	18	68				948.850.11	848.850.11			
with top bearing											
19	4	13	51,1	748.190.11B					791.007.00	541.003.00	991.056.00
19	4	13	51,1		848.190.11B				791.004.00	541.001.00	991.056.00
19	2,4	12	53	748.191.11B					791.007.00	541.003.00	991.056.00
19	2,4	12	53		848.191.11B				791.004.00	541.001.00	991.056.00
31,7	4	13	58			948.317.11B			791.015.00	541.002.00	991.056.00
31,7	4	13	58				948.817.11B		791.015.00	541.005.00	991.056.00
31,7	4	13	58					848.817.11B	791.015.00	541.002.00	991.056.00

Spare parts 990.005.00 M3x3mm TSEI screw



Decorative ogee bits

7/8/965



This new CMT bit produces a classic single or double edged bead. Ideal for creating a marked decorative effect on panel, door and drawer work.

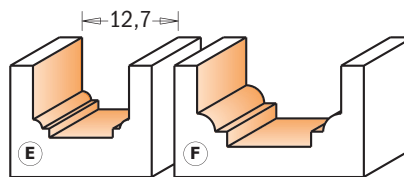

Drawings are 1:1 scale

D mm	d mm	R mm	I mm	L mm	Profile	ORDER NO. S=Ø6mm	ORDER NO. S=Ø6,35mm	ORDER NO. S=Ø8mm		
12,7	8,4	1,2	12,7	50,8	E	765.101.11	865.101.11	965.101.11		
19	11,1	2,4	11	50,8	F	765.102.11	865.102.11	965.102.11		

Roman ogee bits

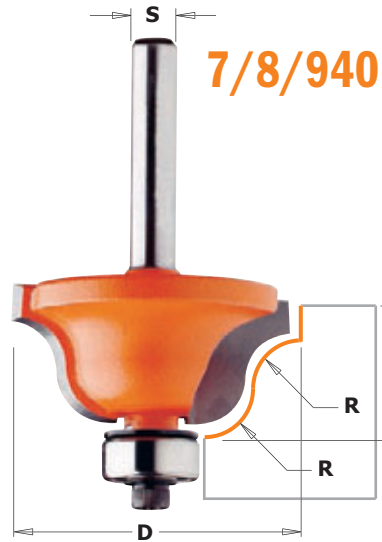

The roman ogee may be the most popular edge treatment in woodworking, and it is certainly one of the most beautiful. This bit includes all CMT bit features and produces a perfect rendition of classic design.
SHOP TIPS: for best results, multiple passes are recommended.

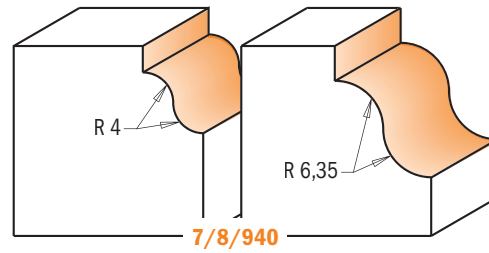

Drawings are 1:1 scale

7/8/941

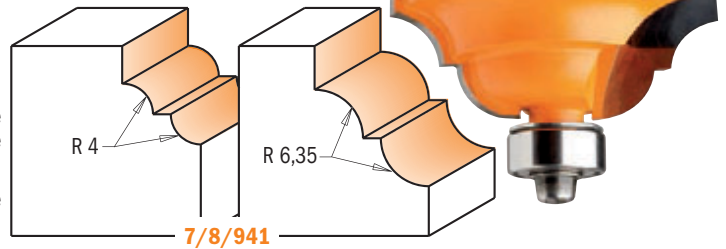

This bit takes the Roman ogee a step further. The horizontal bead adds style and elegance to the traditional shape.

SHOP TIPS: for best results, multiple passes are recommended.

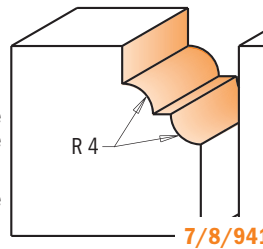

7/8/941

Spare parts

R mm	D mm	I mm	ORDER NO. S=Ø6mm	ORDER NO. S=Ø6,35mm	ORDER NO. S=Ø8mm	ORDER NO. S=Ø12mm	ORDER NO. S=Ø12,7mm				
4	28,7	11,5	740.270.11	840.270.11	940.270.11	940.770.11	840.770.11	990.423.00	791.003.00	990.058.00	991.057.00
6,4	38,1	17,3	740.350.11	840.350.11	940.350.11	940.850.11	840.850.11	990.423.00	791.003.00	990.058.00	991.057.00
4	33,4	13	741.285.11	841.285.11	941.285.11	941.785.11	841.785.11	990.423.00	791.003.00	990.058.00	991.057.00
6,4	42,8	18,5	741.380.11	841.380.11	941.380.11	941.880.11	841.880.11	990.423.00	791.003.00	990.058.00	991.057.00

Classical ogee bits

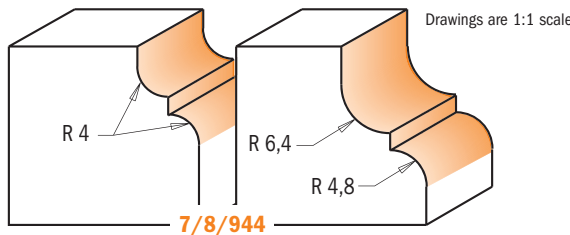
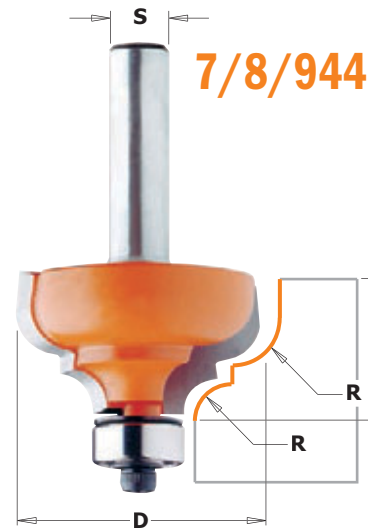

Drawings are 1:1 scale

7/8/945

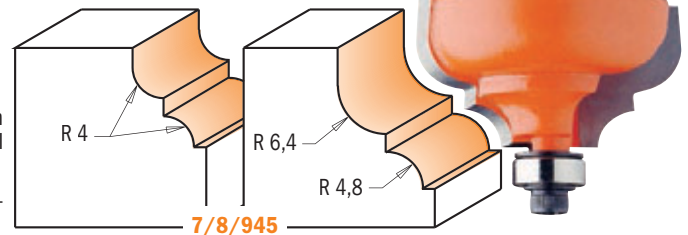

This profile includes a horizontal bead along the bottom of the profile adding a decorative detail to the traditional ogee design.

SHOP TIPS: for best results, multiple passes are recommended.

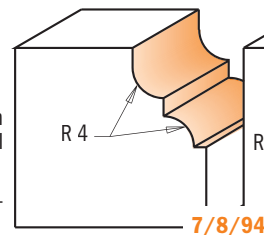

7/8/945

Spare parts

R mm	D mm	I mm	ORDER NO. S=Ø6mm	ORDER NO. S=Ø6,35mm	ORDER NO. S=Ø8mm	ORDER NO. S=Ø12mm	ORDER NO. S=Ø12,7mm				
4	28,7	13	744.287.11	844.287.11	944.287.11	944.787.11	844.787.11	990.423.00	791.003.00	990.058.00	991.057.00
6,4-4,8	35	18,5	744.350.11	844.350.11	944.350.11	944.850.11	844.850.11	990.423.00	791.003.00	990.058.00	991.057.00
4	28,7	13	745.287.11	845.287.11	945.287.11	945.787.11	845.787.11	990.422.00	791.002.00	990.058.00	991.057.00
6,4-4,8	35	18,5	745.350.11	845.350.11	945.350.11	945.850.11	845.850.11	990.422.00	791.002.00	990.058.00	991.057.00

Saw blades
Jig saw blades
Tools with bore & Knives
Router bits & sets
CNC router cutter & chucks
Industrial dowel drills
Bits for hand power tools
Power tools & accessories
Display cabinets & spare parts

Ogee with fillet bits

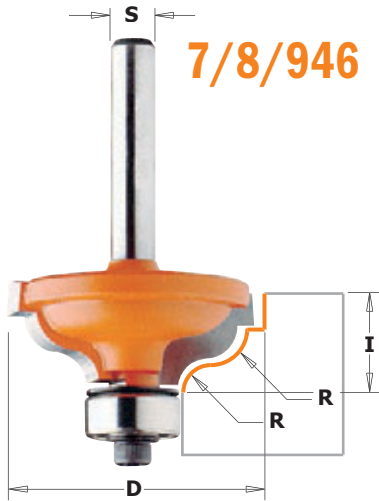

7/8/946

Take a complete assortment of CMT ogee bits into your shop. These bits feature micrograin carbide edges, high strength steel and the trademarked orange non-stick PTFE coating.

SHOP TIPS: for best results, multiple passes are recommended.

For a more-detailed profile, this bit adds an inset bead along the lower edge of the cut.

SHOP TIPS: for best results, multiple passes are recommended.

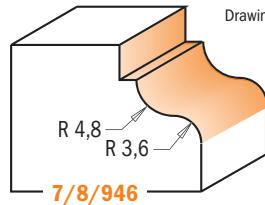

7/8/946

Drawings are 1:1 scale

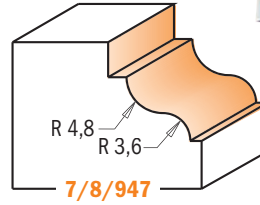

7/8/947

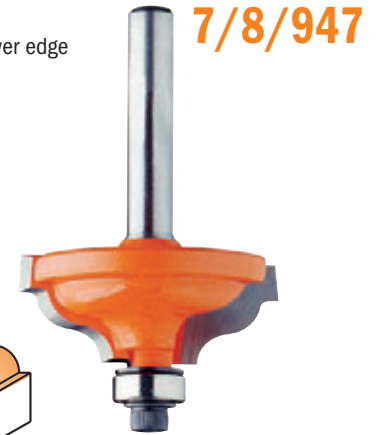

7/8/947

R mm	D mm	I mm	ORDER NO. S=Ø6mm	ORDER NO. S=Ø6,35mm	ORDER NO. S=Ø8mm	ORDER NO. S=Ø12mm	ORDER NO. S=Ø12,7mm
4,8-3,6	34,2	13	746.325.11	846.325.11	946.325.11	946.825.11	846.825.11
4,8-3,6	34,2	13	747.325.11	847.325.11	947.325.11	947.825.11	847.825.11

Spare parts

990.423.00	791.003.00	990.058.00	991.057.00
990.422.00	791.002.00	990.058.00	991.057.00

Ogee bits



7/8/959

These profiles are the mirror image of the traditional roman ogee. They add a sharp defining details to the edges of cabinets and furniture, before rolling into a smooth convex shape.

SHOP TIPS: for best results, multiple passes are recommended.

These bits are identical to the 7/8/959 series with the addition of an inset bead along the lower edge.

SHOP TIPS: for best results, multiple passes are recommended.

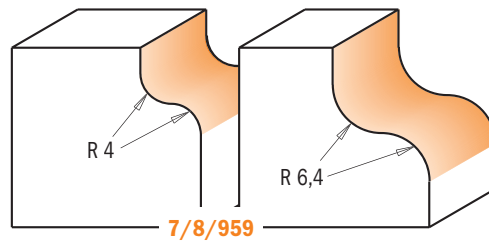

7/8/959

Drawings are 1:1 scale

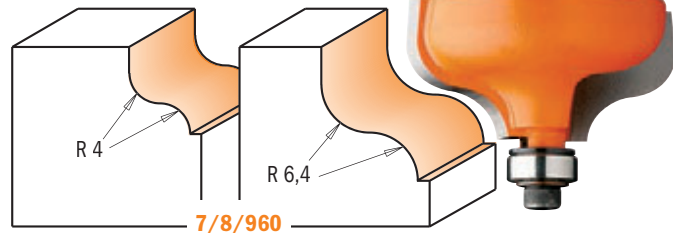

7/8/960

R mm	D mm	I mm	ORDER NO. S=Ø6mm	ORDER NO. S=Ø6,35mm	ORDER NO. S=Ø8mm	ORDER NO. S=Ø12mm	ORDER NO. S=Ø12,7mm
4	28,7	13	759.040.11	859.040.11	959.040.11	959.540.11	859.540.11
6,4	38,1	18	759.064.11	859.064.11	959.064.11	959.564.11	859.564.11
4	28,7	13	760.040.11	860.040.11	960.040.11	960.540.11	860.540.11
6,4	38,1	18	760.064.11	860.064.11	960.064.11	960.564.11	860.564.11

Spare parts

990.423.00	791.003.00	990.058.00	991.057.00
990.423.00	791.003.00	990.058.00	991.057.00
990.422.00	791.002.00	990.058.00	991.057.00
990.422.00	791.002.00	990.058.00	991.057.00

new

CMT ORANGE TOOLS™



Adjustable roundover and bevel router bits

8/900.623

These new CMT bits are ideal for making new awesome creations! Create a double 4,76mm (3/16") roundover profile, a double 45° bevel or even a mixed profile on your wood panels easily and in a cost-effective way! Interchangeable shims are included to allow for different stock thicknesses according to the board. To be used on table-mounted routers. Avoid using these bits in hand-held power tools.

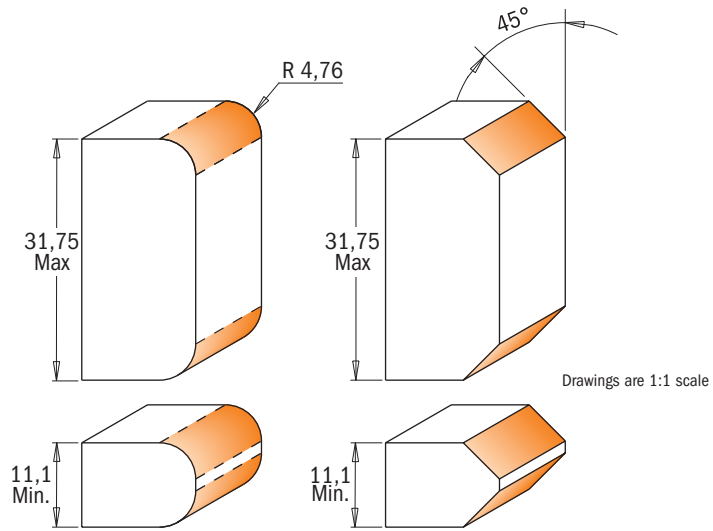
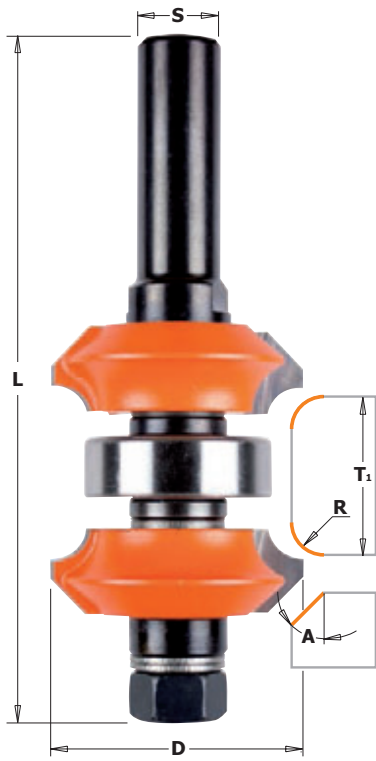

Drawings are 1:1 scale

D mm	T ₁ mm	R mm	A	L mm	ORDER NO. S=Ø12mm	ORDER NO. S=Ø12,7mm
38,1	11,1 - 31,75	4,76	45°	100	900.623.11	
38,1	11,1 - 31,75	4,76	45°	100		800.623.11

Spare parts

924.137.00	791.037.00	822.029.11	822.030.11	990.020.11	
824.137.00	791.037.00	822.029.11	822.030.11	990.020.11	

Spare parts

541.500.00	3mm spacer
541.515.00	0,1mm spacer
541.517.00	0,5mm spacer

541.518.00	1mm spacer
541.519.00	5,8mm spacer

Adjustable double roundover router bits

new



8/900.622

Create awesome furnishing decorations with these new CMT bits! They provide a double 2mm (5/64") and 3mm (1/8") roundover profile on your wood panels easily and in a cost-effective way! Interchangeable shims are included to allow for different stock thicknesses according to the board. To be used on table-mounted routers. Avoid using these bits in hand-held power tools.

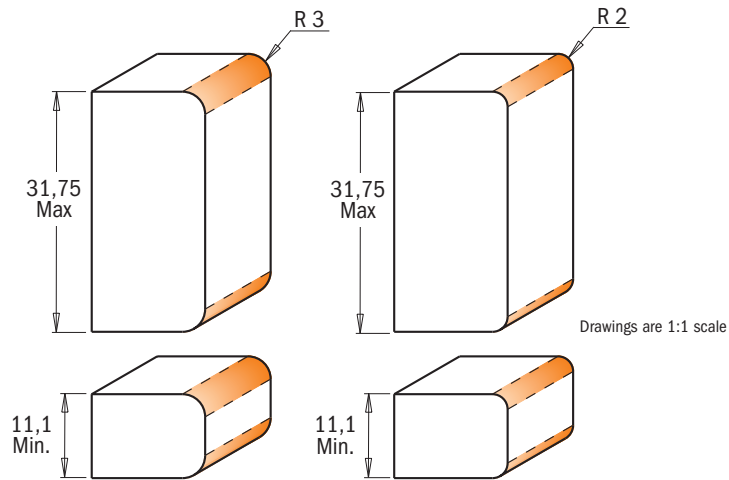
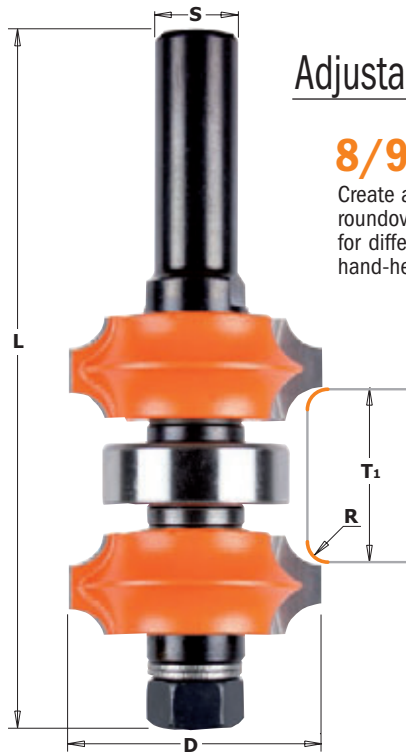

Drawings are 1:1 scale

D mm	T ₁ mm	R mm	L mm	ORDER NO. S=Ø12mm	ORDER NO. S=Ø12,7mm
34	11,1 - 31,75	3 - 2	100	900.622.11	
34	11,1 - 31,75	3 - 2	100		800.622.11

Spare parts

924.137.00	791.037.00	822.031.11	822.032.11	990.020.11	
824.137.00	791.037.00	822.031.11	822.032.11	990.020.11	

Spare parts

541.500.00	3mm spacer
541.501.00	4mm spacer
541.515.00	0,1mm spacer

541.516.00	0,3mm spacer
541.518.00	1mm spacer
541.519.00	5,8mm spacer

Saw blades
Jig saw blades
Tools with bore & Knives
Router bits & sets
CNC router cutter & chucks
Industrial dowel drills
Bits for hand power tools
Power tools & accessories
Display cabinets & spare parts



8/961.6

This new router bit designed for 19mm (3/4") thick stock is perfect for creating wainscots and panels on your walls. Simply create a 6,35mm (1/4") tongue-and-groove interlock with a CMT 8/900.626.11, then, with two passes mill an attractive traditional beadboard profile with this new bit. Perfect for cabinets, bookcase backings, ceiling and wall paneling.

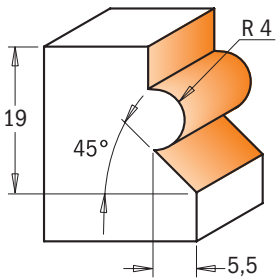
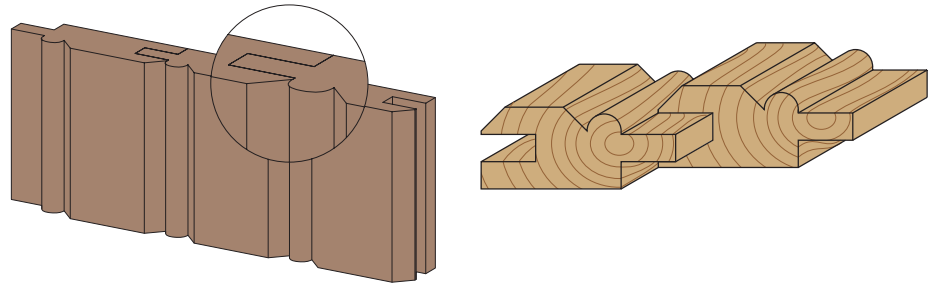
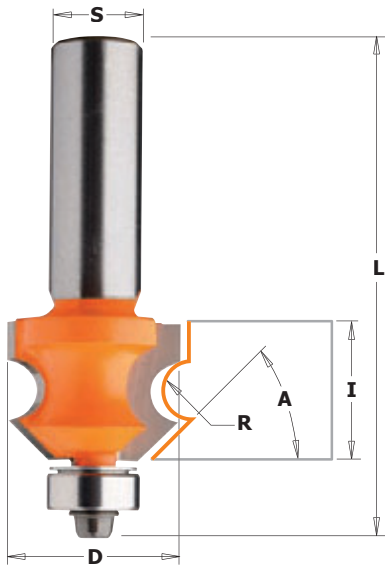

Drawing is 1:1 scale

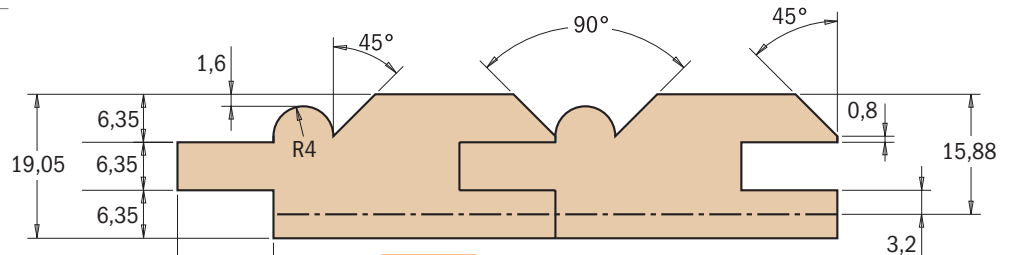

Standard with bearing Ø12,7mm (791.003.00)

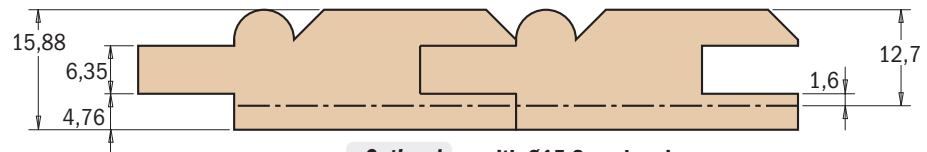

Optional with Ø15,8mm bearing (791.018.00)

Spare parts

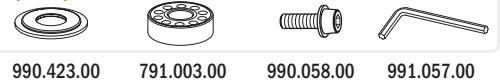

D mm	I mm	R mm	A	L mm	ORDER NO. S=Ø12mm	ORDER NO. S=Ø12,7mm
23,8	19,05	4	45°	67,7	961.601.11	861.601.11

990.423.00	791.003.00	990.058.00	991.057.00
------------	------------	------------	------------

Corner beading bit with 45° chamfer

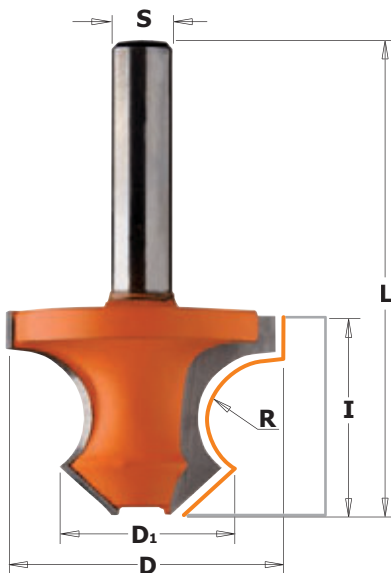

954

An innovative bit to create beautiful edges and corner beads.

SAFETY TIPS: to be used only on CNC machines or router tables equipped with a fence.

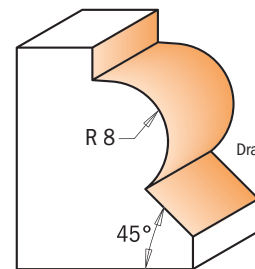

Drawing is 1:1 scale

D mm	D1 mm	I mm	R mm	L mm	ORDER NO. S=Ø8mm
36	22	25	8	60	954.080.11

Bead & bull nose bits

Saw blades
Jig saw blades
Tools with bore & Knives
Router bits & sets
CNC router cutter & chucks
Industrial dowel drills
Bits for hand power tools
Power tools & accessories
Display cabinets & spare parts

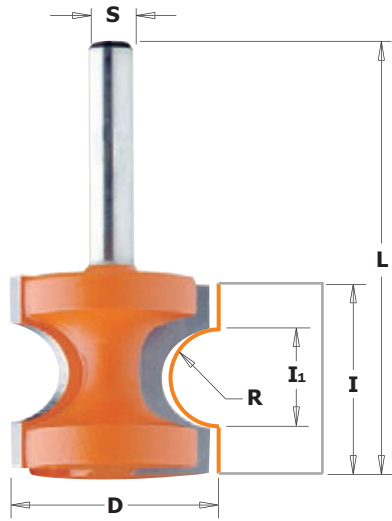

7/8/954



CMT bull nose bits create beautifully finished edges on stair treads, window sills and shelves in a pass. Ad a final touch by using a cutter with a bead diameter wider than the stock thickness. CMT bull nose bits have bead diameters from 6,35mm (1/4") to 25,4mm (1") and each bit features carbide-tipped cutting edges, anti-kickback design and the orange PTFE non-stick coating trademark.

SAFETY TIPS: to be used only on router tables equipped with a fence. Do not remove the workpiece while the bit is routing.

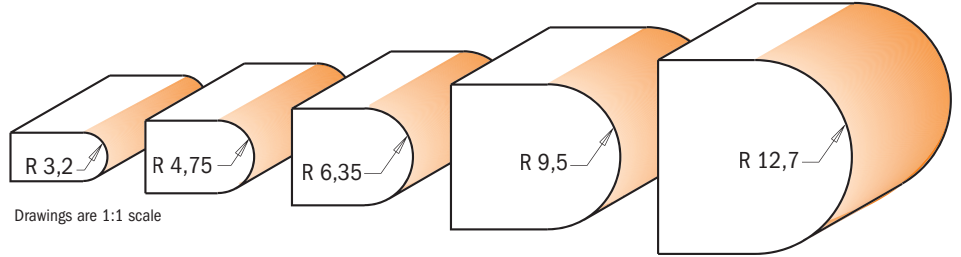

Drawings are 1:1 scale

R	D	I ₁	I	L	ORDER NO. S=Ø6mm	ORDER NO. S=Ø6,35mm	ORDER NO. S=Ø8mm	ORDER NO. S=Ø12mm	ORDER NO. S=Ø12,7mm
3,2	22,2	6,56	19	50,8	754.002.11	854.002.11	954.002.11		
3,2	22,2	6,56	19	57,2				954.502.11	854.502.11
4,75	25,4	9,85	22	54	754.003.11	854.003.11	954.003.11		
4,75	25,4	9,85	22	60,4				954.503.11	854.503.11
6,35	28,6	13,15	25,5	57,2	754.004.11	854.004.11	954.004.11		
6,35	28,6	13,15	25,5	63,5				954.504.11	854.504.11
9,5	34,9	19,71	35	73				954.507.11	854.507.11
12,7	44,5	26,30	41	79,4				954.509.11	854.509.11

Corner beading bits

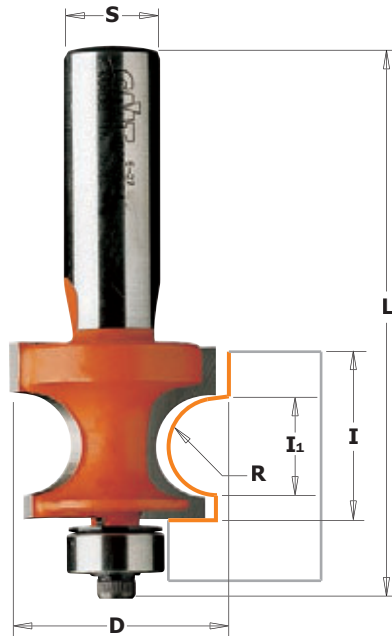

7/8/961



Make beautiful traditional beads and edge beads or turn old beads into new moldings with the new CMT corner beading bits with bearing. Featuring carbide-tipped cutting edges and orange PTFE non-stick coating, these bits provide excellent results on corner beads. Run the bead twice to form a complete corner bead.

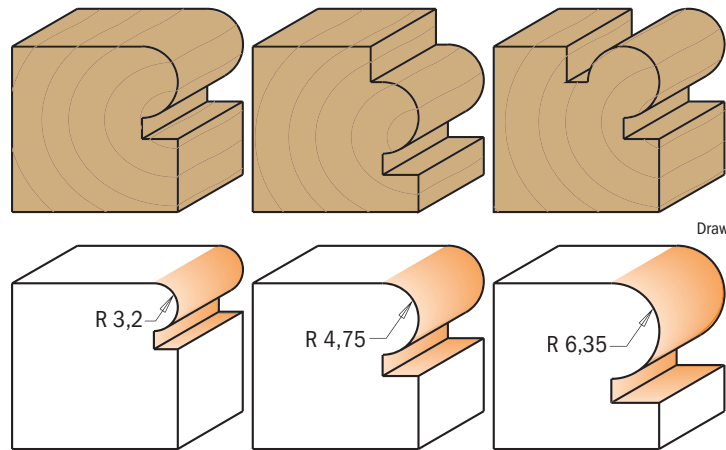

Drawings are 1:1 scale

R	D	I ₁	I	L	ORDER NO. S=Ø6mm	ORDER NO. S=Ø6,35mm	ORDER NO. S=Ø8mm	ORDER NO. S=Ø12mm	ORDER NO. S=Ø12,7mm	Spare parts		
3,2	22,2	6,50	15	57,7	761.032.11	861.032.11	961.032.11					
3,2	22,2	6,50	15	64				961.532.11	861.532.11	990.423.00	791.003.00	990.058.00
4,75	25,4	9,68	18,6	61,2	761.048.11	861.048.11	961.048.11			990.423.00	791.003.00	990.058.00
4,75	25,4	9,68	18,6	67,6				961.548.11	861.548.11	990.423.00	791.003.00	990.058.00
6,35	28,6	12,86	22,2	64,8	761.064.11	861.064.11	961.064.11			990.423.00	791.003.00	990.058.00
6,35	28,6	12,86	22,2	71,7				961.564.11	861.564.11	990.423.00	791.003.00	990.058.00

Spare parts 991.057.00 3/32" hex key

Edge-fluting bits

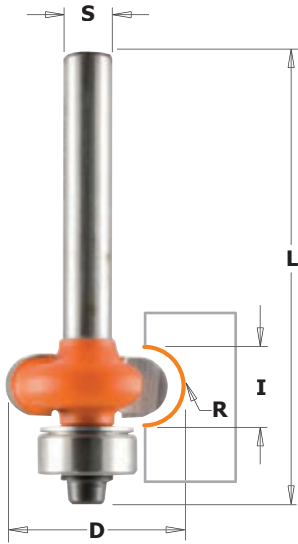

7/862

The edge-fluting bearing guided bits are quick to set up can be used for curved screens, small radius grooves, doors etc. no side fence required. Use in a handheld or table-mounted router.

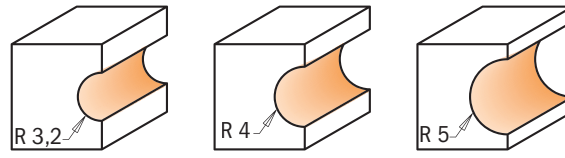

Drawings are 1:1 scale



For Top bearing version: use bearing 791.010.00 and stop collar 541.001.00 (optional)

R mm	D mm	I mm	L mm	ORDER NO. S=Ø6mm	ORDER NO. S=Ø6,35mm	Spare parts				
3,2	19,05	6,4	57	762.032.11	862.032.11					
4	20,7	8	57	762.040.11	862.040.11	990.423.00	791.003.00	990.058.00	991.057.00	
5	22,7	10	57	762.050.11	862.050.11	990.423.00	791.003.00	990.058.00	991.057.00	

CMT Molding system

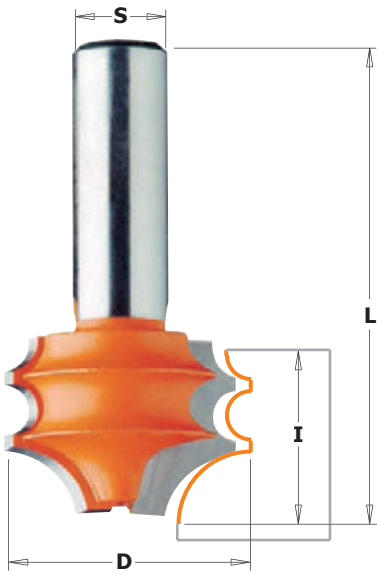

8/956.852

If the standard selection of molding and mill work you find in today's lumber shops isn't satisfactory to your woodworking tastes, then look to CMT's molding system instead. With these bits, you can make dozens of elaborate profiles by combining two or more passes. Avoid the average and create your own moldings. Some initial suggestions are illustrated below.

SAFETY TIPS: use these bits with a fence. The profiles shown below are milled from heavy stock then refined to the desired shape.

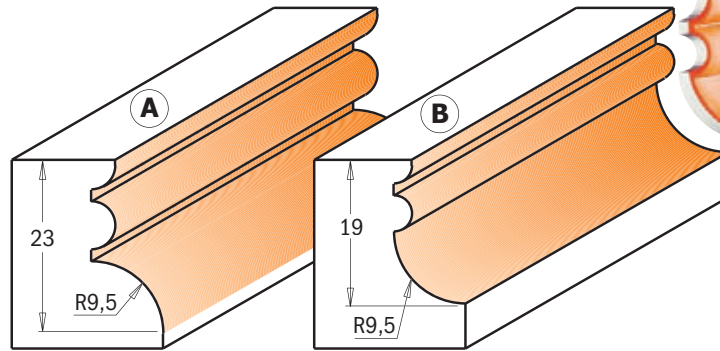

Drawings are 1:1 scale

8/956.851

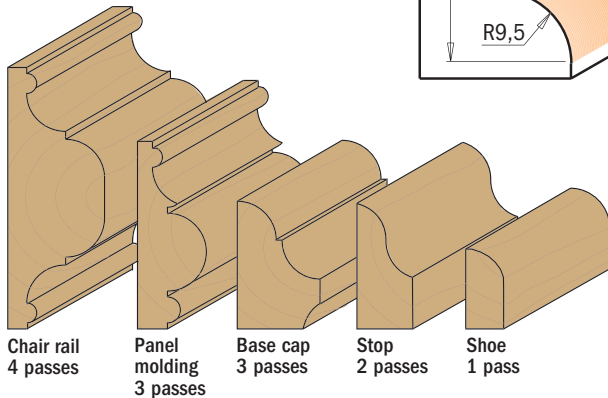

Profile	D mm	I mm	L mm	ORDER NO. S=Ø12mm	ORDER NO. S=Ø12,7mm
A	31,7	23	61,1	956.852.11	856.852.11
B	31,7	19	57,2	956.851.11	856.851.11

Multiprofile bits



8/956.8

Create endless profiles with CMT multiprofile bits. Simply adjust the height of the bit to create classic profiles in one single pass, or make more complex decorative effects in multiple passes. The bits super-strength steel body can withstand long-lasting cutting operations, and the micrograin carbide tips remain sharp longer for superior performance. In addition these bits feature baked-on non-stick PTFE coating and anti-kickback design. To be used on tables equipped with a fence.

SAFETY TIPS: to make small molding as shown below, cut the profile from very wide stock. Remove the excess material and work on the bigger piece to give you easier control. Keep hands far from the bit when working.

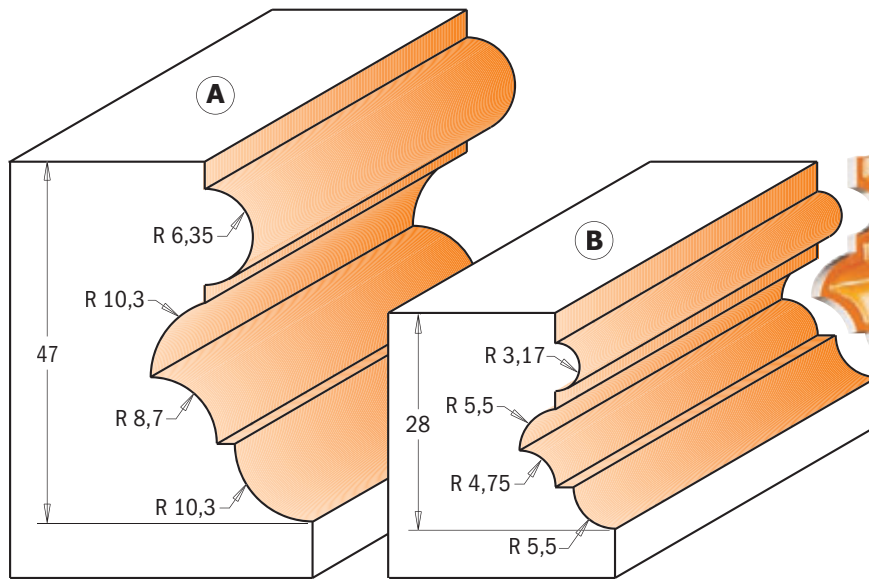
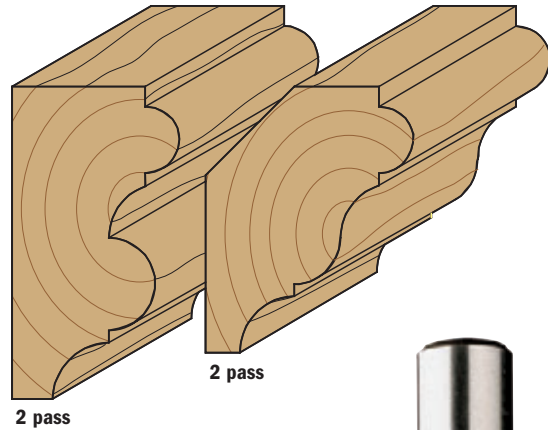
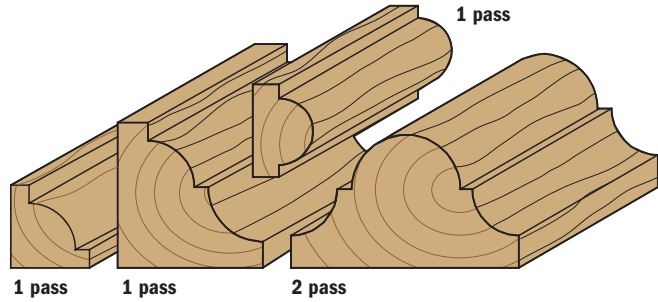
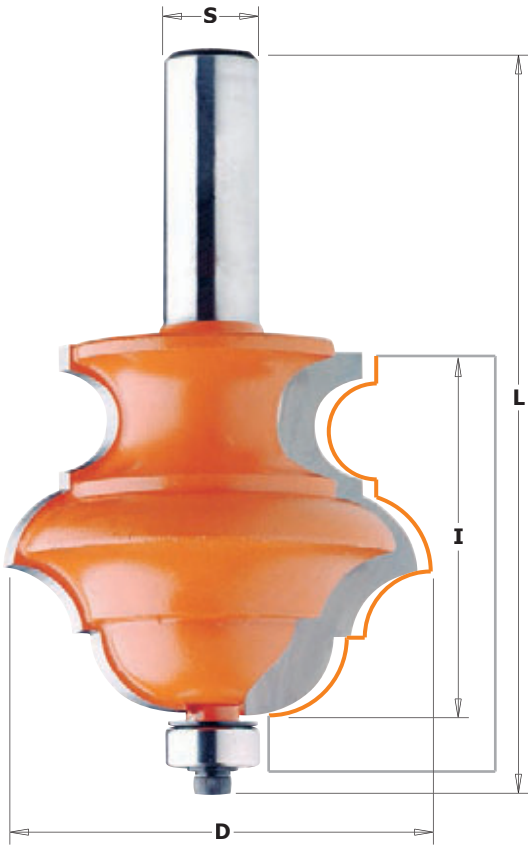

Drawings are 1:1 scale



Profile	D mm	I mm	L mm	ORDER NO. S=Ø12mm	ORDER NO. S=Ø12,7mm	Spare parts							
A	55,6	47	96,4	956.802.11	856.802.11					990.423.00	791.003.00	990.058.00	991.057.00
B	38,1	28	77,5	956.801.11	856.801.11					990.423.00	791.003.00	990.058.00	991.057.00

Molding bits

Why waste time searching for a particular style of frame molding when you can just as quickly and easily make your own. With the wide range of decorative possibilities offered by CMT molding bits, you can always create the edge profile you want, anywhere you want and any time you want. These CMT bits are made to last a lifetime - carbide-tipped cutters and solid bar stock steel shanks can withstand serious use and the baked-on non-stick PTFE coating makes sure you continuously get clean, smooth-running cuts. Our anti-kickback feature helps guarantee you work more safely when using these wide profile bits.

SHOP TIPS: multiple pass operations require advance planning. To avoid making a mistake that could render it impossible to finish the job, carefully consider the entire cutting sequence before you begin.

SAFETY TIPS: all large diameter bits such as these should be used with caution and on router tables equipped with a fence. For best results, 1,7 KW (2-1/4 HP) routers are recommended. Routers as low-powered as 1,1 KW (1-1/2 HP) can be used if limited to shorter, shallower runs. When possible, reduce the RPMs of the router for operations requiring the use of these bits.

Drawings are 1:1 scale



8/955.901

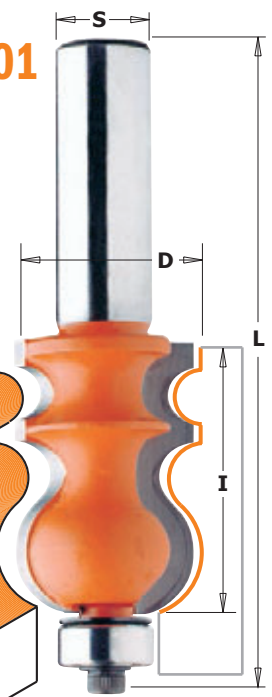

8/955.902

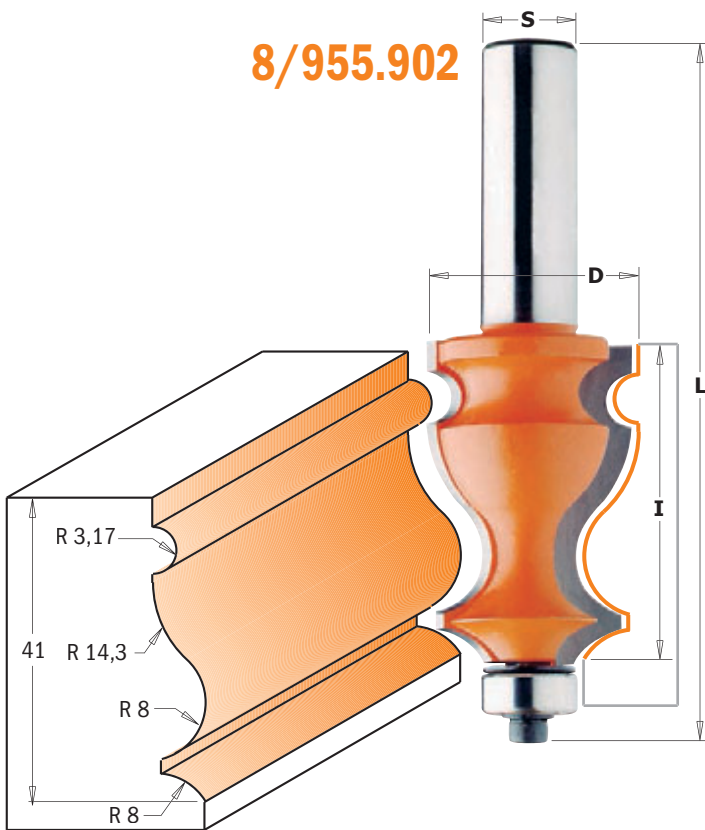

8/956.501

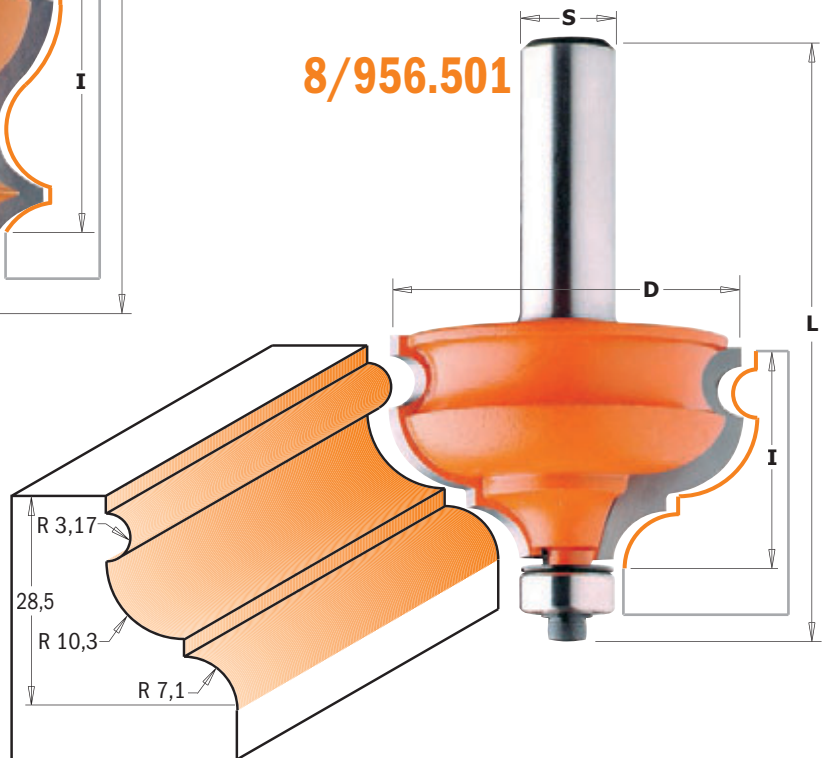

D mm	I mm	L mm	ORDER NO. S=Ø12mm	ORDER NO. S=Ø12,7mm	Spare parts			
23,8	35	83,8	955.901.11	855.901.11				
27	41	90,2	955.902.11	855.902.11	990.423.00	791.003.00	990.058.00	991.057.00
47,5	28,5	77,4	956.501.11	856.501.11	990.423.00	791.003.00	990.058.00	991.057.00



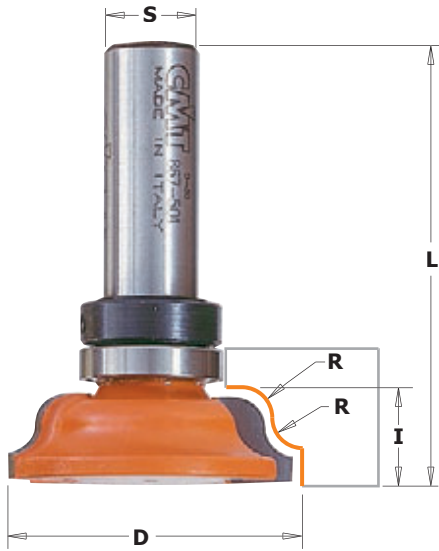

Molding bits

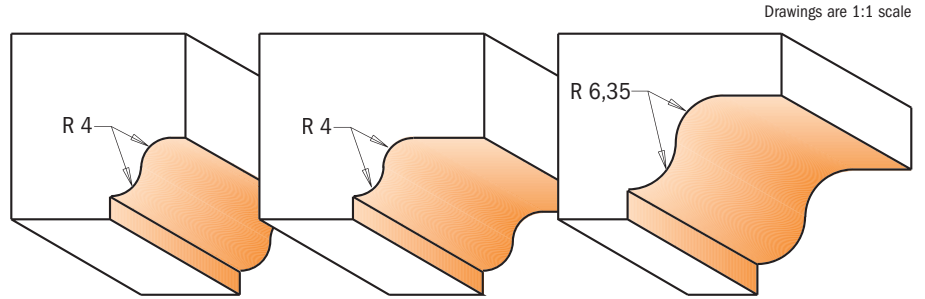

8/967.5B

CMT's new molding bits allow you to shape elegant moldings with your table saw and router. Unlike any commercially available crown moldings, moldings made with these bits are easy to install and create a finished appearance. After shaping the cove, you can use special router bits with inverted profiles to create different edges and complete the molding.



R mm	D mm	I mm	L mm	ORDER NO.	ORDER NO.	ORDER NO.	Spare parts			
				S=Ø8mm	S=Ø12mm	S=Ø12,7mm				
4	39,05	11,5	57	967.001.11B	967.501.11B	867.501.11B	791.011.00	541.002.00	990.005.00	991.056.00
4	54	11,5	65,9		967.502.11B	867.502.11B	791.011.00	541.002.00	990.005.00	991.056.00
6,35	60,5	17,3	71,7		967.503.11B	867.503.11B	791.011.00	541.002.00	990.005.00	991.056.00



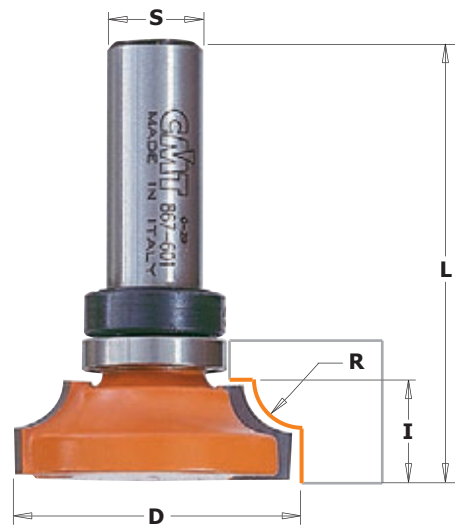

Molding bits

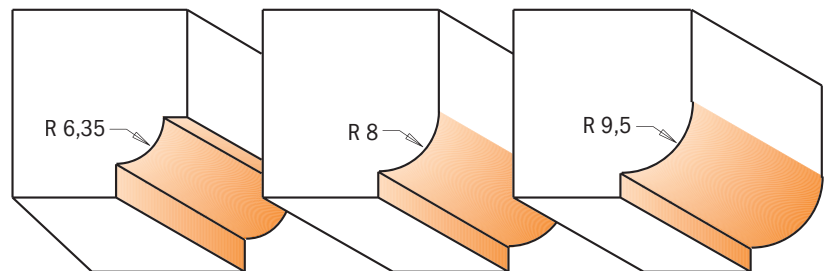

8/967.6B

CMT's molding bits allow you to shape elegant moldings with your table saw and router. Unlike any commercially available crown moldings, moldings made with these bits are easy to install and create a finished appearance. After shaping the cove, you can use special router bits with inverted profiles to create different edges and complete the molding.



R mm	D mm	I mm	L mm	ORDER NO.	ORDER NO.	ORDER NO.	Spare parts			
				S=Ø8mm	S=Ø12mm	S=Ø12,7mm				
6,35	38	12,5	57	967.101.11B	967.601.11B	867.601.11B	791.011.00	541.002.00	990.005.00	991.056.00
8	35	13,2	57,7	967.102.11B	967.602.11B	867.602.11B	791.011.00	541.002.00	990.005.00	991.056.00
9,5	38	14,5	59	967.103.11B	967.603.11B	867.603.11B	791.011.00	541.002.00	990.005.00	991.056.00

Saw blades

Jig saw blades

Tools with bore & Knives

Router bits & sets

CNC router cutter & chucks

Industrial dowel drills

Bits for hand power tools

Power tools & accessories

Display cabinets & spare parts

Finger pull bit

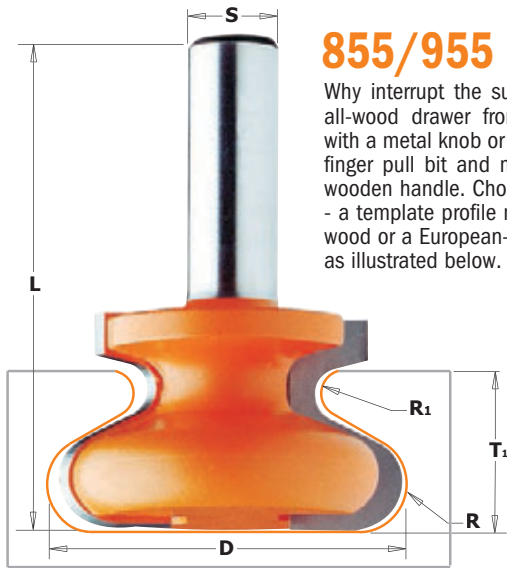

855/955

Why interrupt the subtle linearity of an all-wood drawer front or cabinet door with a metal knob or handle? Use a CMT finger pull bit and make a harmonious wooden handle. Choose your preference - a template profile made directly in the wood or a European-style hardwood pull as illustrated below.

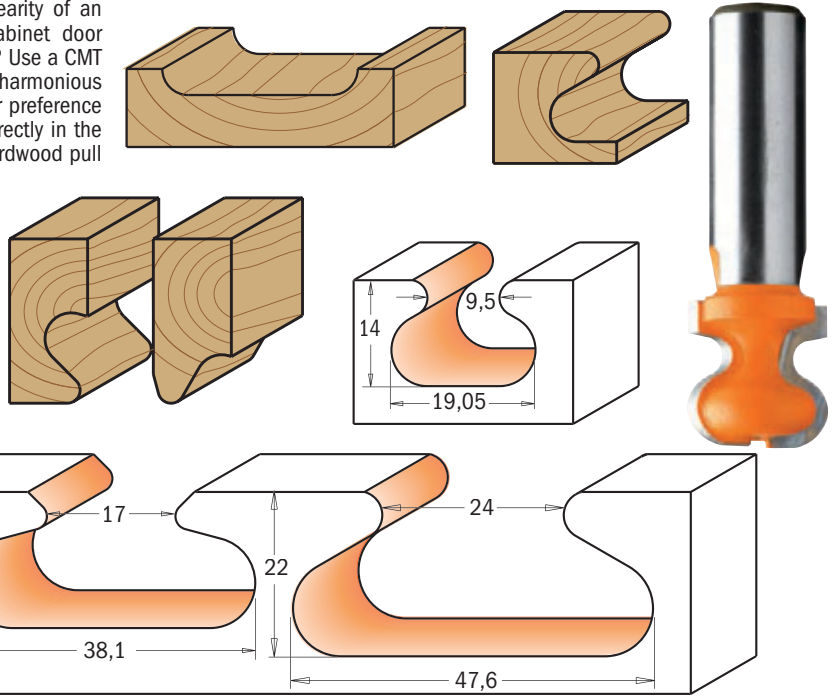

Drawings are 1:1 scale

D mm	d mm	T ₁ mm	l mm	R mm	R ₁ mm	L mm	ORDER NO. S=∅8mm	ORDER NO. S=∅12mm	ORDER NO. S=∅12,7mm
19,05	9,5	14	19,05	4,76	2,4	57,2	955.102.11		855.602.11
38,1	17	18	20,7	6	1,8	55,5	955.103.11		
38,1	17	18	20,7	6	1,8	61,8			855.603.11
47,6	24	22	28,5	6,35	3,2	66,6		955.601.11	855.601.11

Window sill and finger bits

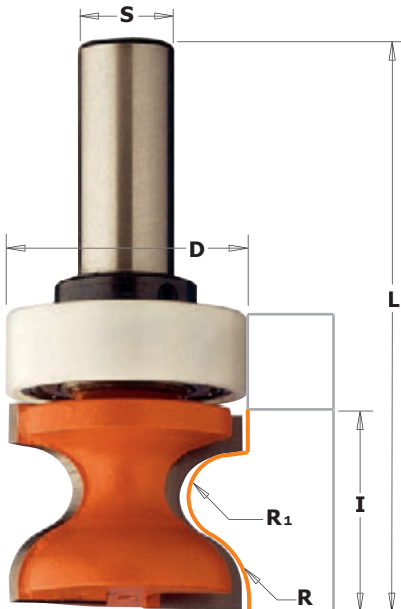

8/955.804/805 - 8/955.804B/805B

These profiles were originally intended for shaping the edges of window sills. Now these bits are also used for creating finger pulls on the edges of doors and drawers. These bits are available with top bearings for curved template work or without bearings for straight cuts against a fence. Recommended for router table use only.

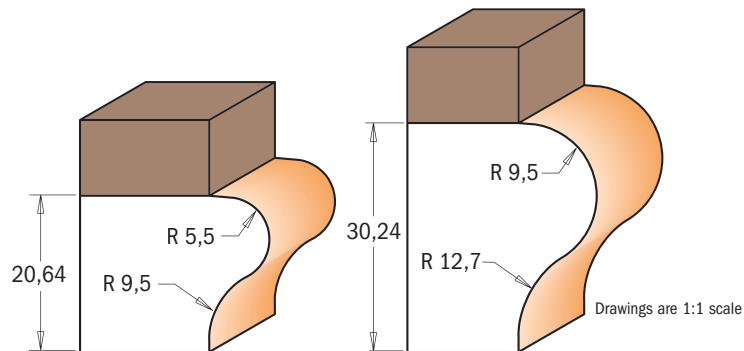

Drawings are 1:1 scale

R ₁ mm	R mm	D mm	l mm	L mm	ORDER NO. S=∅12mm	ORDER NO. S=∅12,7mm
5,5	9,5	31,7	25,4	73	955.804.11	855.804.11
9,5	12,7	38,1	35	85,8	955.805.11	855.805.11

with top bearing

5,5	9,5	31,7	25,4	73	955.804.11B	
5,5	9,5	31,7	25,4	73		855.804.11B
9,5	12,7	38,1	35	85,8	955.805.11B	
9,5	12,7	38,1	35	85,8		855.805.11B

Spare parts



791.015.00	541.005.00	990.005.00	991.056.00
791.015.00	541.002.00	990.005.00	991.056.00
791.020.00	541.005.00	990.005.00	991.056.00
791.020.00	541.002.00	990.005.00	991.056.00

Table edge and hand rail bits

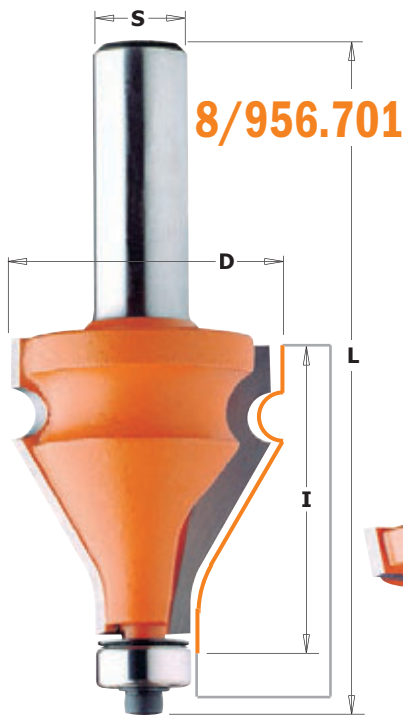

8/956.701

Turn a small investment into a big return with these CMT bits! They give you well-proportioned smooth curves for elegant eye-catching work on your tables. CMT hand rail bits feature 30° bevel edge and 3,2mm bead that allow you to make beautiful and functional hand rails. Add a touch of class to your architectural settings!

SAFETY TIPS: these profile bits remove large amounts of stock and make consistent quantities of dust. We recommend using a vacuum to keep the work area safe.

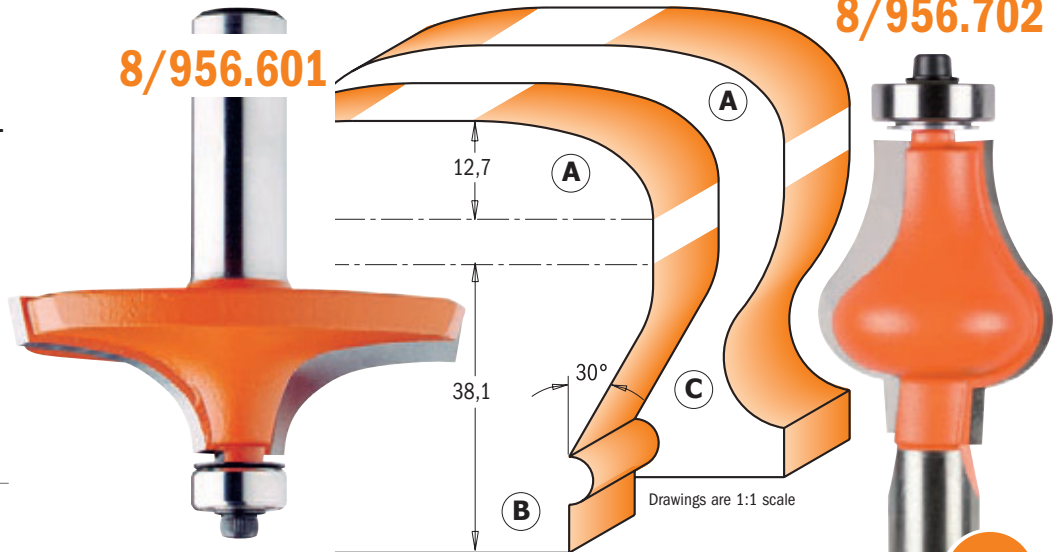

8/956.601

8/956.702

Profile	D mm	I mm	L mm	ORDER NO.	ORDER NO.	Spare parts			
				S=Ø12mm	S=Ø12,7mm	Flange	Washer	Pin	Hex key
A	63,5	19	67,9	956.601.11	856.601.11	990.423.00	791.003.00	990.058.00	991.057.00
B	35	38	87	956.701.11	856.701.11	990.423.00	791.003.00	990.058.00	991.057.00
C	31,7	38,1	87	956.702.11	856.702.11	990.423.00	791.018.00	990.058.00	991.057.00

Vertical raised panel bits

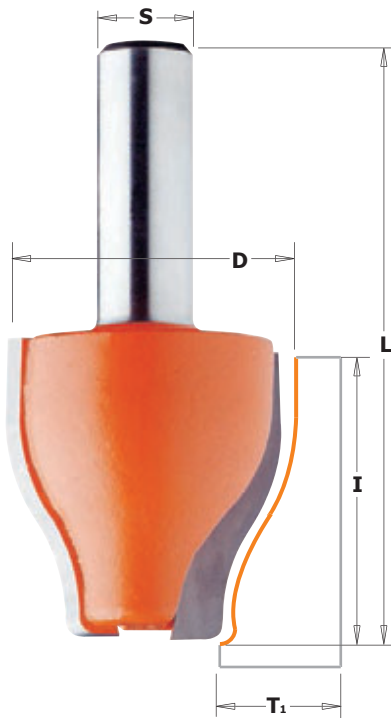

8/990.6

Mill raised panel doors and drawer fronts easily and economically just by putting a CMT vertical raised panel bit in your router* and a sturdy 90° fence on your router table. Meticulously studied, designed and crafted using the highest technology available, these bits are perfected down to the smallest detail. And just like any true craftsman, we are as proud of our work as you are of yours. Choose any of the three vertical profile designs for the style you want.

* Recommended for use on routers with a minimum speed of 1,7 KW (2-1/4 HP). Routers as low-powered as 1,1 KW (1-1/2 HP) can be used but we suggest limiting their use to shorter, shallower runs.

SAFETY TIPS: the template must be at least 150mm and clamps should be used whenever possible. Three to five passes are recommended to safely and accurately obtain the profile you desire.

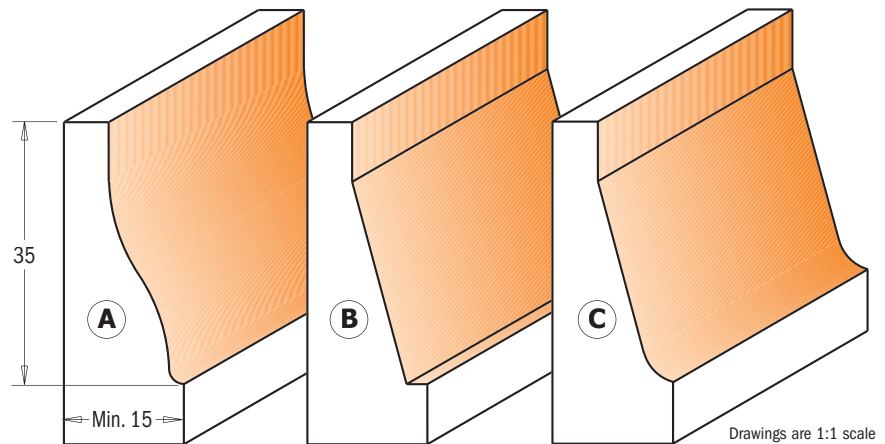

Profile	D mm	I mm	T ₁ mm	L mm	ORDER NO.	ORDER NO.
					S=Ø12mm	S=Ø12,7mm
A	38	38	15 ÷ 18	76,2	990.601.11	890.601.11
B	38	38	15 ÷ 18	76,2	990.602.11	890.602.11
C	38	38	15 ÷ 18	76,2	990.603.11	890.603.11

Saw blades
Jig saw blades
Tools with bore & Knives
Router bits & sets
CNC router cutter & chucks
Industrial dowel drills
Bits for hand power tools
Power tools & accessories
Display cabinets & spare parts

Raised panel bit with back cutter

8/990



These bits has a back-cutter which allows milling of both the front and back of the panel in the same cut. An additional 31,7mm diameter bearing promotes safety by allowing you to take two shallow passes (only for Ø89mm).

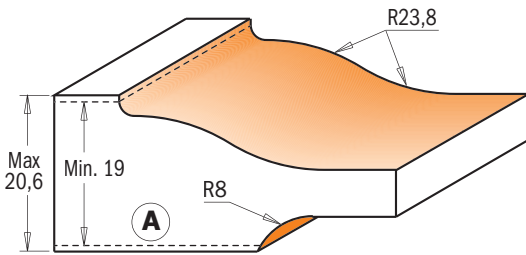
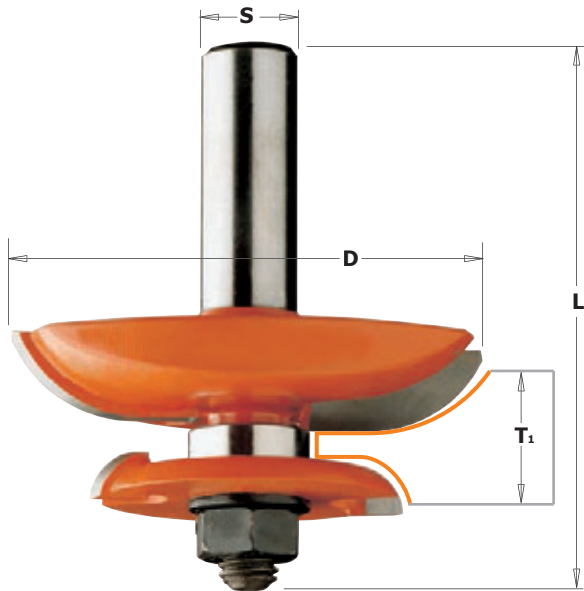

Drawings are 1:1 scale

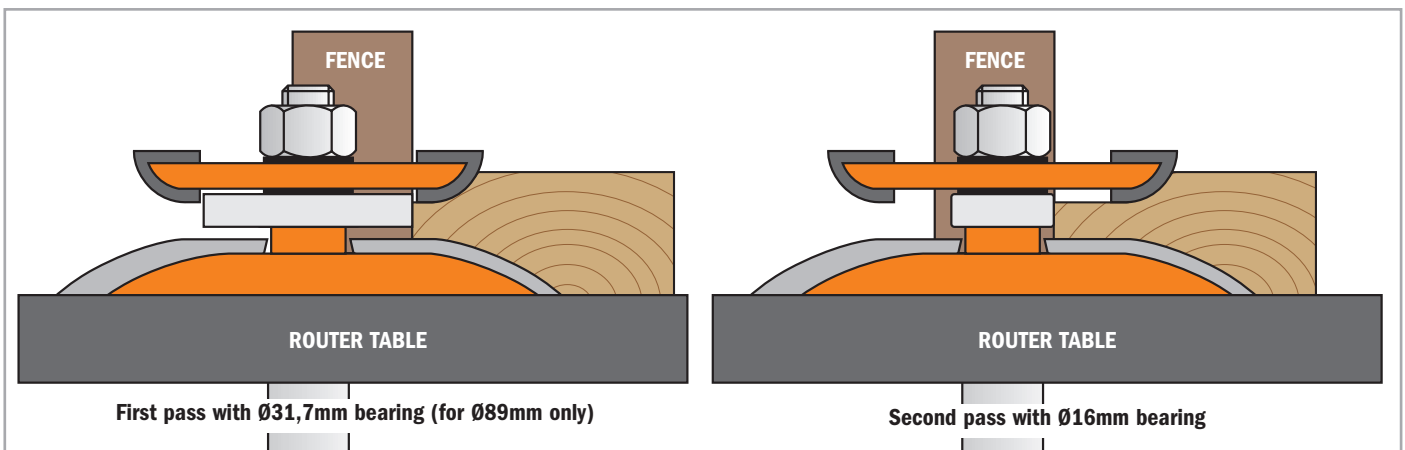
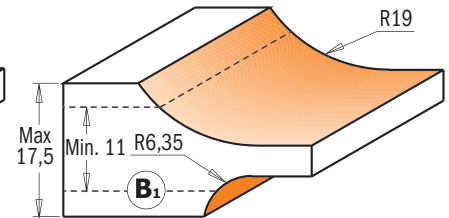
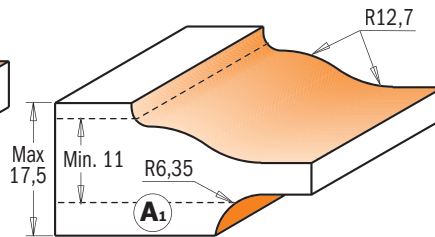
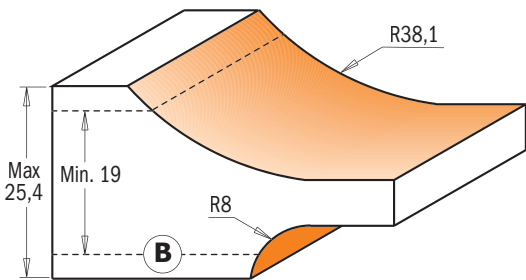

First pass with Ø31,7mm bearing (for Ø89mm only)

Second pass with Ø16mm bearing

Profile	D mm	T ₁ mm	L mm	ORDER NO. S=Ø12mm	ORDER NO. S=Ø12,7mm
A	89	19 - 20,6	78,1	990.524.11	890.524.11
B	89	19 - 25,4	78,1	990.527.11	890.527.11
A ₁	63,5	11,1 - 17,5	70	990.534.11	890.534.11
B ₁	63,5	11,1 - 17,5	70	990.537.11	890.537.11

Spare parts
 541.515.00 0,1mm spacer
 541.516.00 0,3mm spacer

541.518.00 1,0mm spacer
 990.407.00 Shield conical

Spare parts

822.007.11	791.025.00	791.033.00	990.020.00
822.007.11	791.025.00	791.033.00	990.020.00
822.010.11	791.025.00		990.020.00
822.010.11	791.025.00		990.020.00

Raised panel bits

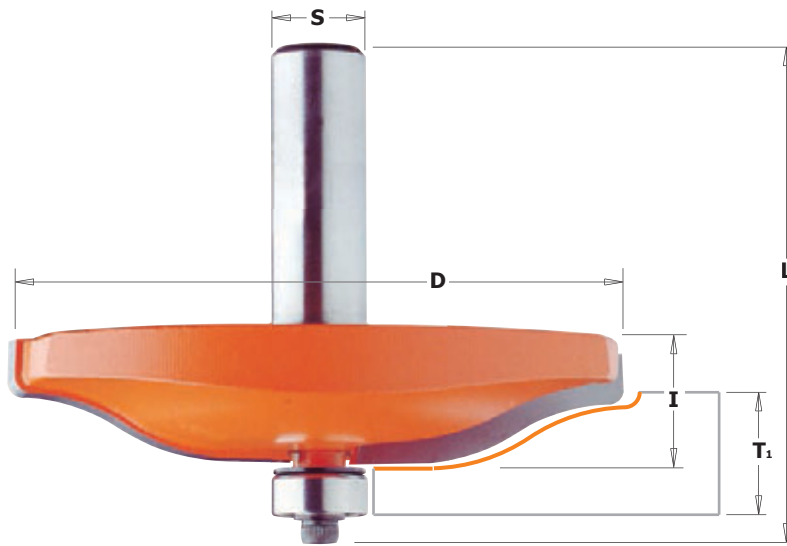

8/990.5



We offer you the traditional approach to panel construction with the CMT raised panel bit. Make classic raised panel doors as shown in the profiles below.

These raised panel bits have carbide-faced cutting edges and are equipped with our anti-kickback design and orange non-stick coating to further increase your safety when working with larger diameter bits.

SAFETY TIPS: Horizontally employed bits should be used at a lower speed, between 10,000 and 12,000 RPMs.

Three to five passes are recommended to safely and accurately obtain the profile you desire.

To be used on jigs with at least 1,7 KW (2-1/4 HP).

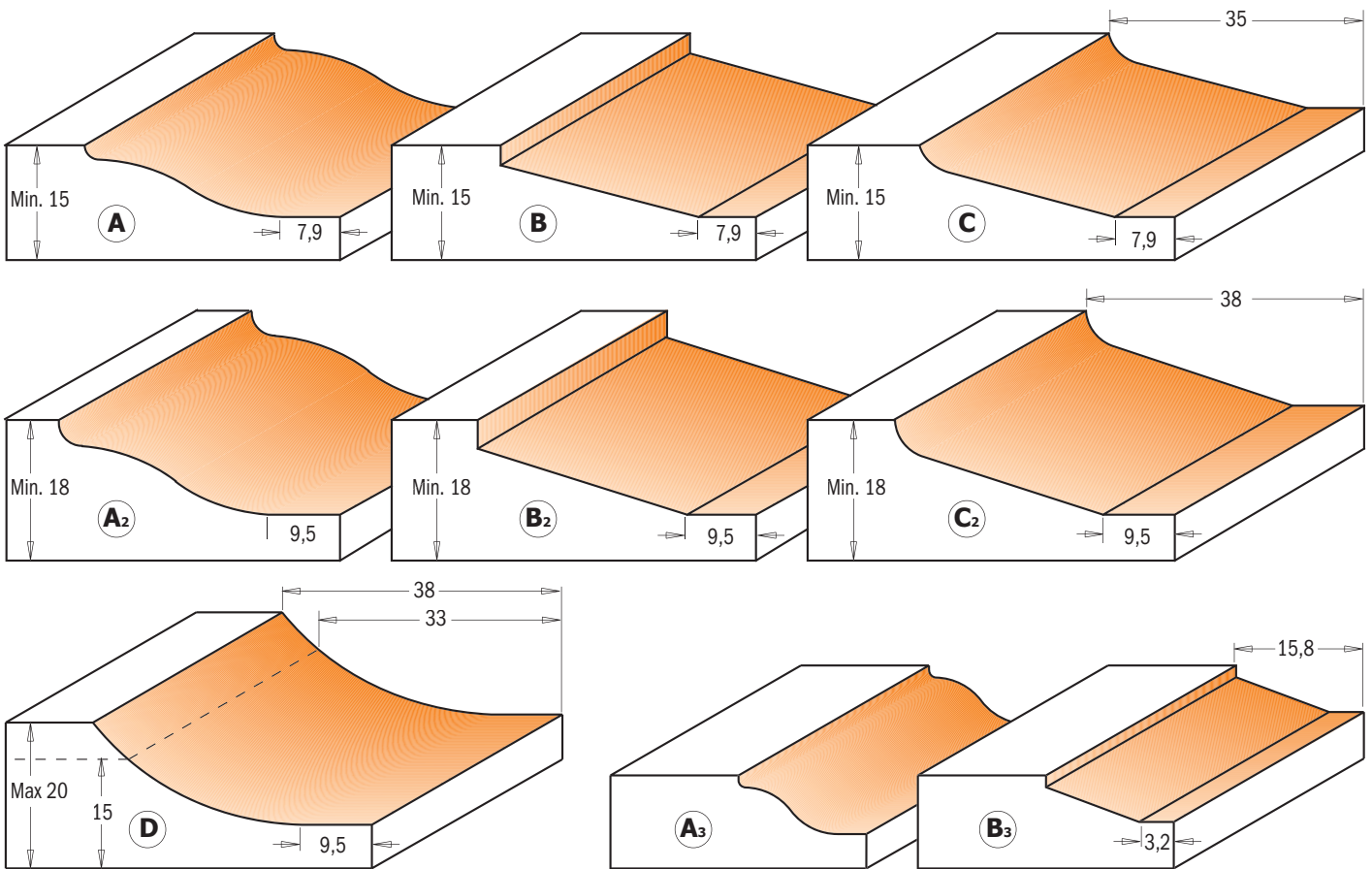

Drawings are 1:1 scale

Profile	D mm	I mm	L mm	T ₁ mm	ORDER NO.	ORDER NO.	ORDER NO.	Spare parts			
					S=Ø8mm	S=Ø12mm	S=Ø12,7mm				
A	82,5	15	63,8	15 ÷ 18		990.501.11	890.501.11	990.423.00	791.003.00	990.058.00	991.057.00
B	82,5	15	63,8	15 ÷ 18		990.502.11	890.502.11	990.423.00	791.003.00	990.058.00	991.057.00
C	82,5	15	64,6	15 ÷ 18		990.503.11	890.503.11	990.423.00	791.003.00	990.058.00	991.057.00
A ₂	89	15	64,6	18 ÷ 20		990.504.11	890.504.11	990.423.00	791.003.00	990.058.00	991.057.00
B ₂	89	15	64,6	18 ÷ 20		990.505.11	890.505.11	990.423.00	791.003.00	990.058.00	991.057.00
C ₂	89	15	64,6	18 ÷ 20		990.506.11	890.506.11	990.423.00	791.003.00	990.058.00	991.057.00
D	89	15	64,6	15 ÷ 20		990.507.11	890.507.11	990.423.00	791.003.00	990.058.00	991.057.00
A ₃	47,6	9,5	58,1	12,7 ÷ 15	990.011.11			990.423.00	791.003.00	990.058.00	991.057.00
B ₃	47,6	9,5	58,1	12,7 ÷ 15	990.012.11		890.512.11	990.423.00	791.003.00	990.058.00	991.057.00

Saw blades
Jig saw blades
Tools with bore & Knives
Router bits & sets
CNC router cutter & chucks
Industrial dowel drills
Bits for hand power tools
Power tools & accessories
Display cabinets & spare parts

Junior ogee rail and stile set

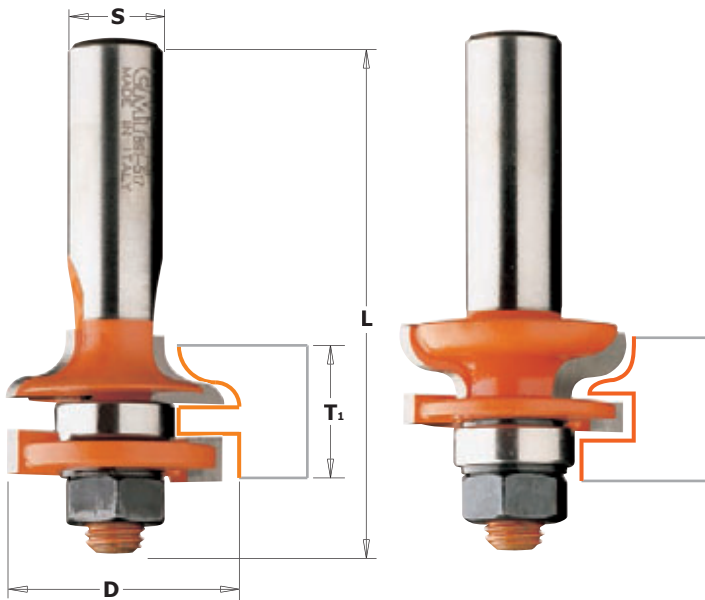





8/991.517

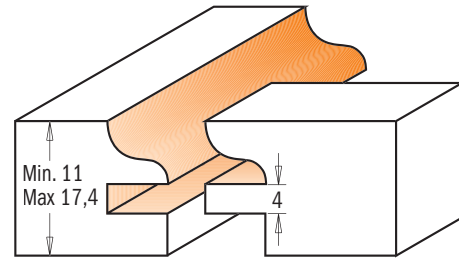

These bits are designed for those special projects that require a smaller panel door. Use these bits with stock from 11,1mm to 17,4mm thick, and build doors as small as 70mm.



D mm	T ₁ mm	L mm	ORDER NO. S=Ø12mm	ORDER NO. S=Ø12,7mm	Spare parts			
31,75	11 ÷ 17,4	67	991.517.11	891.517.11	 4mm	 6mm		

Spare parts

541.515.00	0,1mm spacer
541.516.00	0,3mm spacer
541.518.00	1,0mm spacer

Rail and stile set

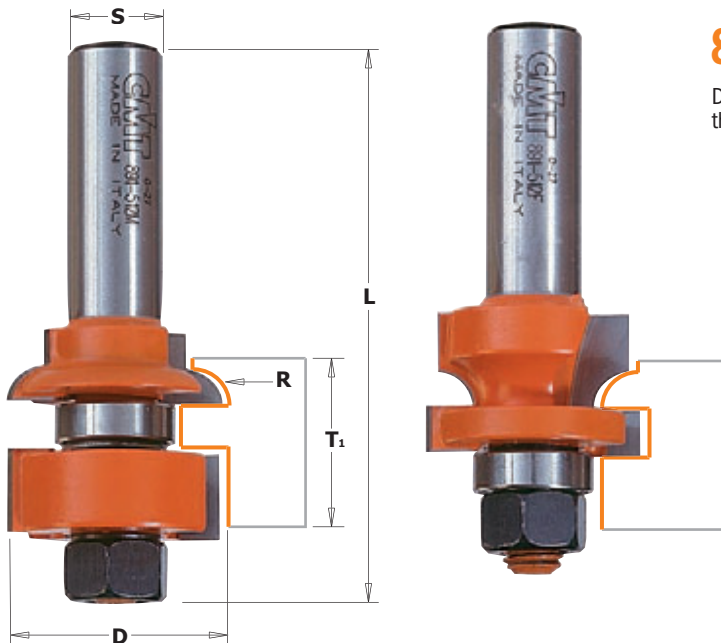





8/991.512

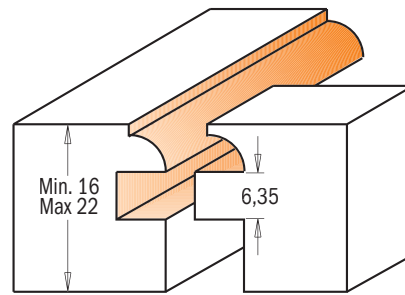

Designed for fine furniture construction, these bits mill a delicate 4,75mm thumbnail profile in stock from 15,8mm to 20,6mm.



D mm	T ₁ mm	R mm	L mm	ORDER NO. S=Ø8mm	ORDER NO. S=Ø12,7mm	Spare parts			
28,7	16 ÷ 22	4,8	79,2	991.012.11	891.512.11	 6,35mm	 10,8mm		

Spare parts

541.515.00	0,1mm spacer
541.516.00	0,3mm spacer
541.518.00	1,0mm spacer

Rail & stile sets

Saw blades
Jig saw blades
Tools with bore & Knives
Router bits & sets
CNC router cutter & chucks
Industrial dowel drills
Bits for hand power tools
Power tools & accessories
Display cabinets & spare parts

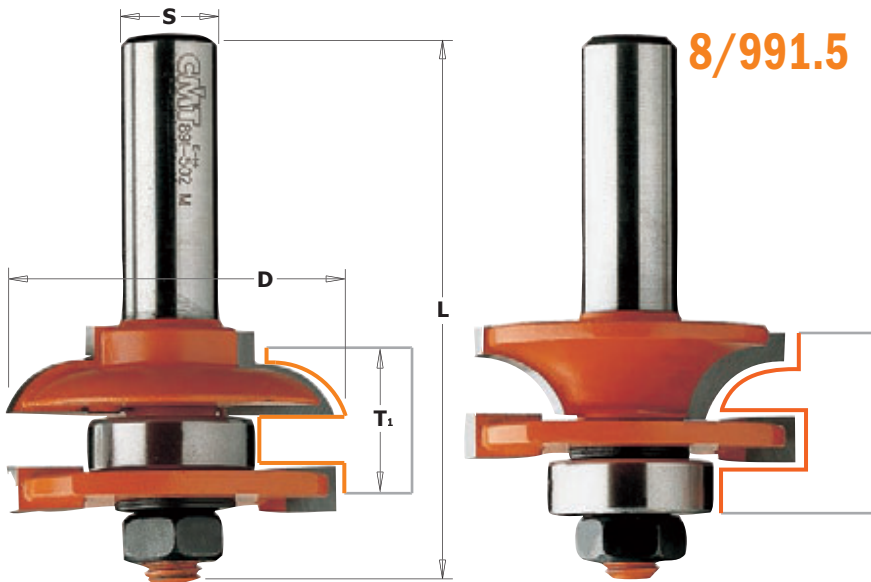

8/991.5

A well-constructed door will bear the mark of a perfect joint-clean, exact and well-crafted for strength. For this project, the CMT male-female rail and stile sets are the perfect pair. Made to our specifications they match exactly; not simply approximated like standard reversible cutters.

Choose the style of CMT rail and stile set that best suits your needs and create smooth, perfect joints in hard and soft woods with accuracy and speed. Perfect for working in stock from 18mm to 22mm. See chart and illustrations below for profile options available.

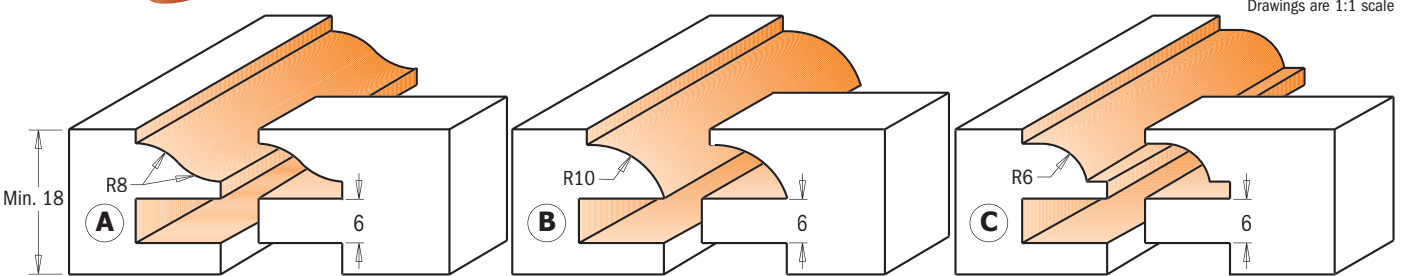

Drawings are 1:1 scale

Profile	D mm	L mm	T ₁ mm	ORDER NO.	ORDER NO.	ORDER NO.	Spare parts					
				S=Ø8mm	S=Ø12mm	S=Ø12,7mm						
A	44,4	71	18 ÷ 22	991.001.11	991.501.11	891.501.11	822.003.11	791.012.00	541.515.00	514.516.00	990.407.00	990.020.00
B	44,4	71	18 ÷ 22		991.502.11	891.502.11	822.003.11	791.012.00	541.515.00	541.516.00	990.407.00	990.020.00
C	44,4	71	18 ÷ 22		991.503.11	891.503.11	822.003.11	791.012.00	541.515.00	541.516.00	990.407.00	990.020.00

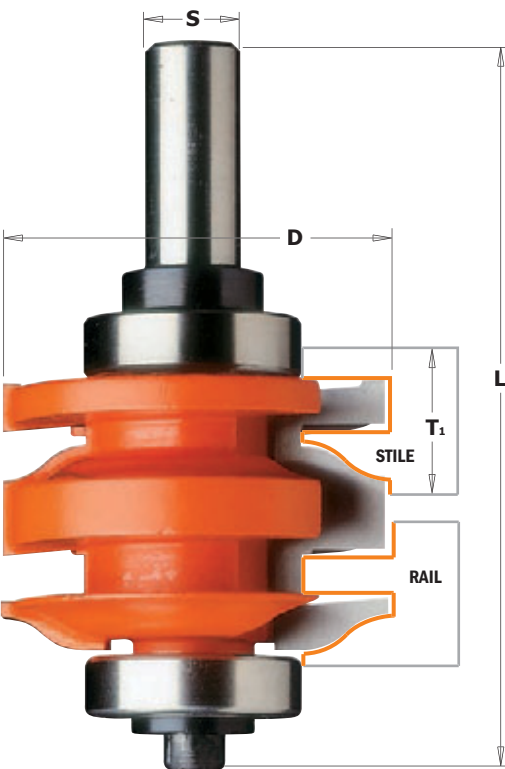

8/991.521



The most innovative bit for the construction of furniture doors and drawers. The new CMT One-Piece Rail and Stile Bit represents the union of two cutters in one bit. By simply adjusting the height of the bit, you can cut two perfectly joining profiles with no wasted time or effort moving the fence or changing the bit. Save money by investing in a single CMT bit and a more efficient production. For working in stock from 18mm to 22,2mm.

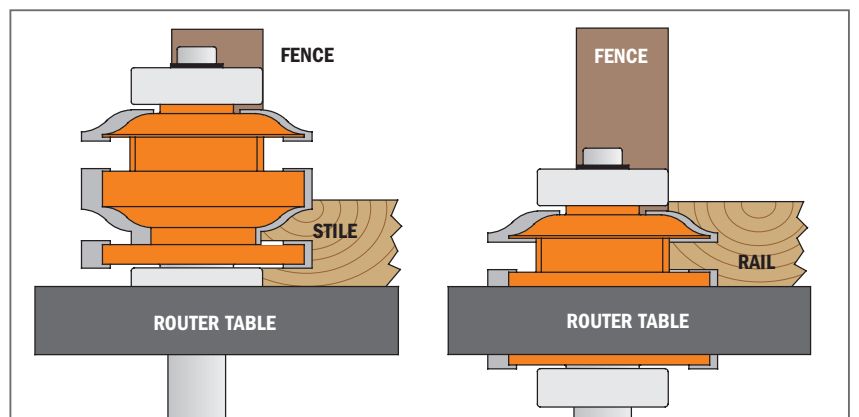

Profile	D mm	L mm	T ₁ mm	ORDER NO.	ORDER NO.	Spare parts						
				S=Ø12mm	S=Ø12,7mm							
A	50,87	87,5	18 ÷ 22		891.521.11	791.027.00	541.002.00	990.005.00	991.056.00	541.551.00	990.010.00	991.064.00
A	50,87	87,5	18 ÷ 22	991.521.11		791.027.00	541.005.00	990.005.00	991.056.00	541.551.00	990.010.00	991.064.00

In our step-by-step example of panel door construction, we used the following:

- CMT Rail & Stile set (item #891.502.11)
- CMT Reverse Glue Joint (item #855.501.11)
- pre-cut to length stiles - 19mm thick x 57mm wide
- pre-cut to length rails - 19mm thick x 57mm wide
- panel - 16mm thick
- scrap stock

The CMT Rail & Stile set was designed ideally for the construction of panel doors from 19mm thick stock, however any variation of size up to 22mm thick can be used. Remember to adjust your measurements and cutting depths according to the wood thickness you use.

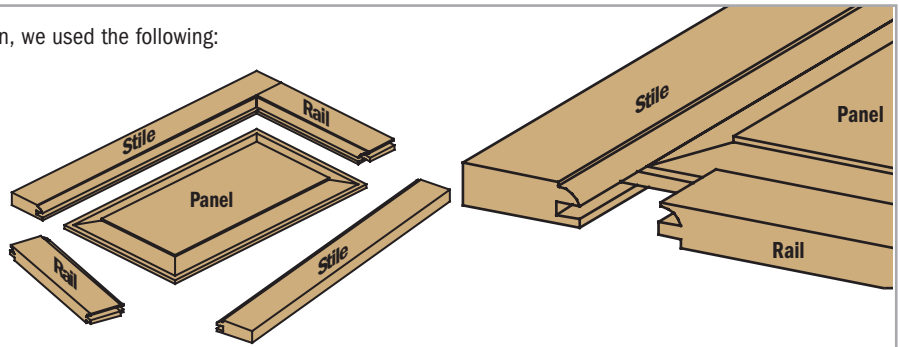

ILLUSTRATION A

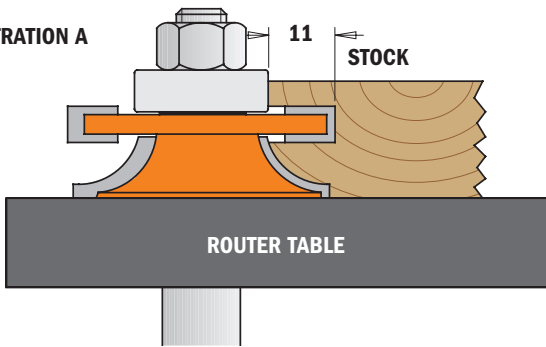
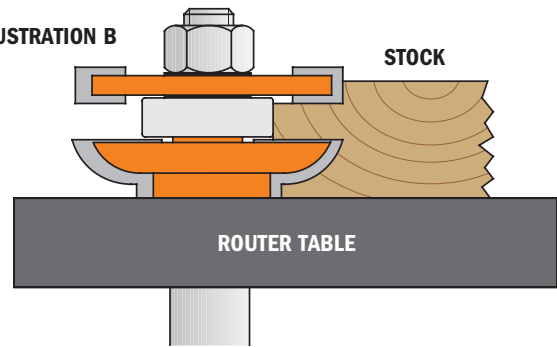

ILLUSTRATION B



MILLING THE RAILS AND STILES

First make trial cuts of the cope profile (rail) and the stick profile (stile) in scrap stock and check the accuracy of the joint. This is extremely important when working at maximum thickness (22mm). Make sure your stock is flat and cut straight with square edges. Using the CMT Stile Bit shown in illustration A, place the stock front face-down on the router table and mill the stick profile in the stile and rail pieces. To mill the rails, use the CMT Rail Bit shown in illustration A, position the rails face-down on the router table and mill the cope profile in the ends. If you are milling cope and stick profiles before cutting the rails and stiles to length, be sure to make the proper calculations before cutting the rails. The stiles are the same length as the door. The rails must be calculated by the following equation (CMT standard tenon length is 22mm):

(total door width - sum of stile widths) + sum of 2 tenons = total rail length
 therefore, using our example measurements listed above, for a 300mm cabinet door:
 $300 - 114 + 22 = 208\text{mm}$

GLUEING UP PANELS

If the panel requires a width greater than the width of your stock, you will need to edge glue stock for the central floating panel. This is simply accomplished using the CMT Reverse Glue Joint bit. For making a two panel glue joint, place the first panel front face down on the router table and accurately centre the wood to the bit: Adjust the bit according to the thickness of the wood you are cutting by lining up the cut edge of the wood to the centre point of the bit as illustrated in illustration B and mill the cut edge of the wood. Place the second panel front face up and repeat the milling process. This assures you will have the best side of your stock as a front face. If a third panel is required, mill one cut edge of the piece as instructed above, turn the piece over and run the other edge. Assemble the reverse cut pairs together for beautiful, strong joints that match up perfectly.

MILLING THE FLOATING PANEL

Make trial cuts in scrap stock to create a tongue that fits snugly into the groove in the stile without forcing it. To cut your panel to size be sure to make the proper calculations, taking into account the length of the tongue. The CMT Raised Panel Bit in our example has a standard tongue length of 8mm (The New CMT Raised Panel Bit profile has a 9,5mm tongue).

Use the following equation:
 (Total door length - Sum of Stile widths) + Sum of 2 Tongues = Overall Panel Length

Therefore, using our example measurements listed above for a 600mm long cabinet door: $(600 - 114) + 16\text{mm} = 502\text{mm}$

And accordingly:

(Total door width - Sum of Stile widths) + Sum of 2 Tongues = Overall Panel Width.

Once the panel has been cut to proper dimensions, position the panel front face side down on the router table tongue as shown in illustration C and use the CMT Raised Panel Bit to mill the tongue. ATTENTION: this bit is capable of removing large amounts of stock. To safely and effectively produce the profile you want, we suggest making several shallow passes. It can be dangerous to try to mill the entire profile in a single run.

ILLUSTRATION C

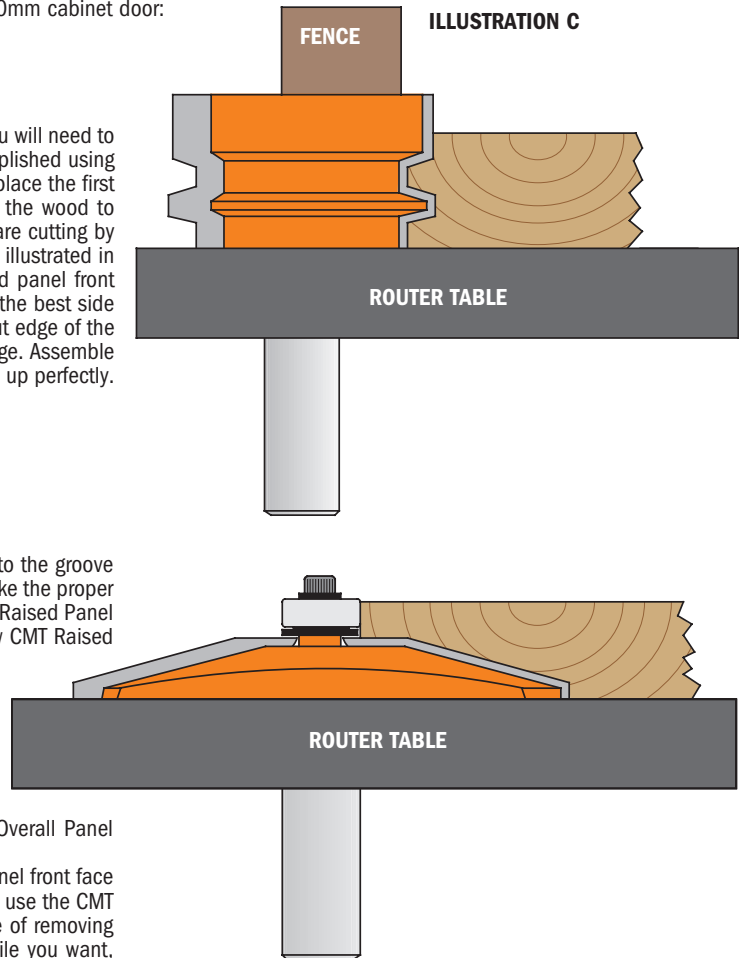

Stile & panel router bits

8/970



These bits can be used for decorative work on solid wood panels and MDF materials. Use them in one pass or in combination with CMT's MDF panel bits for complex and intricate profiles. A simple approach for an elegant appearance.

Featuring large cutting diameters and available in the most popular profiles, these panel bits guarantee excellent performance on both solid wood panels and MDF materials.

PANEL BITS



870.501.11
970.501.11



870.502.11
970.502.11



870.503.11
970.503.11

STILE BITS

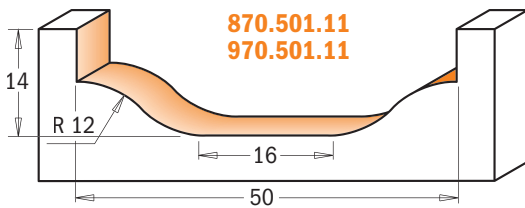

870.501.11
970.501.11

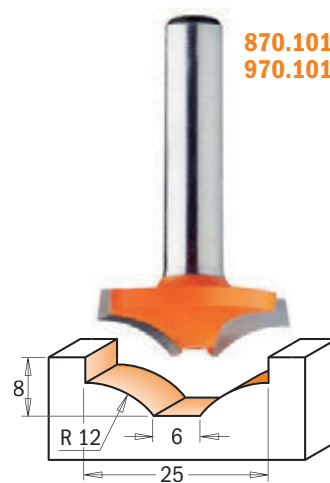

870.101.11
970.101.11

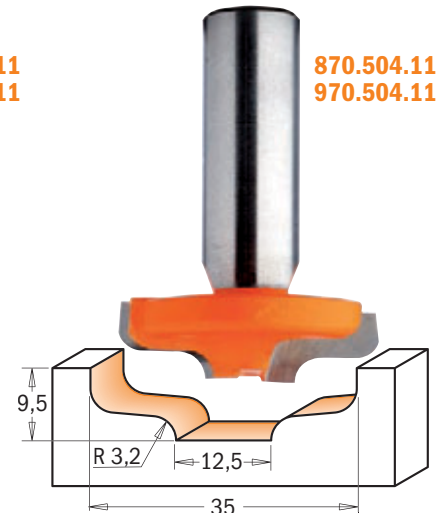

870.504.11
970.504.11

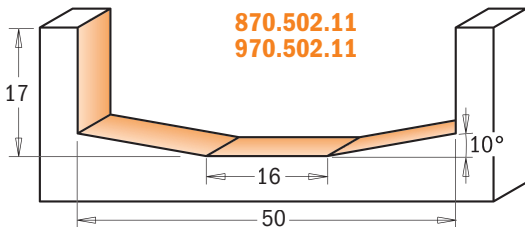

870.502.11
970.502.11

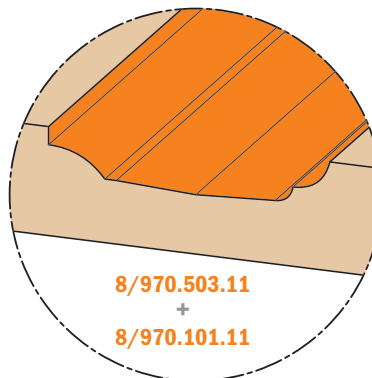

8/970.503.11
+
8/970.101.11

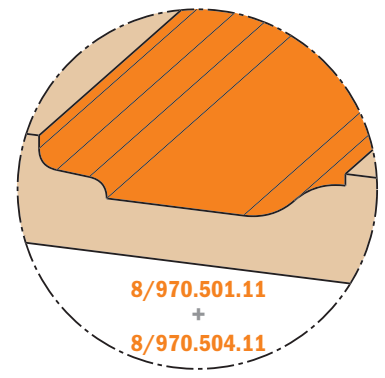

8/970.501.11
+
8/970.504.11

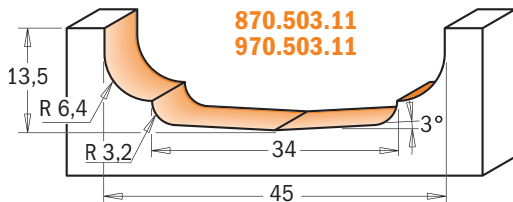

870.503.11
970.503.11

D mm	d mm	I mm	R mm	A	L mm	ORDER NO. S=Ø6,35mm	ORDER NO. S=Ø8mm	ORDER NO. S=Ø12mm	ORDER NO. S=Ø12,7mm
25	6	8	12		39,8	870.101.11	970.101.11		
50	16	14	12		52,1			970.501.11	870.501.11
50	16	17		10°	55,1			970.502.11	870.502.11
45	34	13,5	3,2 - 6,4	3°	51,6			970.503.11	870.503.11
35	12,5	9,5	3,2		47,6			970.504.11	870.504.11

Saw blades
Jig saw blades
Tools with bore & Knives
Router bits & sets
CNC router cutter & chucks
Industrial dowel drills
Bits for hand power tools
Power tools & accessories
Display cabinets & spare parts

Solid surface rounding over bits

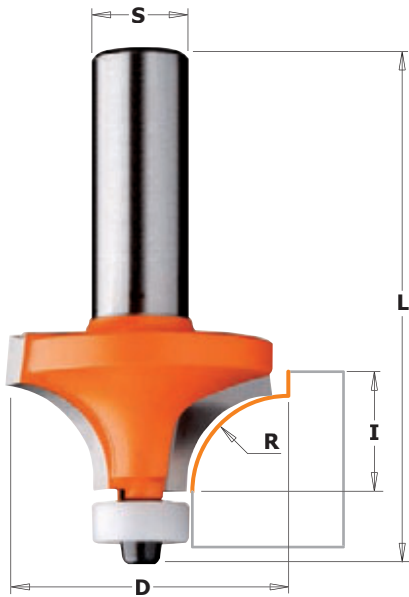

8/980.501-502-503-504



Use these bits to create a traditional roundover edge on solid surface countertops. Equipped with a non-marring Delrin® bearing to protect the finished edges. For use on hand-held portable routers.

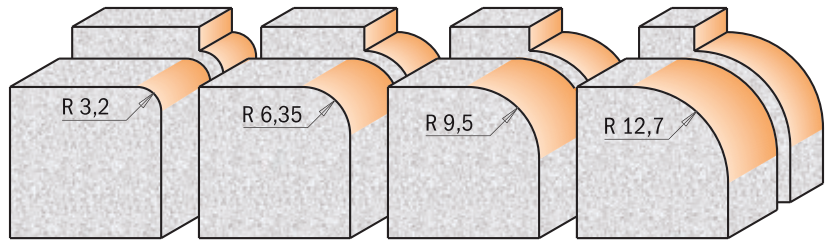

Drawings are 1:1 scale

D mm	I mm	R mm	L mm	ORDER NO. S=∅12mm	ORDER NO. S=∅12,7mm	Spare parts		
19,05	12,7	3,2	59,4	980.501.11	880.501.11			
25,4	12,7	6,35	59,4	980.502.11	880.502.11	791.044.00	990.058.00	991.057.00
31,75	14	9,5	60,7	980.503.11	880.503.11	791.044.00	990.058.00	991.057.00
38,1	19,05	12,7	65,8	980.504.11	880.504.11	791.044.00	990.058.00	991.057.00

Solid surface decorative edge profile bits

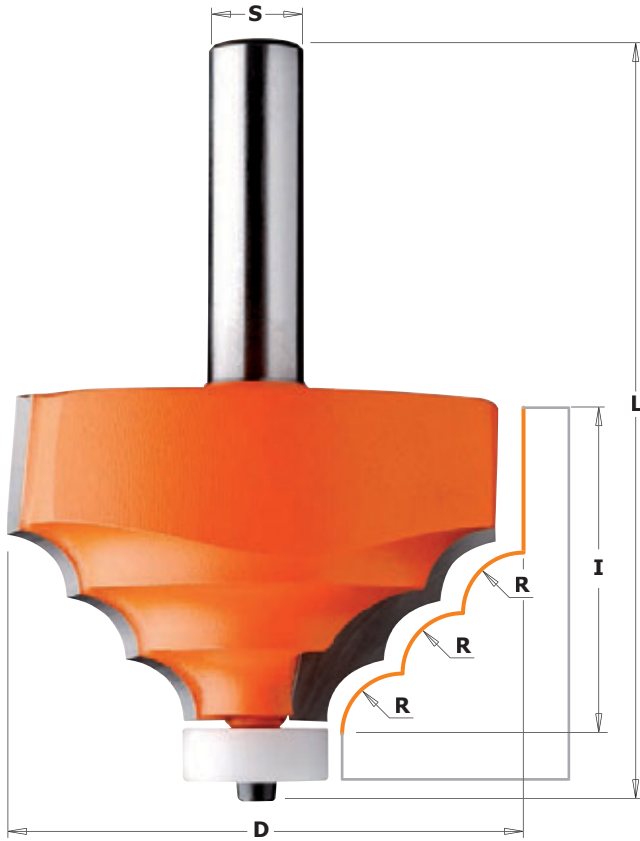

8/980.521



Create elegant countertops with flawless results. Features a non-marring Delrin® bearing to protect the finished edges. For use on hand-held portable routers.

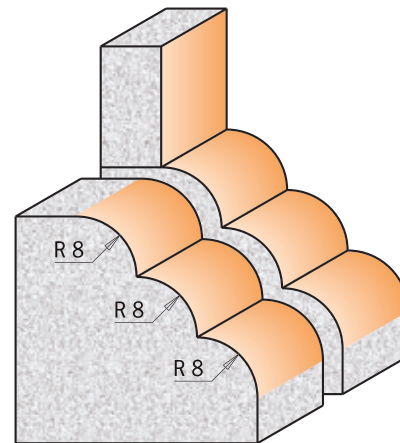

Drawings are 1:1 scale

D mm	I mm	R mm	L mm	ORDER NO. S=∅12mm	ORDER NO. S=∅12,7mm	Spare parts		
66,7	41,3	8	89,8	980.521.11	880.521.11			
						791.046.00	990.058.00	991.057.00

Solid surface rounding over bowl bits

Saw blades

Jig saw blades

Tools with bore & Knives

Router bits & sets

CNC router cutter & chucks

Industrial dowel drills

Bits for hand power tools

Power tools & accessories

Display cabinets & spare parts



8/966.601/602
8/980.541

These bits roundover and trim the countertop edges after the bowl is mounted. Can be used with the CMT 880.551.11 bevel cutter for a flush cut-out between the countertop and installed undermount bowl. For use on hand-held portable routers. Features a non-marring Delrin® bearing to protect the finished edges.

Special angled Delrin® sleeve on the bearing of the CMT bevel cutter lets you work without leaving marks on the workpiece. Trims and shapes all wood and wood materials. Perfect for kitchen and bathroom counter top work.

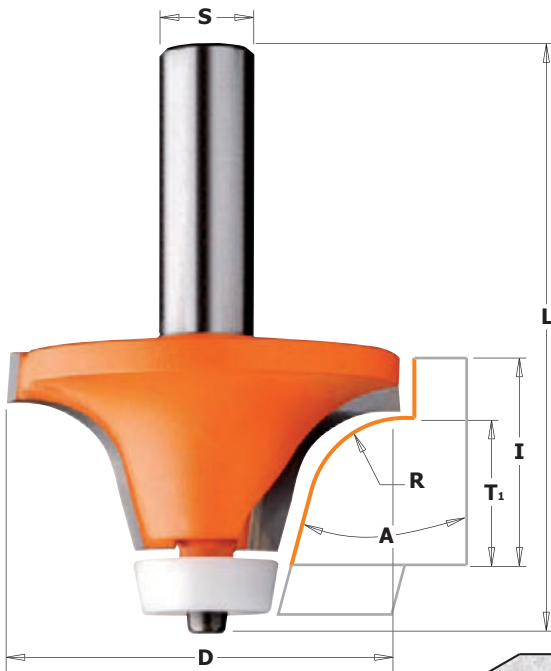

880.541.11
980.541.11

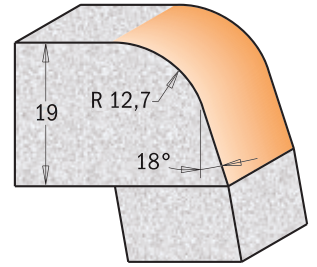

Drawings are 1:1 scale

966.601.11
866.601.11

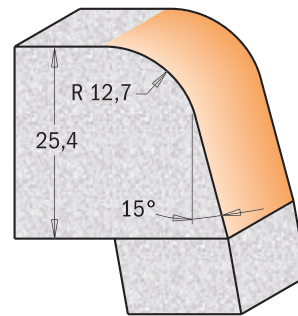
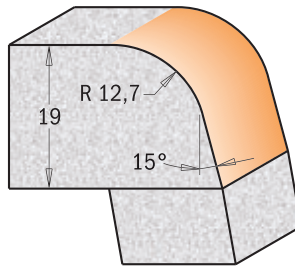

966.602.11
866.602.11

A	D mm	T ₁ mm	I mm	R mm	L mm	ORDER NO. S=Ø12mm	ORDER NO. S=Ø12,7mm
15°	50,8	19	25,4	12,7	74,9	966.601.11	866.601.11
15°	50,8	25,4	31,75	12,7	81,3	966.602.11	866.602.11
18°	54	19	25,4	12,7	78,1	980.541.11	880.541.11

Spare parts

791.041.00	990.058.00	991.057.00
791.041.00	990.058.00	991.057.00
791.041.00	990.058.00	991.057.00

Solid surface rounding over bowl bit (ogee profile)



8/980.542

These bits roundover and trim the countertop edges after the bowl is mounted. Can be used with the CMT 880.551.11 bevel cutter for a flush cut-out between the countertop and installed undermount bowl. For use on hand-held portable routers. Features a non-marring Delrin® bearing to protect the finished edges.

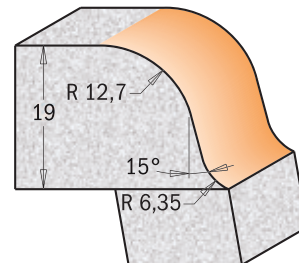
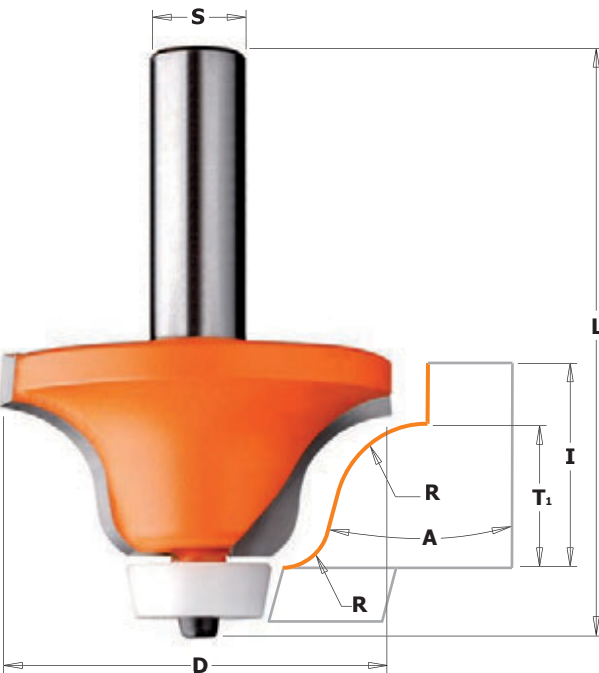

Drawing is 1:1 scale

A	D mm	T ₁ mm	I mm	R mm	L mm	ORDER NO. S=Ø12mm	ORDER NO. S=Ø12,7mm
15°	54	19	25,4	6,35-12,7	77,6	980.542.11	880.542.11

Spare parts

791.041.00	990.058.00	991.057.00

Solid surface bevel bowl bits



8/966.501 - 8/980.551



These bits are designed for undermount applications joining the countertops and sink bowls with a 10 (degree) beveled edge. Can be used with the 880.541.11 and 880.542.11 for complete undermount applications. For use on hand-held routers. Features a non-marring Delrin® bearing to protect the finished edges.

Special angled Delrin® sleeve on the bearing of the CMT bevel cutter lets you work without leaving marks on the workpiece. Trims and shapes all wood and wood materials. Perfect for kitchen and bathroom counter top work.

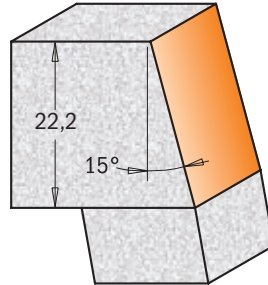
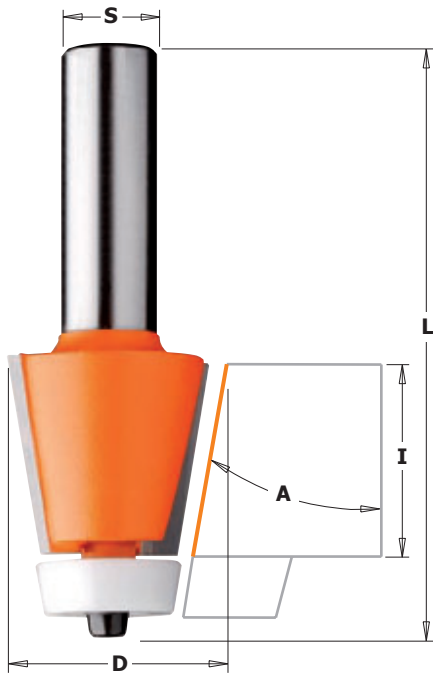

866.501.11
966.501.11

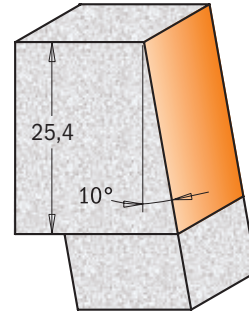

880.551.11
980.551.11

Drawings are 1:1 scale

A	D mm	I mm	L mm	ORDER NO. S=Ø12mm	ORDER NO. S=Ø12,7mm	Spare parts		
15°	31,7	22,2	72	966.501.11	866.501.11			
10°	28,5	25,4	77	980.551.11	880.551.11	791.041.00	990.058.00	991.057.00

Solid surface bevel bit

8/981.521



Edge profile bit designed to create a 15° bevel on solid surface countertops. Can also be used for European type topmount installation with sinks and bowls. For use on hand-held portable routers.

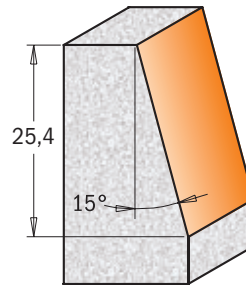
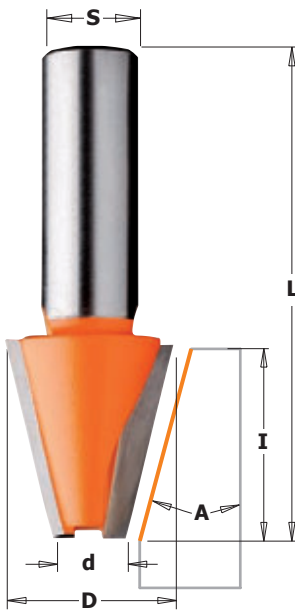

Drawings are 1:1 scale

D mm	d mm	I mm	A	L mm	ORDER NO. S=Ø12mm	ORDER NO. S=Ø12,7mm
23	9,52	25,4	15°	63,5	981.521.11	881.521.11

Saw blades
Jig saw blades
Tools with bore & Knives
Router bits & sets
CNC router cutter & chucks
Industrial dowel drills
Bits for hand power tools
Power tools & accessories
Display cabinets & spare parts

Solid surface cut and plug repair set

new

CMT ORANGE TOOLS™

HW Z2 RH

9/881.541

Special carbide-tipped bits to be used on solid surface for repairing your ruined surfaces. To repair, create the plug with the plug cutter first, then use the other bit to easily make the hole. Your surfaces will look like new. To be used on hand-held routers or CNC machines.

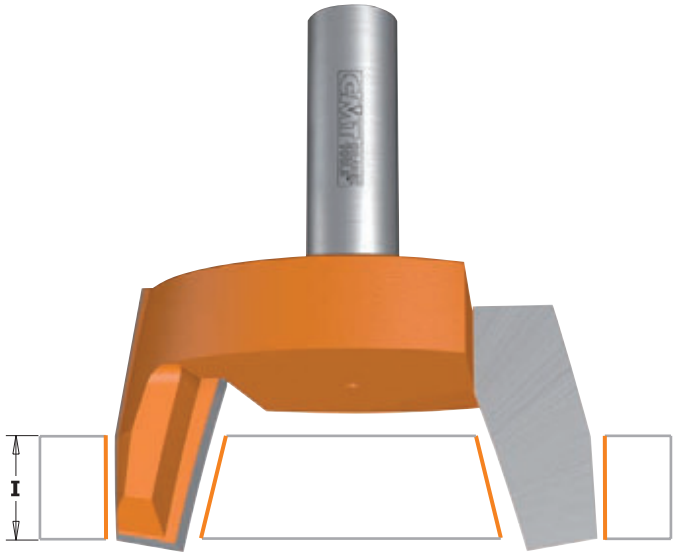
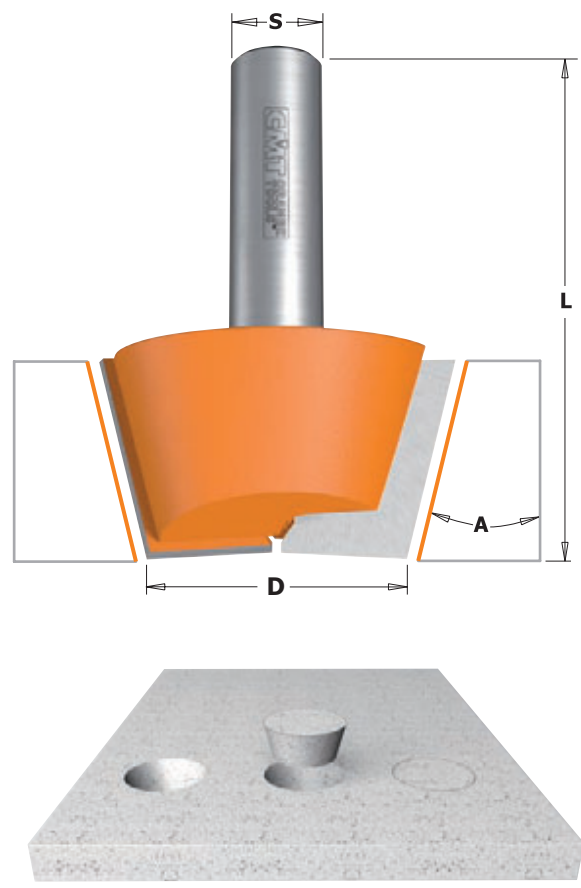

D mm	I mm	A	L mm	ORDER NO. S=Ø12mm	ORDER NO. S=Ø12,7mm
33,5	20	15°	68,5-74	981.541.11	881.541.11

4-wing cut out slot cutters for solid surface

new

8/922.033B

HW Z4 RH

Tools featuring specially formulated carbide-tipped cutting edges for cutting your solid surface undermount bowls. For use on hand-held portable routers. Bits feature a non-marring Delrin® bearing to protect your surfaces.

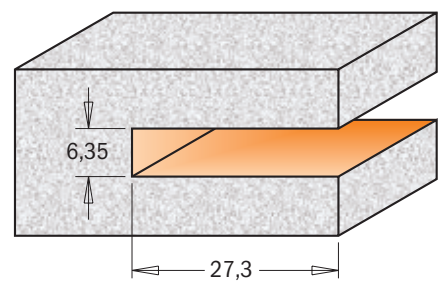
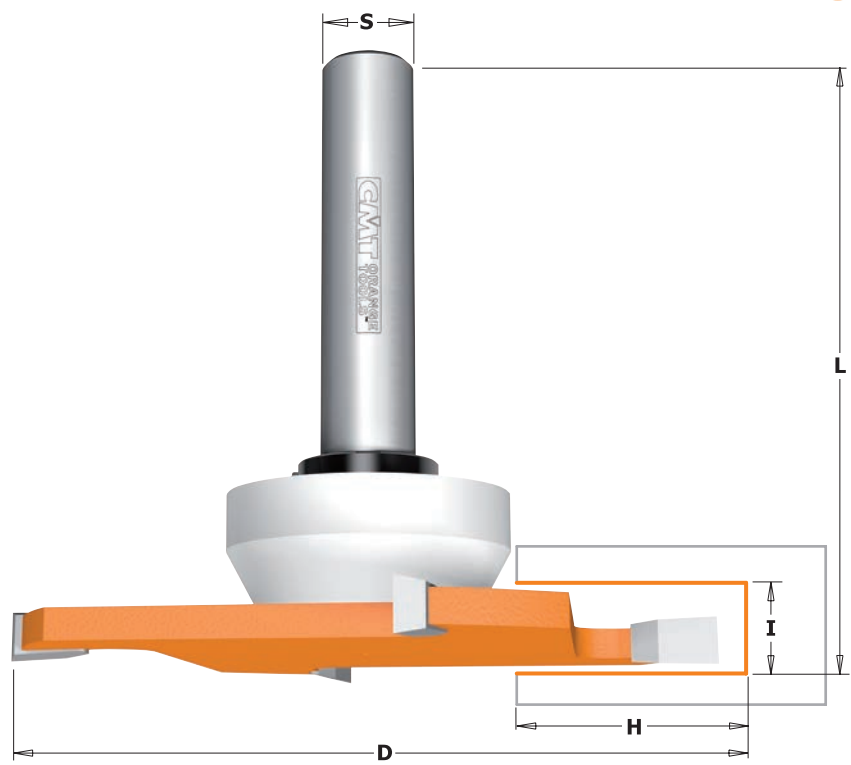

Drawing is 1:1 scale

D mm	I mm	H mm	L mm	ORDER NO. S=Ø12mm	ORDER NO. S=Ø12,7mm
92	6,35	27,3	82,5	922.033.11B	822.033.11B

Spare parts



541.553.00 791.047.00 541.002.00 991.056.00

Solid surface no-drip bit



8/981.501

This bit is designed to create "no-drip" edges on kitchen and vanity counter tops. Designed for hand-held portable routers on applications where a guide bearing can not be used. This one bit will cut both the outer and inner profiles creating a slightly raised edge, controlling spilled liquids.

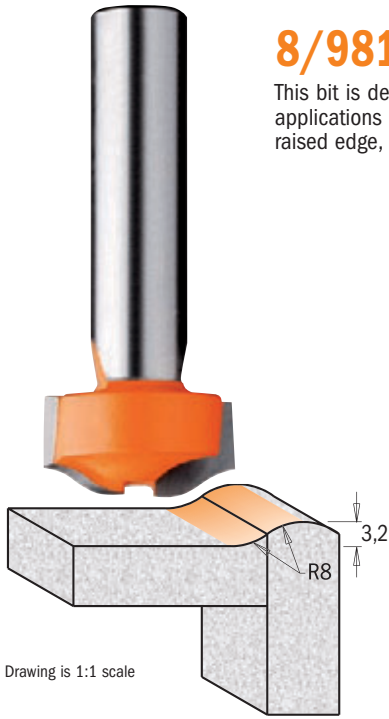

Drawing is 1:1 scale

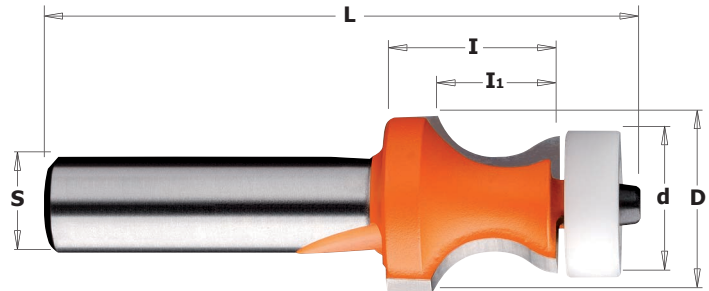

8/980.531

This bit is designed to create "no-drip" edges on kitchen and vanity counter tops in a single pass. For use on hand-held portable routers. This one bit will cut both the outer and inner profiles creating a slightly raised edge that controls spilled liquids. Features a non-marring Delrin® bearing to protect the finished edges.

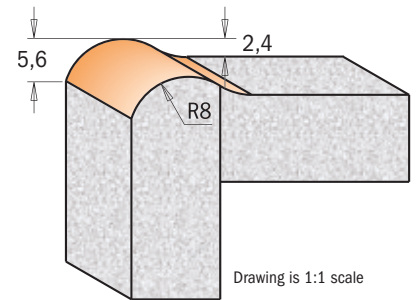

Drawing is 1:1 scale

D mm	d mm	I mm	I ₁ mm	R mm	L mm	ORDER NO. S=Ø12mm	ORDER NO. S=Ø12,7mm	Spare parts		
25,4		12,7	3,2	8	63,5	981.501.11	881.501.11			
25,4	19	22,2	15,87	8	77	980.531.11	880.531.11	791.046.00	990.058.00	991.057.00

Solid surface wavy joint bit

8/981.531

These bits are ideal for making strong joints on any solid surface, thanks to a wider area for glue.

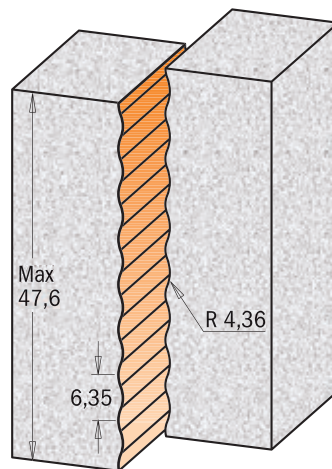
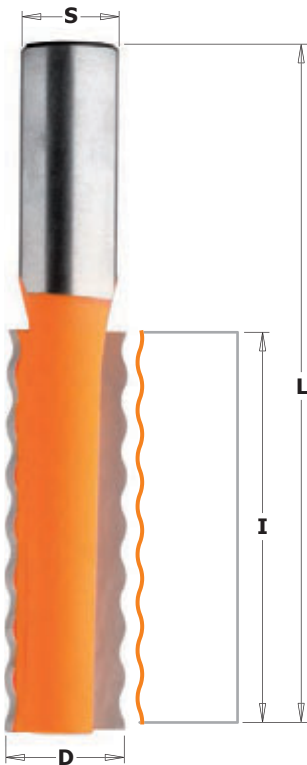

Drawings are 1:1 scale

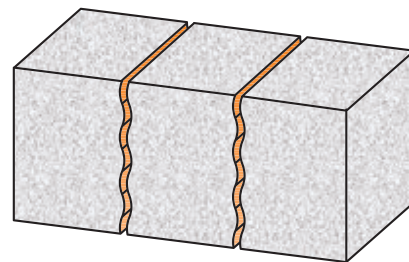

D mm	I mm	R mm	L mm	ORDER NO. S=Ø12mm	ORDER NO. S=Ø12,7mm
15,87	51,5	4,36	89	981.531.11	881.531.11

Solid surface drainboard bits

Saw blades

Jig saw blades

Tools with bore & Knives

Router bits & sets

CNC router cutter & chucks

Industrial dowel drills

Bits for hand power tools

Power tools & accessories

Display cabinets & spare parts

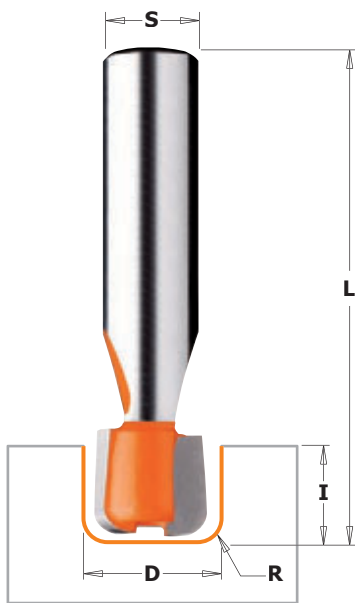

8/981.511-512

This bit is ideal for creating custom Drainboard patterns in solid surface countertops. For use on hand-held portable routers.

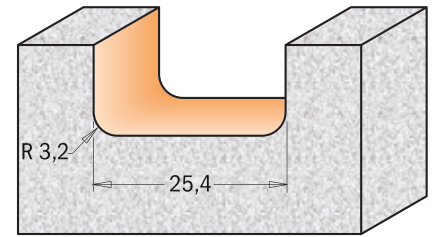
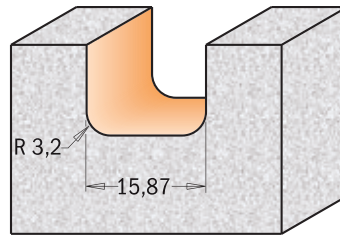

Drawings are 1:1 scale

D mm	I mm	R mm	L mm	ORDER NO. S=Ø12mm	ORDER NO. S=Ø12,7mm
15,87	12,7	3,2	63,5	981.511.11	881.511.11
25,4	12,7	3,2	69,8	981.512.11	881.512.11

Solid surface - inlay bits



8/980.511-512-513

Add a decorative wood, plastic or metal inlay to solid surface countertops. Equipped with a non-marring Delrin® bearing to protect the finished edges. For use on hand-held portable routers.

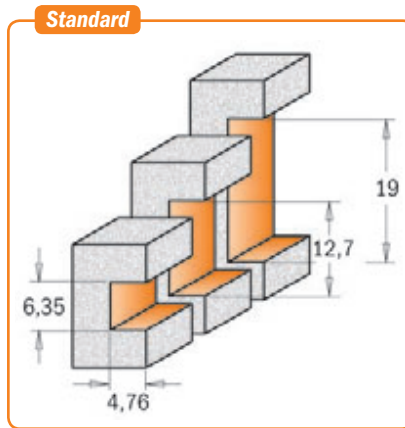

Drawings are 1:1 scale

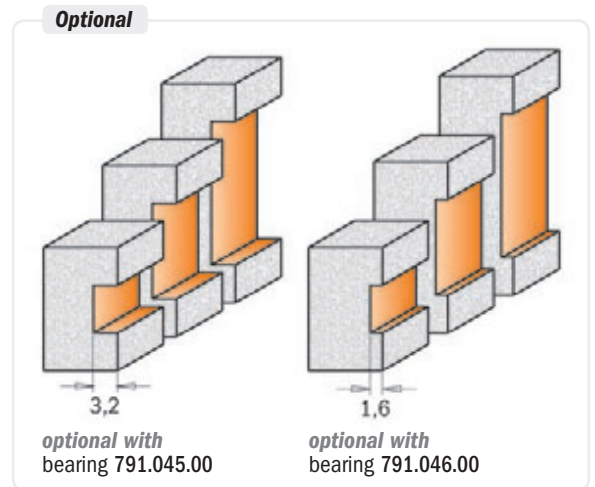

D mm	I mm	H mm	L mm	ORDER NO. S=Ø12mm	ORDER NO. S=Ø12,7mm	Spare parts		
22,2	6,35	4,76	77	980.511.11	880.511.11			
22,2	12,7	4,76	90	980.512.11	880.512.11	791.044.00	990.058.00	991.057.00
22,2	19,05	4,76	90	980.513.11	880.513.11	791.044.00	990.058.00	991.057.00

Router bit sets

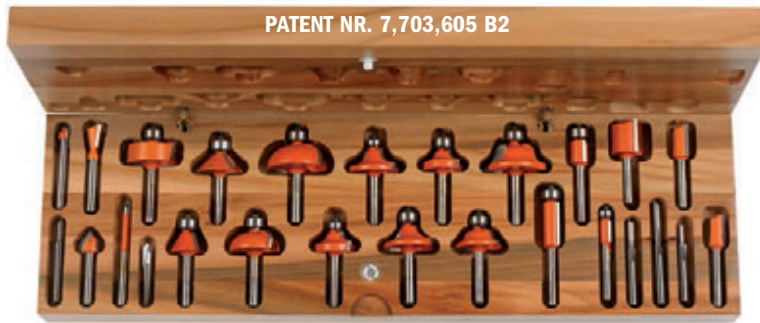

PATENT NR. 7,703,605 B2

7/900.003



Find a whole workshop in practical 26 piece router bit sets! With a wide selection of the most demanded tools, these sets include straight bits, flush trim bits, dovetail bits, cove bits, ogee bits and many more. You will have an endless choice to express your creativity! Ideal for master craftsmen, these sets are available from 6 to 8mm shank diametres. See chart below for details.

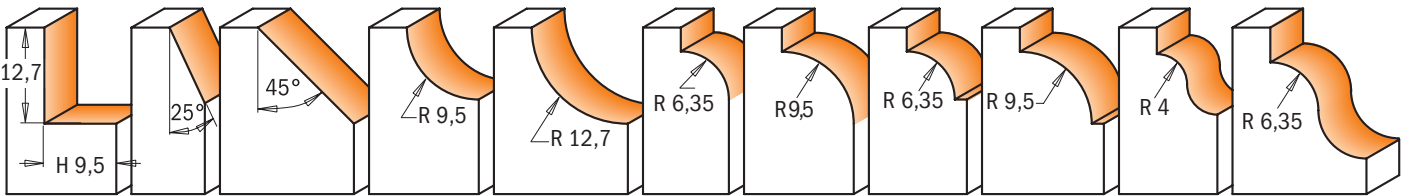
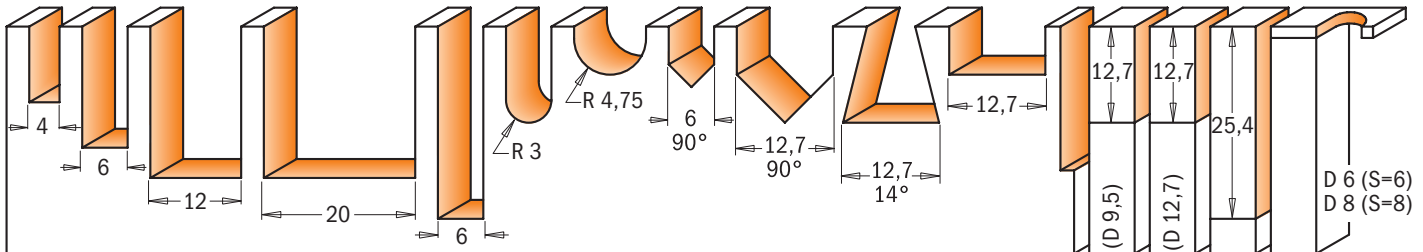

Drawings are 1:1 scale

DESCRIPTION	ORDER NO.	ORDER NO.
	S=Ø6mm	S=Ø8mm
26 piece router bit sets	700.003.00	900.003.00



PATENT NR. 7,703,605 B2

7/8/900.001



CMT's beautiful sets are the perfect companions for the professional craftsman. These sets offer a selection of organized and ready-to-use straight and profile bits; added value for any woodworker! Each bit is made of Fatigue Proof® steel, micrograin carbide and is coated with orange non-stick PTFE. The bits can be safely stored in their hardwood snap lock cases.

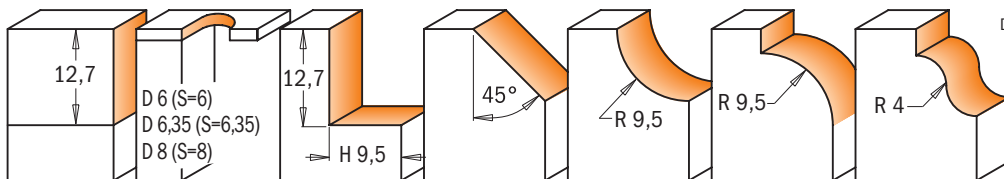
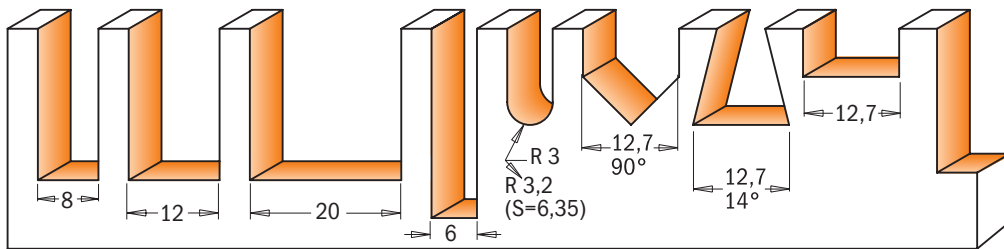

Drawings are 1:1 scale

DESCRIPTION	ORDER NO.	ORDER NO.	ORDER NO.
	S=Ø6mm	S=Ø6,35mm	S=Ø8mm
15 piece router bit sets	700.001.00	800.001.00	900.001.00

Saw blades
Jig saw blades
Tools with bore & Knives
Router bits & sets
CNC router cutter & chucks
Industrial dowel drills
Bits for hand power tools
Power tools & accessories
Display cabinets & spare parts

8 piece dovetail and straight bit sets



800.500/501

Perfect for the craftsman with a creative flair, these CMT's sets contain the most frequently used bits for boxes, creative joinery and a wide range of other projects. Safely packaged in a hardwood box to have the bits within a hand's reach. The bits suit most popular jigs.

IDEAL FOR INCRA & JOINTECH JIGS.

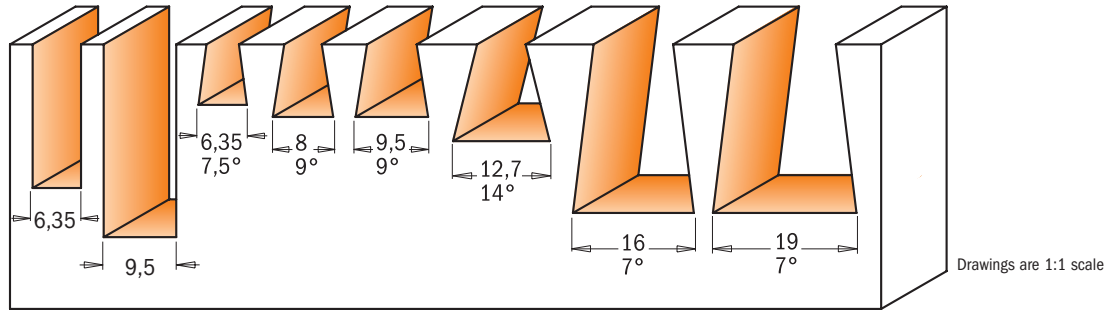

DESCRIPTION	ORDER NO. S=Ø6,35mm	ORDER NO. S=Ø12,7mm
8 piece dovetail and straight bit sets	800.500.11	800.501.11

13 piece dovetail and straight bit sets

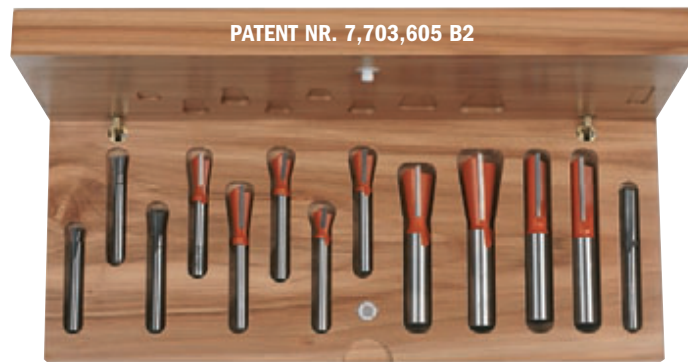

800.519

Perfect for the craftsman with a creative flair, these CMT's sets contain the most frequently used bits for making boxes, creative joinery and a wide range of other projects. Safely packaged in a hardwood box to have the bits within a hand's reach. The bits suit most popular jigs.

IDEAL FOR D4 LEIGH JIGS.

Drawings are 1:1 scale

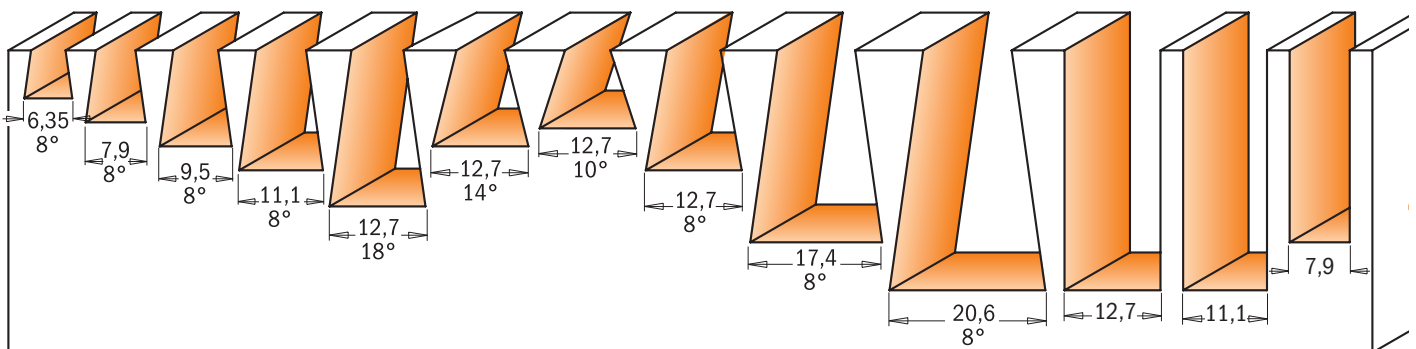

DESCRIPTION	ORDER NO. S=Ø6,35-12,7mm
13 piece dovetail and straight bit sets	800.519.11

Saw blades
Jig saw blades
Tools with bore & Knives
Router bits & sets
CNC router cutter & chucks
Industrial dowel drills
Bits for hand power tools
Power tools & accessories
Display cabinets & spare parts

12 piece router bit set with wooden case



800.503



Containing 12 of CMT's most frequently used 6,35mm shank router bits featuring the finest steel and carbide, plus CMT's baked-on orange PTFE non-stick coating, this compact Italian hardwood case is beautiful and convenient for your woodworking needs. You will have exactly what you need within hand's reach.

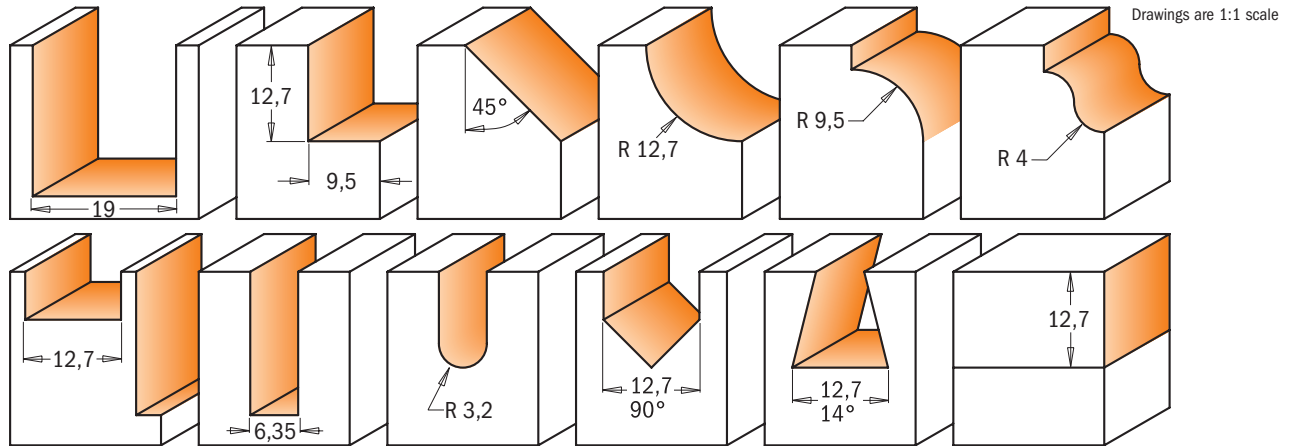

DESCRIPTION

12 piece router bit set with wooden case

ORDER NO.
S=Ø6,35mm
800.503.11

13 piece router bit set with wooden case



800.505



Containing 13 of CMT's most frequently used 12,7mm shank router bits featuring the finest steel and carbide, plus CMT's baked-on orange PTFE non-stick coating, this compact Italian hardwood case is beautiful and convenient for your woodworking needs. You will have exactly what you need within hand's reach.

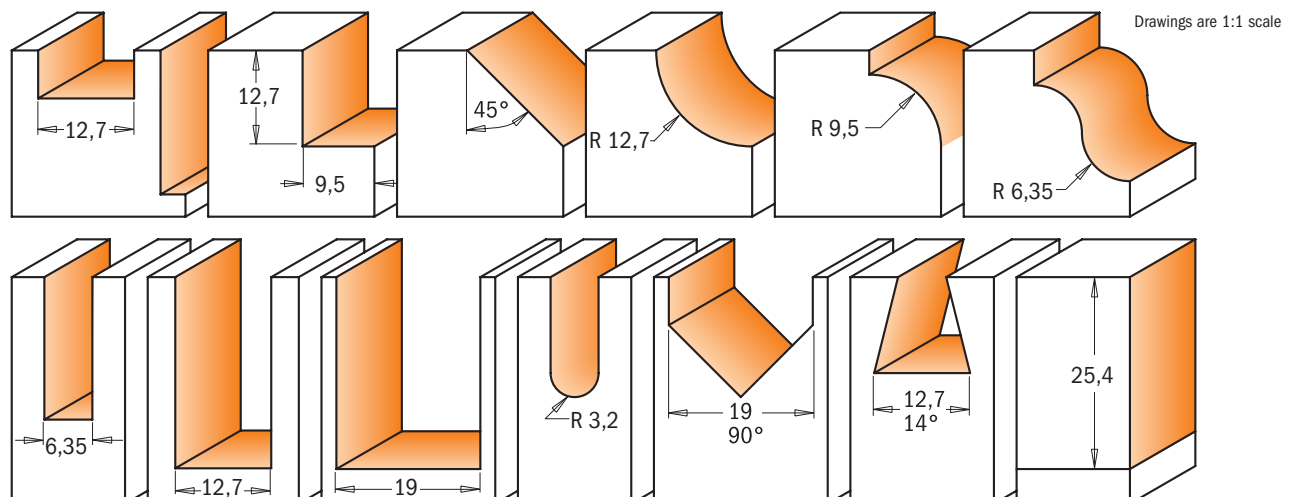

DESCRIPTION

13 piece router bit set with wooden case

ORDER NO.
S=Ø12,7mm
800.505.11

6 piece profile bit set with wooden case



800.504

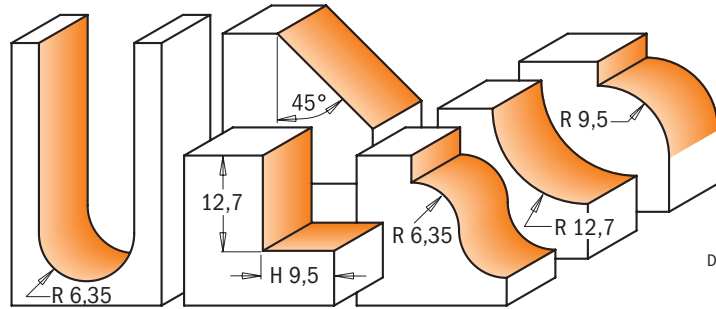

Drawings are 1:1 scale

Containing 6 of CMT's most frequently used 12,7mm shank router bits, this compact Italian hardwood case is beautiful and convenient for your woodworking needs. All the bits contained feature the finest steel and carbide, plus CMT's baked-on orange PTFE non-stick coating.

DESCRIPTION	ORDER NO.
6 piece profile bit set with wooden case	S=Ø12,7mm 800.504.11

Entry & interior door router bit set



8/900.527

This CMT three-piece router bit set simplifies door construction, making it easy as 1, 2, 3! It is not the only advantage, in fact this is a multifunctional set for door and furniture makers, building entry or passage doors and any furniture tenons. The included tenon cutter produces a beefy 27mm long tenon. Coupled with the cope cutter, you can produce long and strong tenons with minimum setup. As an extra bonus the tenon cutter can be used for furniture making requiring any tenon from 4,7mm to 16mm thick.



Entry & interior door construction Easy as 1, 2, 3!

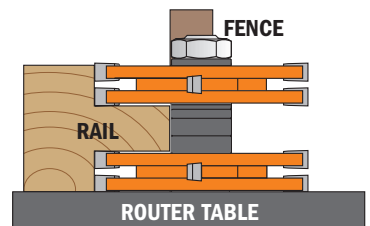

Step 1. Cut the tenon into the rails

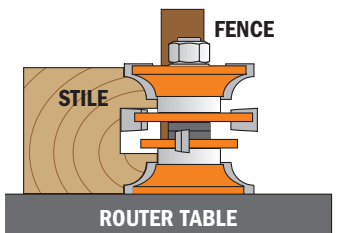

Step 2. Cut the groove and door profile in pieces.

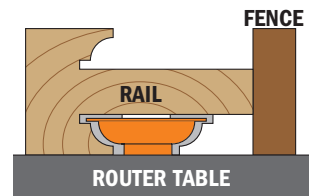

Step 3. Undercut the tenons to cope the ends of the rails.

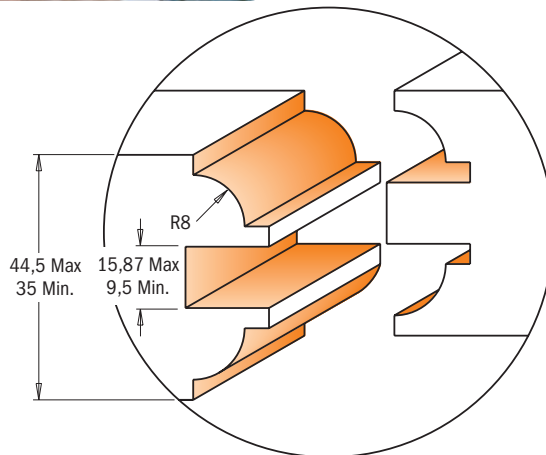
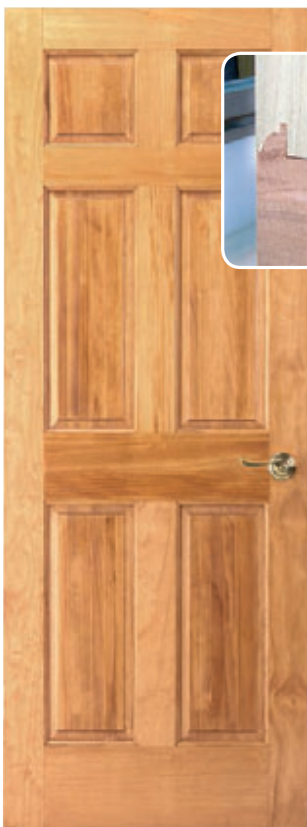

DESCRIPTION	ORDER NO.	ORDER NO.
3 piece entry & interior door router bit set	S=Ø12mm 900.527.11	S=Ø12,7mm 800.527.11

2-piece entry door router bit set

new

CMT ORANGE TOOLS™

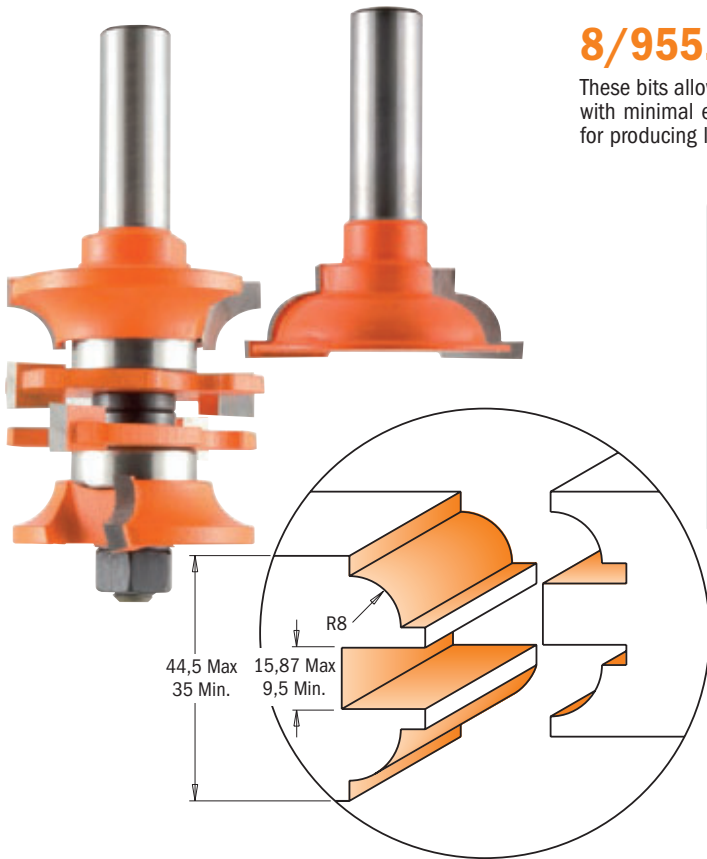

8/955.806



These bits allow you to create tongue-and-groove joints and produce entry and passage doors with minimal effort. The bit on the left, when used in pair with the bit 800.628.11, is great for producing long and beefy tenons, whereas the other tool makes the decorating profile.

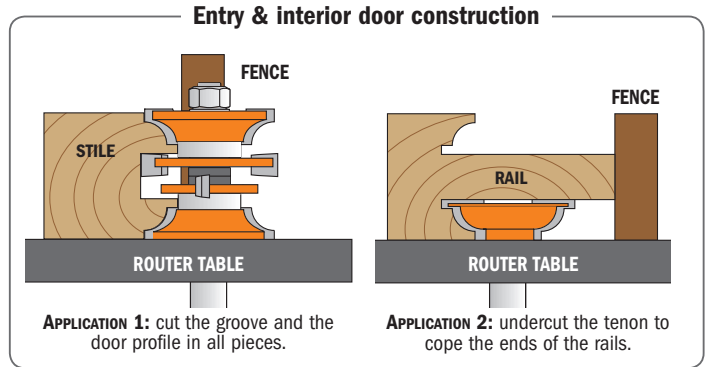

D mm	I mm	ORDER NO. S=Ø12mm	ORDER NO. S=Ø12,7mm	Spare parts							
44,5-48	35-44,5	955.806.11	855.806.11	8-22mm	up	down		0,1mm	0,3mm	3mm	
				791.005.00	822.021.11A	822.021.11B	822.022.11	541.515.00	541.516.00	541.500.00	990.020.00

Tenon cutting router bits

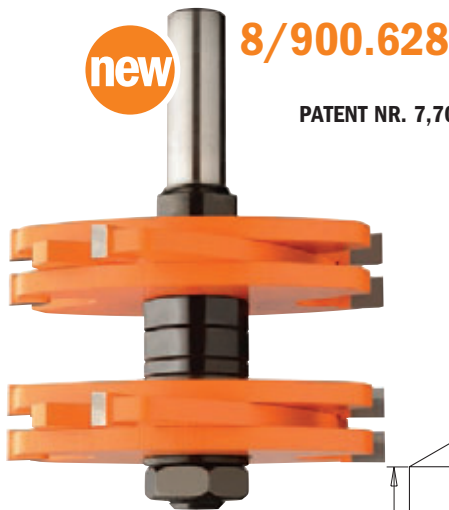

8/900.628

PATENT NR. 7,703,605 B2



8/900.627



If you've struggled cutting fitting tenons, here's the perfect solution for you. CMT's tenon cutting router bit will produce perfectly fitting tenons in every board you cut, even if the boards vary slightly in thickness. Simply set the distance between the cutters using the included spacers, and you can easily cut tenons from 4,76mm (3/16") to 9,5mm (3/8") thick, up to 27mm (1-1/16") long. This simple-to-use router bit takes the mystery out of achieving the excellent tenon-to-mortise fit required for high quality joinery.

8-900.627

T ₁	Spacers (mm)		
	6,35mm	3,2mm	1,6mm
4,76mm	1	0	0
6,35mm	1	0	1
8mm	1	1	0
9,5mm	1	1	1

Maximum speed
MAX RPM 12.000

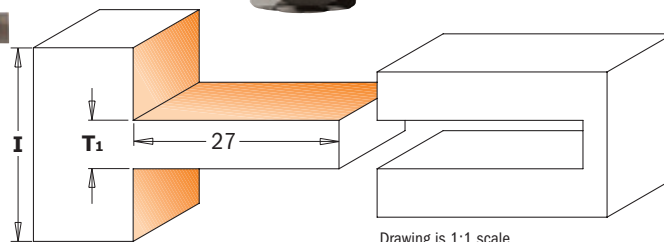

D mm	I mm	T ₁ mm	ORDER NO. S=Ø12mm	ORDER NO. S=Ø12,7mm	Spare parts								
75	34,9	4,76-9,5	900.627.11					0,1mm	0,3mm	1,6mm	3,2mm	6,2mm	
75	34,9	4,76-9,5		800.627.11	924.134.00	822.020.11	541.513.00	541.520.00	541.521.00	541.522.00	541.523.00	990.022.00	
75	34,9	4,76-9,5		800.627.11	824.134.00	822.020.11	541.513.00	541.520.00	541.521.00	541.522.00	541.523.00	990.022.00	
75	44,5	9,5-15,8	900.628.11		924.135.00	822.020.11	541.513.00	541.520.00	541.521.00	541.522.00	541.523.00	990.022.00	
75	44,5	9,5-15,8		800.628.11	824.135.00	822.020.11	541.513.00	541.520.00	541.521.00	541.522.00	541.523.00	990.022.00	

Slot cutter sets



8/923.001

Create slots, grooves and rabbets on all materials using the CMT slot cutter sets. Ideal for biscuit and tongue and groove joints. **These sets include 4 different bearings to allow a cutting depth of 7,95mm, 9,5mm, 12,8mm and 14,3mm.** Please refer to the chart below for applications and the correct cutter combinations.

Safety tips: never use the slot cutter sets without shims between cutters, whose distance can vary from 1mm to 1,7mm. Shims can also be positioned between the ball bearings and the cutters.



Assembly illustration

924.081.10 S=8mm
824.121.10 S=12,7mm
924.082.10 S=8mm
824.122.10 S=12,7mm
924.080.10 S=8mm
824.127.10 S=12,7mm
924.083.10 S=8mm
824.128.10 S=12,7mm

47,6

H

Spare parts		
H mm		ORDER NO.
14,3	8-19	791.033.00
12,7	8-22	791.005.00
9,5	8-28,5	791.030.00
8	8-31,5	791.033.00

DESCRIPTION	ORDER NO.	Spare parts									
	S=Ø8mm										
Set	923.001.11	822.320.11	823.330.11	823.340.11	823.350.11	822.360.11	924.081.10	924.082.10	924.080.10	924.083.10	

DESCRIPTION	ORDER NO.	Spare parts									
	S=Ø12,7mm										
Set	823.001.11	822.316.11	823.332.11	823.340.11	823.348.11	822.364.11	824.121.10	824.122.10	824.127.10	824.128.10	

5 piece straight bit set and profile bit set

Our beautiful sets are the perfect companion for the professional craftsman. We offer three 5 piece sets with a selection of straight bits and the most popular profile router bits. These tools feature Fatigue Proof® steel, micrograin carbide and orange PTFE non-stick coating. Safely stored in a solid plastic box to fit in your display cabinet.



8/900.005.01

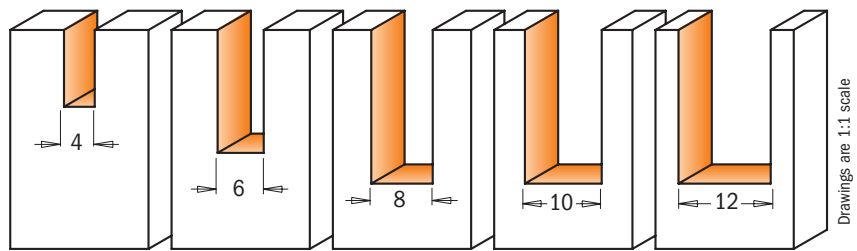

DESCRIPTION	ORDER NO.	ORDER NO.
	S=Ø6,35mm	S=Ø8mm
5 piece straight bit set	800.005.01	900.005.01

7/900.005.03

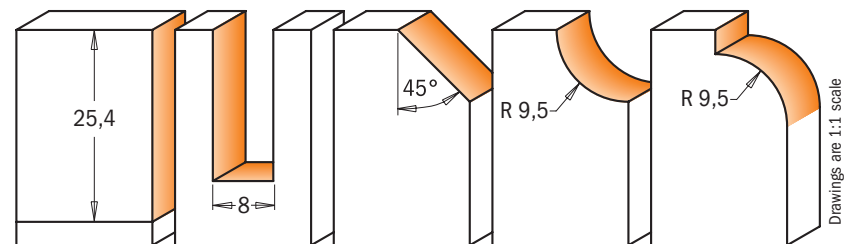

DESCRIPTION	ORDER NO.	ORDER NO.
	S=Ø6mm	S=Ø8mm
5 piece profile bit set	700.005.03	900.005.03

Saw blades
Jig saw blades
Tools with bore & Knives
Router bits & sets
CNC router cutter & chucks
Industrial dowel drills
Bits for hand power tools
Power tools & accessories
Display cabinets & spare parts

Router bit set with insert knives



600.005.01



This set is the perfect companion for the professional craftsman. We offer the 5 most popular bits with knives and all necessary spare knives and Torx keys. They are perfect for working on all materials such as solid wood, wood composites, plastic and laminated materials. For use with a hand held or CNC router.

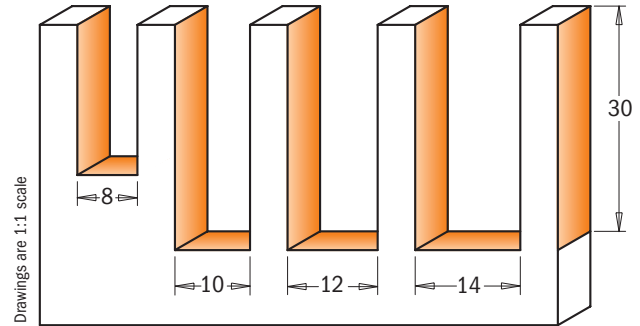

DESCRIPTION	ORDER NO.
Router bit set with insert knives	S=Ø8mm 600.005.01

10 spare knives and 2 torx keys included

Set contains	D mm	I mm	Spare knives	ORDER NO. S=Ø8mm
Straight router bit with knife	8	20	790.200.01 - 20 x 4,1 x 1,1mm	651.080.11
Straight router bit with knife	10	30	790.300.01 - 30 x 5,5 x 1,1mm	651.100.11
Straight router bit with knife	12	30	790.300.01 - 30 x 5,5 x 1,1mm	651.120.11
Straight router bit with knife	14	30	790.300.01 - 30 x 5,5 x 1,1mm	651.140.11
Flush trim bit with knife	19	30	790.300.00 - 30 x 12 x 1,5mm	791.007.00 657.191.11

5 piece spiral bit sets



191
Upcut

192
Downcut



191/192



CMT is proud to offer you these new sets of high quality solid tungsten carbide upcut and downcut spiral bits in the most popular diameters. The new formulated super micrograin composition guarantees extremely sharp long-lasting cutting edges, whereas the spiral layout allows for a more efficient chip ejection. In addition these bits stay cooler during work and are suitable for CMT's new precision machines. Recommended for use on soft and hardwood, plywood, laminates, MDF and plastic materials. To be used on handheld routers and CNC machines.

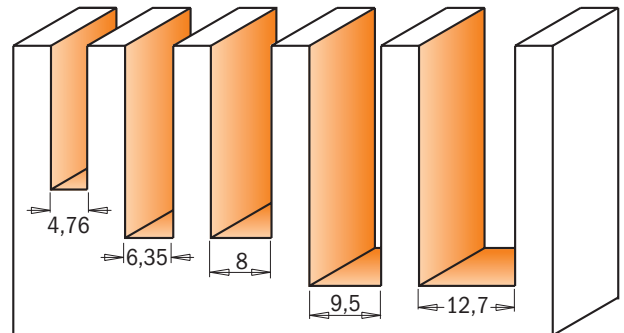
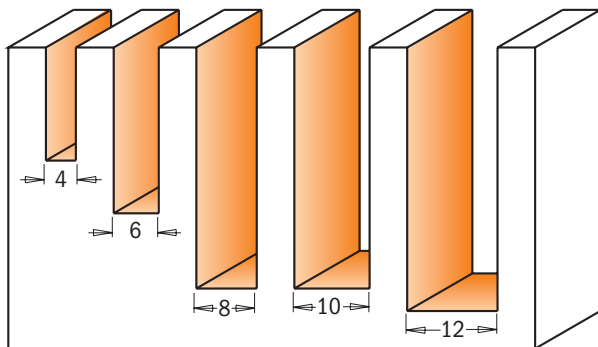
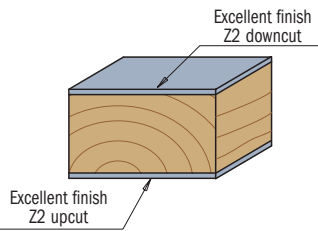

Drawings are 1:1 scale

DESCRIPTION	ORDER NO. S=Ø8mm	ORDER NO. S=Ø6,35-12,7mm
5 piece upcut spiral bit sets (Ø4 - 6 - 8 - 10 - 12mm)	191.000.01	
5 piece downcut spiral bit sets (Ø4 - 6 - 8 - 10 - 12mm)	192.000.01	
5 piece upcut spiral bit sets (Ø4,76 - 6,35 - 8 - 9,5 - 12,7mm)		191.000.02
5 piece downcut spiral bit sets (Ø4,76 - 6,35 - 8 - 9,5 - 12,7mm)		192.000.02

CMT's complete kitchen set



These CMT's sets aren't only a random selection of odds and ends packaged in a nice elegant box, but they are also professional kits for drawer and door makers. 3 sets to choose from, 5 different bits to suit your needs: a raised panel bit, rail and stile bits, a glue joint and a drawer lock bit. Please refer to the illustrations below for complete profile options.

Drawings are 1:1 scale

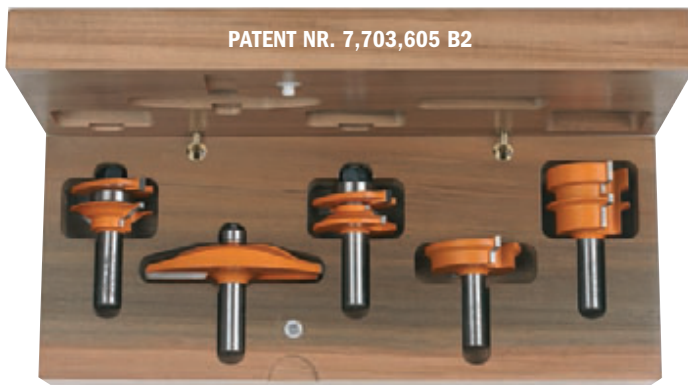

8/900.509.11

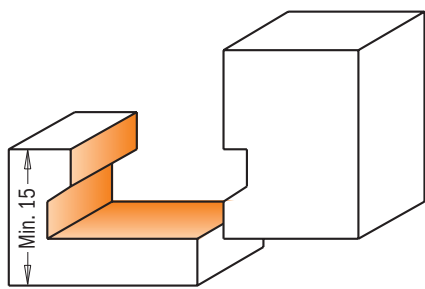
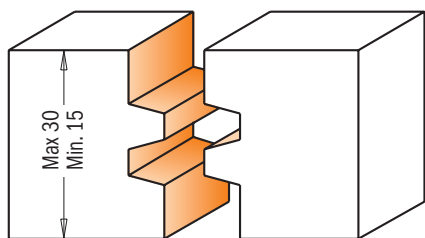
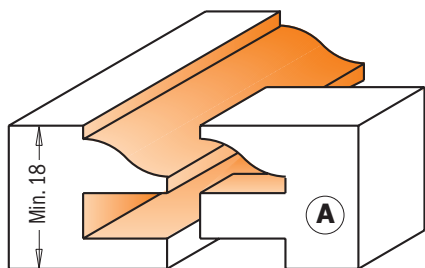
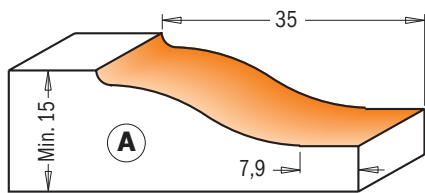

8/900.510.11

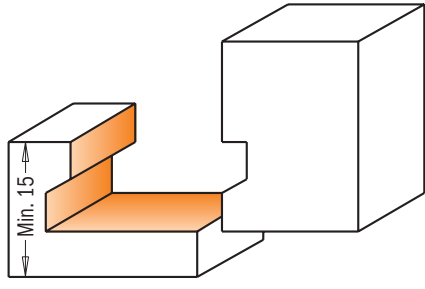
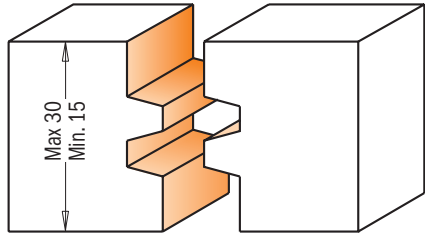
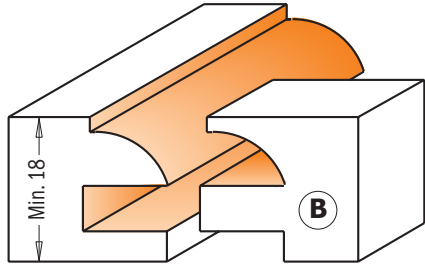
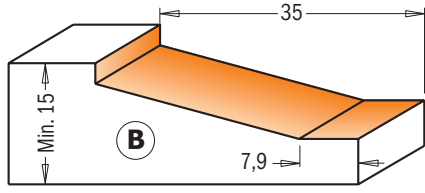

8/900.511.11

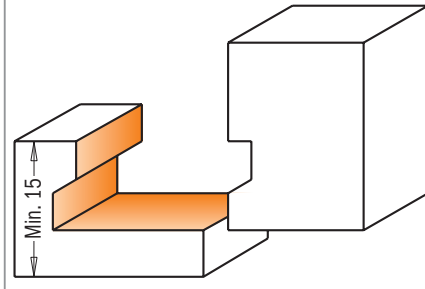
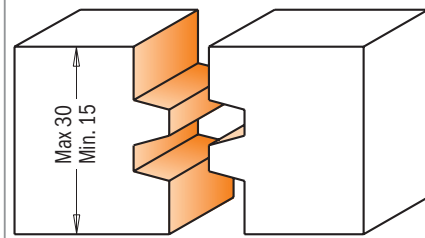
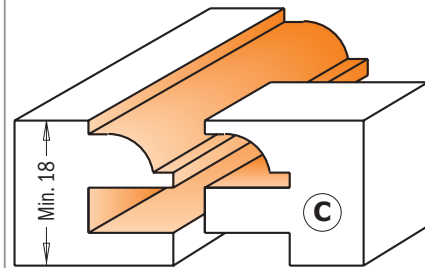
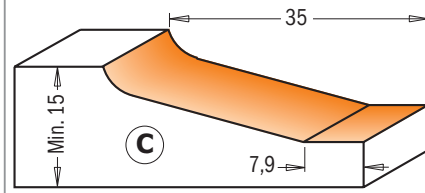

DESCRIPTION	ORDER NO.	ORDER NO.
	S=Ø12mm	S=Ø12,7mm
CMT's complete kitchen set - Profile A (5 HW pcs.)	900.509.11	800.509.11
CMT's complete kitchen set - Profile B (5 HW pcs.)	900.510.11	800.510.11
CMT's complete kitchen set - Profile C (5 HW pcs.)	900.511.11	800.511.11

Panalign strips



Beautiful panel doors can be ruined by a poorly-aligned panel. Next time, slip panalign strips into the rails to keep panels perfectly centred while allowing for expansion. Unlike carpet foam, which eventually loses elasticity and ceases to work, the rubber in panalign strips is specially designed to spring back indefinitely. The rectangular shape makes the strips easy to handle. Typical doors require 4 to 8 strips each.

PNL

DESCRIPTION	ORDER NO.
Panalign strips Q.ty 200	PNL-001

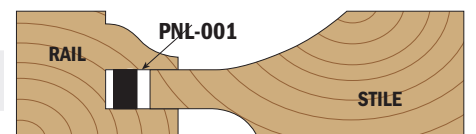

Saw blades
Jig saw blades
Tools with bore & Knives
Router bits & sets
CNC router cutter & chucks
Industrial dowel drills
Bits for hand power tools
Power tools & accessories
Display cabinets & spare parts



Open new doors with CMT! Our 3 piece kitchen sets include a couple of rail and style bits and a raised panel bit. Choose among 4 possible profiles to make panel doors easy and economical. Each bit is made from bar stock steel and the highest quality tungsten carbide, along with the trademark orange non-stick PTFE coating. Also, they all come with their protective hardwood case: a very nice object to keep your bits safe, organized and within hand's reach.

Drawings are 1:1 scale

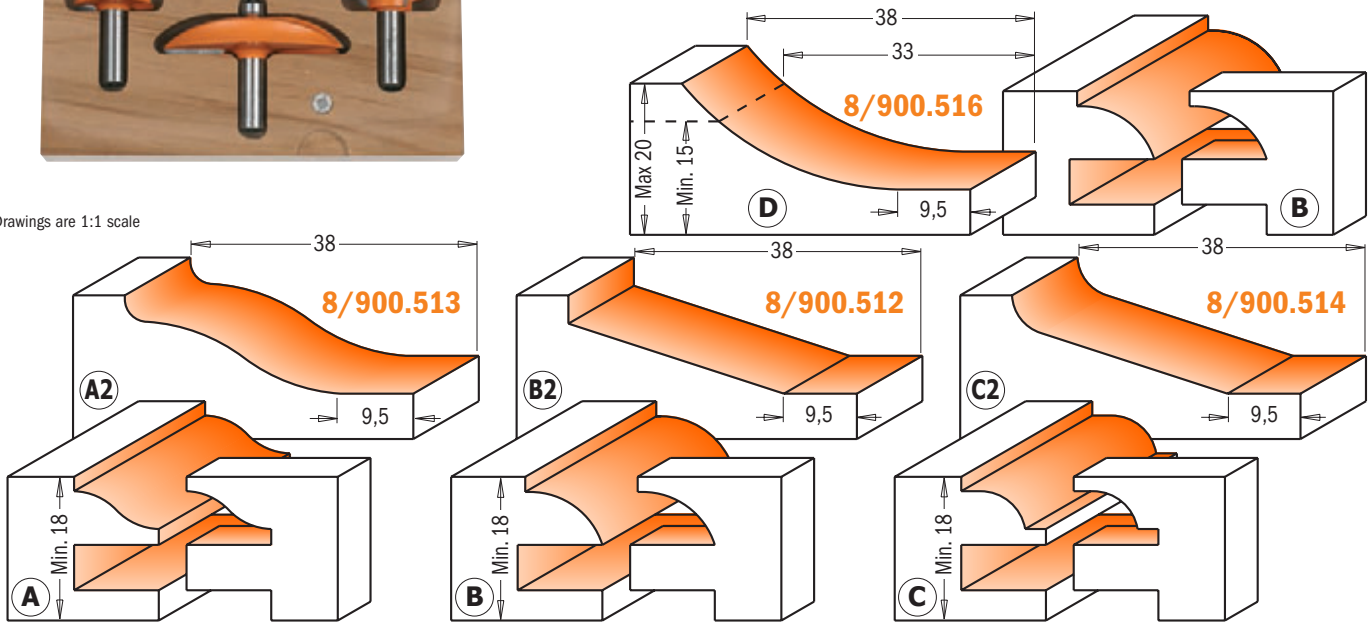

DESCRIPTION	ORDER NO. S=Ø12mm	ORDER NO. S=Ø12,7mm
Kitchen set - Profile A+A ₂	900.513.11	800.513.11
Kitchen set - Profile B+B ₂	900.512.11	800.512.11
Kitchen set - Profile C+C ₂	900.514.11	800.514.11
Kitchen set - Profile D+B	900.516.11	800.516.11

The raised panel sets with backcutter



8/900.518 - 8/900.522

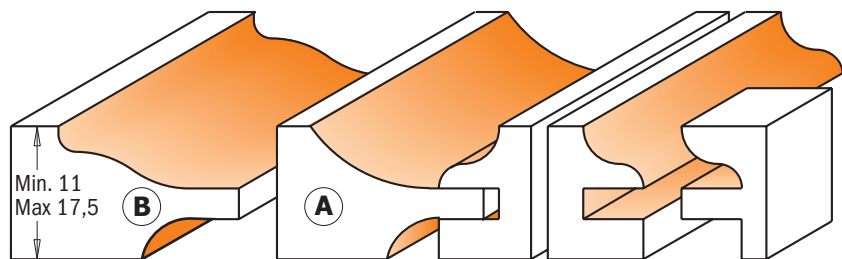

8/900.517 - 8/900.521

Drawings are 1:1 scale

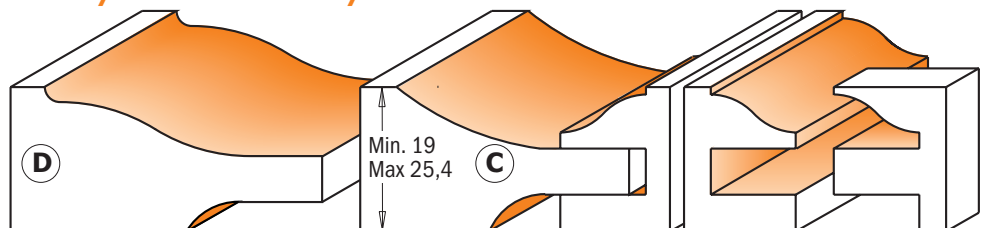

CMT's junior raised panel sets add intricate detail on a whole new scale! You will make frame and panel details as small as 70mm square in material as thin as 11mm. Delicate panel doors are only the beginning - use these bits with templates to add interesting arches to your work. The sets include a choice of a cove or an ogee raised panel bit and an ogee rail & stile pair. Packaged in beautiful hardwood cases.

DESCRIPTION	ORDER NO. S=Ø12mm	ORDER NO. S=Ø12,7mm
The junior raised panel sets - Profile A (3 HW pcs.) Ø63,5mm.	900.518.11	800.518.11
The junior raised panel sets - Profile B (3 HW pcs.) Ø63,5mm.	900.522.11	800.522.11
The raised panel sets - Profile C (3 HW pcs.) Ø89mm.	900.517.11	800.517.11
The raised panel sets - Profile D (3 HW pcs.) Ø89mm.	900.521.11	800.521.11

The cabinetmaking sets

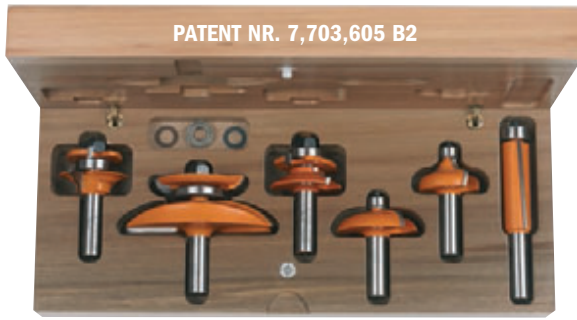

800.515 - 800.520



Available with raised panel bits in two different profiles, these sets feature six router bits for making arched raised panel doors and professional drawer fronts.

These sets include:

OGEE RAIL & STILE BITS: these two perfectly matched tools will eliminate the frustration of setting up reversible cutters. The stile bits also feature shear angles for neater cuts.

RAISED PANEL BIT WITH BACKCUTTER: this 88,9mm diameter bit features a backcutter for milling both the front and the back on the panel in a single cut. We recommend using a 31mm diameter bearing to work safely in two shallow passes.

SUPER-DUTY FLUSH TRIM BIT: this 19mm diameter bit gives you a superior cut with minimal chipping, even on end grain.

OGEE DOOR EDGE BIT: a subtle cove followed by a subtle roundover adds an elegant touch to your door edge.

DRAWER FRONT BIT: this bit makes a mini-raised panel cut on the outside edges of your drawer fronts.

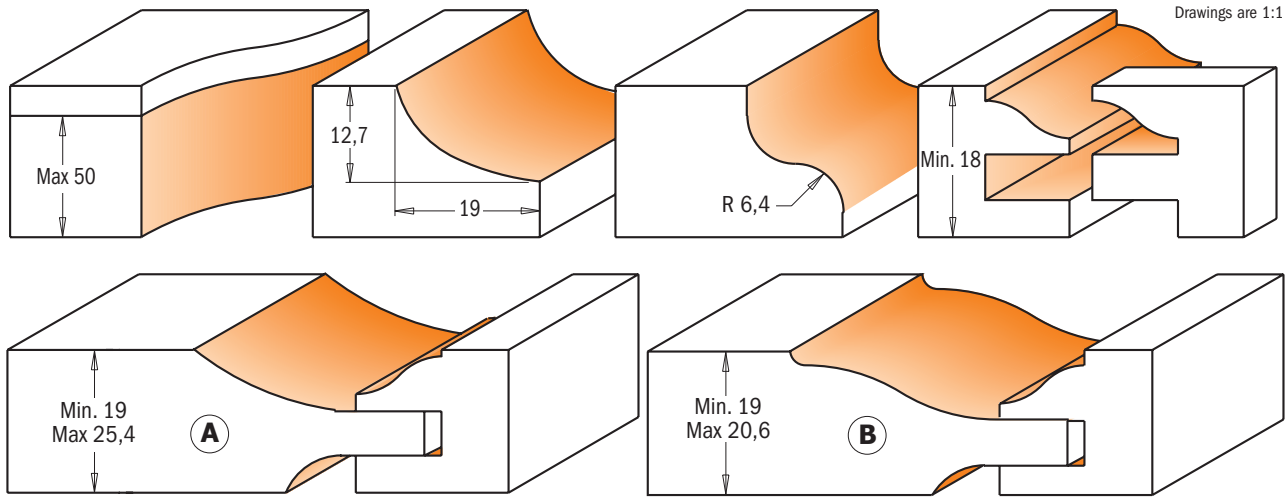

Drawings are 1:1 scale

DESCRIPTION	ORDER NO.
The cabinetmaking sets - Profile A (6 HW pcs.)	S=Ø12,7mm 800.515.11
The cabinetmaking sets - Profile B (6 HW pcs.)	800.520.11

Small arch door sets

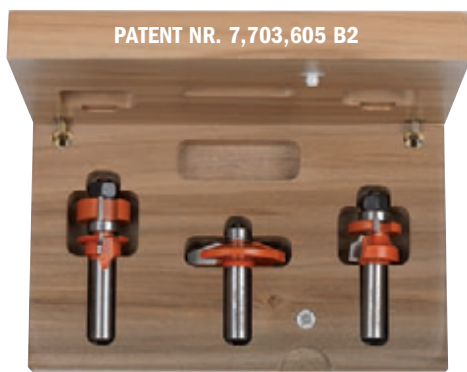

800.524 - 900.024



These 3 piece sets will produce beautiful raised panel doors with a classic bevelled profile. Designed for use in fine furniture making, these sets include two matched cope and stick bits to produce frames from 15,87mm to 19mm in thickness. The stick bit shapes a decorative 4,76mm thumbnail moulding along the edge of the frame.

The panel bit is designed for 12,7mm thick material. All bits are equipped with guide bearings for shaping curved work such as the small arched panel doors seen on secretaries and corner cabinetry. These sets also produce panels for small chests, lids for small boxes, or drawer fronts. Instructions included.

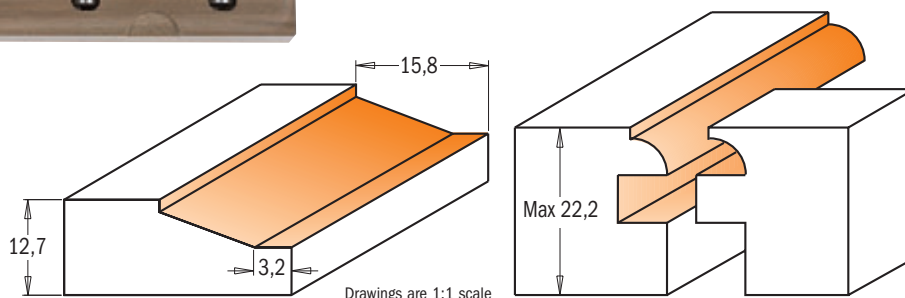

DESCRIPTION	ORDER NO.	ORDER NO.
Small arch door sets (3 HW pcs.)	S=Ø8mm 900.024.11	S=Ø12,7mm 800.524.11

Saw blades
Jig saw blades
Tools with bore & Knives
Router bits & sets
CNC router cutter & chucks
Industrial dowel drills
Bits for hand power tools
Power tools & accessories
Display cabinets & spare parts

Divided light door sets

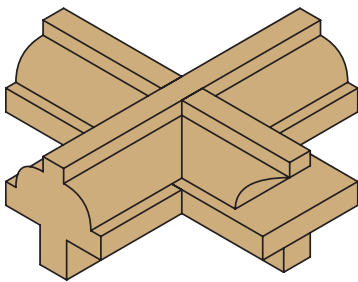

800.525 - 900.025



Build authentic divided light doors for fine furniture and cabinets with these 3 piece sets. They include a stuck bit to cut the decorative ovolo profile on the frame edges, a cope to shape the mating profile on the ends of the stock, and a rabbeting bit to cut the recess for the glass. Thanks to the guide bearings, you can also create arched on curved frames. The unique design of the cope bit allows you to use full-length tenons to create strong, authentic mortise-and-tenon joinery. As the stock is coped, the tenon passes over the bit. These sets are designed for 22,2mm wide bars such as those on corner cupboard door. Available in 8mm and 12,7mm shanks. Instructions included.

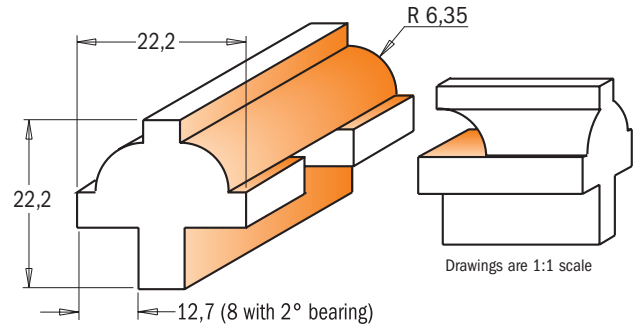

DESCRIPTION	ORDER NO. S=Ø8mm	ORDER NO. S=Ø12,7mm
Divided light door sets	900.025.11	800.525.11

Glass panel sets

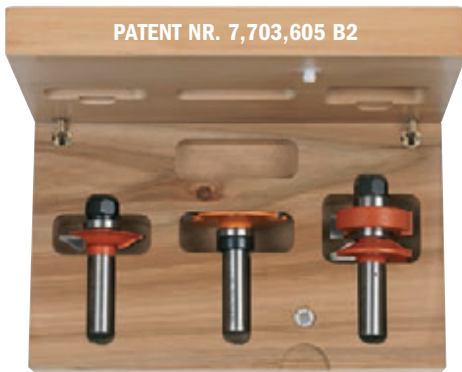

8/955.803

CMT's unique stile and rail router bit sets allow you to produce glass panel doors by using a rubber panel retainer to secure the glass in a 3,2mm slot cut into the frames. These bits work the same as other CMT's stile and rail sets, but they leave you with a square rabbet on the inside of your door for installing the glass panel. Available in 12mm and 12,7mm shanks.

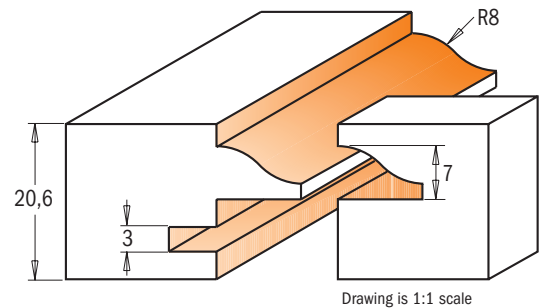

Glass panel retainers

new

HERE'S HOW IT WORKS:

Mill the cope and pattern cuts first, then use the slot cutter to cut the groove for the rubber panel retainer. The edge of the pattern cut will ride on the bearing of the slot cutter bit. When you cut the slot in the rails you can cut the slot the full length of the stock. When you cut the slot in the stiles you need to set up reference points to stop and start the cuts so they are hidden from view on the top and bottom of the doors.

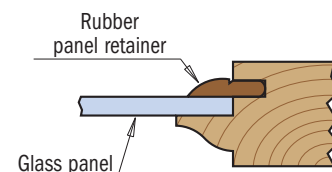
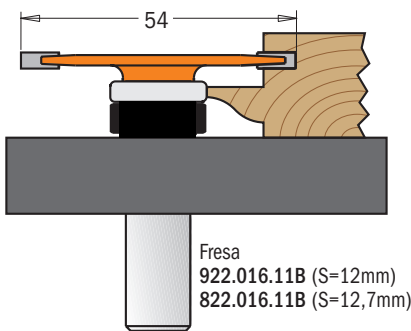

GLAS/RTBRN



Our unique retainer strips fit perfectly in the slots created by the slot cutter bit and hold your glass securely in the frame. Sold in 23 metre (25') lengths.

DESCRIPTION	ORDER NO. S=Ø12mm	ORDER NO. S=Ø12,7mm
Glass panel sets	955.803.11	855.803.11

Saw blades
Jig saw blades
Tools with bore & Knives
Router bits & sets
CNC router cutter & chucks
Industrial dowel drills
Bits for hand power tools
Power tools & accessories
Display cabinets & spare parts

Adjustable shaker router bit sets

new

CMT ORANGE TOOLS™



8/900.624



These new bit sets are excellent for producing adjustable tongue and groove joints with a bevel, in order to eliminate the panel rattle that may come up with the production of standards cabinets. Cut precise grooves into your plywood veneered panels and make perfect rattle-free fits. To be used on table-mounted routers. Avoid using these bits in hand-held power tools.

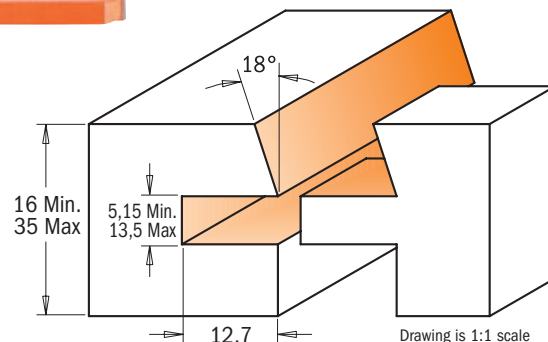
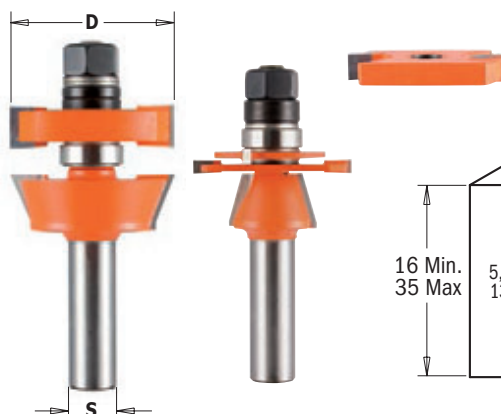
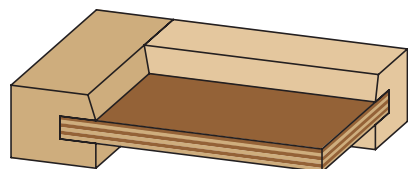

D mm	T ₁ mm	A	L mm	ORDER NO. S=Ø12mm	ORDER NO. S=Ø12,7mm	Spare parts					
41,2	16 - 35	18°	87	900.624.11	800.624.11						
				541.515.00 0,1mm spacer	541.518.00 1mm spacer						
				541.516.00 0,3mm spacer	541.500.00 3mm spacer						
				541.517.00 0,5mm spacer	541.519.00 5,8mm spacer						

Spare parts

Adjustable tongue & groove bit set for mission style cabinet doors



8/900.625



Exclusive CMT design which allows the perfect fit for undersized plywood panel. The tongue cutter features opposing shear angles to obtain flawless finishing on a large variety of material such as plywood, softwood and hardwood.

For use on a table-mounted router, not for handheld routers.

- Adjustable at 0.050mm (0.002") increments;
- For groove width from 5mm (13/64") to 13,5mm (17/32");
- Cut stock thickness of 12,7mm (1/2") to 31,7mm (1-1/4");
- Features micrograin carbide for longer life.

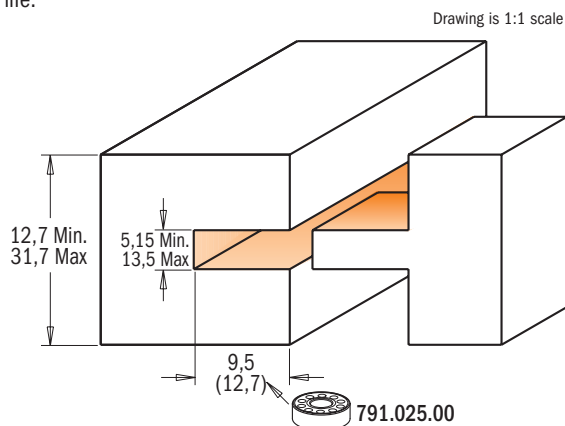
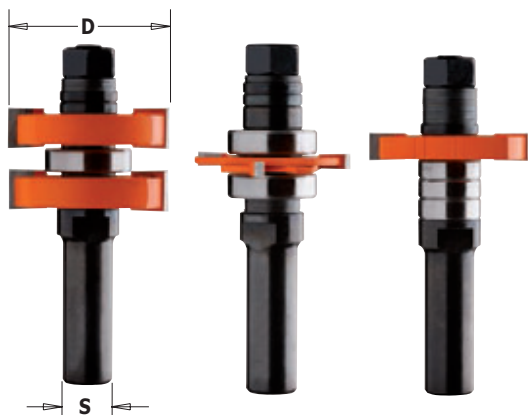
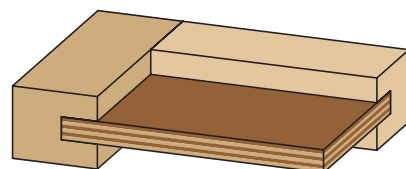

D mm	T ₁ mm	ORDER NO. S=Ø12mm	ORDER NO. S=Ø12,7mm	Spare parts						
41,2	5,15-13,5	900.625.11	800.625.11							
41,2	5,15-13,5			924.136.00	791.012.00	822.025.11	822.026.11	822.027.11	822.028.11	990.020.00
				824.136.00	791.012.00	822.025.11	822.026.11	822.027.11	822.028.11	990.020.00

Spare parts

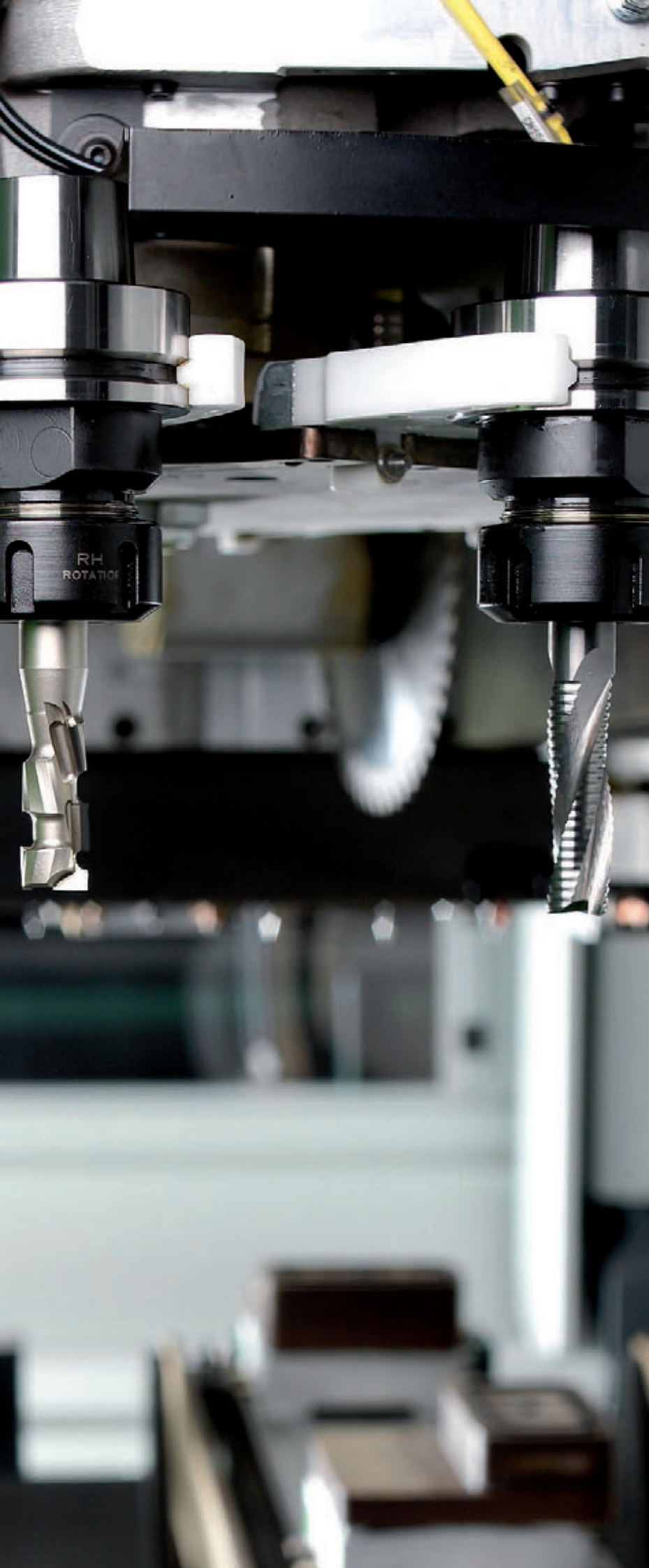

CNC router cutters & chucks

PRODUCTS	PAGE
Universal assembly supports for chucks	190
CNC chucks	190 ~ 194
Precision collets	194- 195
Cutter arbor	196 - 197
MK2 chucks	197
Solid carbide spiral bits	198 ~ 204
CNC straight cutters	205 ~ 213
CNC profiled cutters	213 ~ 217
Slot & mortise bits	218 ~ 224

Precision chucks and collets

The ideal accessories for machining centres, point-to-point machines and CNC routers.

- extreme precision and reliability;
- perfect tool centering;
- defect-free rotation;
- made from extremely high resistant steel;
- precision grinding on all jointed parts;
- extreme high rotation performance >= 15 HP – 20.000 RPM;
- for very efficient sizing on extreme unprecedented high feed speed;
- excellent finishing quality on the workpiece and longer tool life;
- sturdy design with reduced height to increase the work space between the machine and the piece;
- safe and fast tool setup;
- interchangeable collet clamps with radial grooves for secure parallel tool clamping;
- wide clamping tolerance (-0.7mm);
- right or left-hand rotation chucks with self clamping threads;
- clamping nut with Woodruff radial grooves for c-spanners;
- practical withdrawal sleeves with double differential threads for the chuck spindle;
- central hexagonal low profile for easy tool clamping through a c-spanner;
- designed and tested in collaboration with the most renowned machining and CNC router construction centres;
- delivered in a smart professional packaging.

Universal assembly supports for chucks



183

DESCRIPTION	D mm	ORDER NO.
Universal assembly supports for chucks HSK-F63	63	183-HSK
Universal assembly supports for chucks ISO30	50	183-ISO

For HSK-F63 and ISO30 chucks

CMT now offers new universal assembly supports for HSK-F63 and ISO30 chucks. Thanks to the bidirectional roller bearings, which clamp the tool to the flange, the system offers the highest protection to the tool taper and clamps are no longer needed.

The special bidirectional roller bearing clamps the tool to the flange, offering the highest protection to the tool taper.

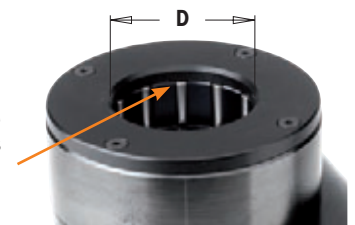

HSK chuck for “ER32” precision collets



183.300

RH LH

S	DESCRIPTION	To be used with collet	ORDER NO. Right-hand rotation	ORDER NO. Left-hand rotation
HSK-F63	Clamping nut without bearing	ER32	183.300.01	183.300.02
new HSK-F63	Clamping nut with bearing	ER32	183.300.11*	

* Suitable for right-hand and left-hand rotation.

For Homag, Eima from 9/94, Dubus, Weeke, Biesse, SCM, Morbidelli and Masterwood machines.

ISO30 chucks for "ER32" precision collets

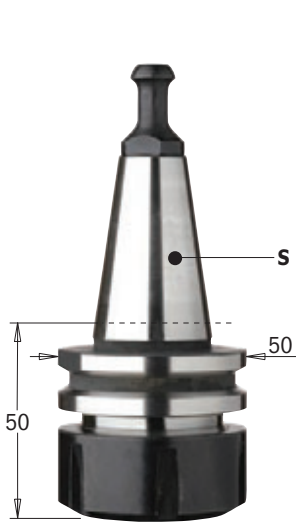

995.200

183.200

RH LH

S	To be used with collet	Retaining stud mm	ORDER NO. Right-hand rotation	ORDER NO. Left-hand rotation
ISO 30	ER32	Ø12-8	183.200.01	183.200.02

For Biesse machines.



995.201

183.210

RH LH

S	To be used with collet	Retaining stud mm	ORDER NO. Right-hand rotation	ORDER NO. Left-hand rotation
ISO 30	ER32	Ø13-9	183.210.01	183.210.02

For Biesse machines with Omlat engine, Bulleri, Busellato, CMS and IMA machines.



995.202

183.220

RH LH

S	To be used with collet	Retaining stud mm	ORDER NO. Right-hand rotation	ORDER NO. Left-hand rotation
ISO 30	ER32	Ø12,8-9	183.220.01	183.220.02

For Alberti and Masterwood machines.

ISO30 chucks for "ER32" precision collets



995.250

183.250

RH LH

S	To be used with collet	Retaining stud mm	ORDER NO. Right-hand rotation	ORDER NO. Left-hand rotation
ISO 30	ER32	Ø8,5	183.250.01	183.250.02

For Morbidelli and SCM machines.

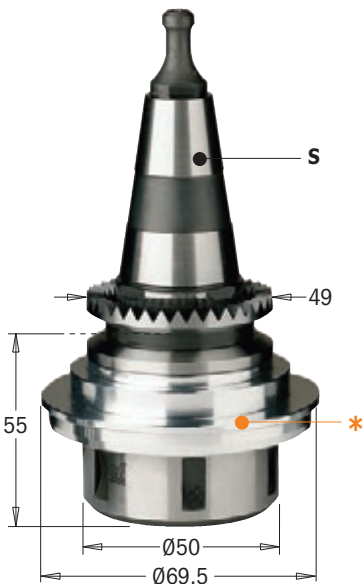

183.251

RH LH

S	To be used with collet	Retaining stud mm	ORDER NO. Right-hand rotation	ORDER NO. Left-hand rotation
ISO 30	ER32	Ø8,5	183.251.01	183.251.02

For Morbidelli and SCM machines (with aluminium flange already assembled Ø69,5mm).

*Retaining stud and aluminium flange

DESCRIPTION	ORDER NO.
Ø69,5mm aluminium flange	992.501.00

Chucks for “ER32” precision collets

Saw blades

Jig saw blades

Tools with bore & Knives

Router bits & sets

CNC router cutter & chucks

Industrial dowel drills

Bits for hand power tools

Power tools & accessories

Display cabinets & spare parts

192

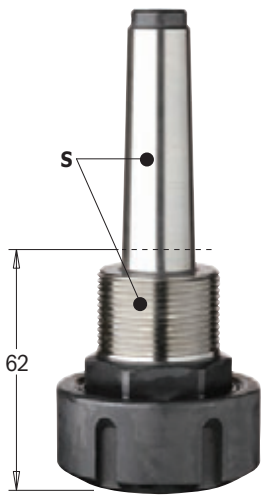
183.000/100
RH LH

S mm	To be used with collet	ORDER NO. Right-hand rotation	ORDER NO. Left-hand rotation
MK2/M30x1,5	ER32	183.000.01	183.000.02
MK3/M30x1,5	ER32	183.100.01	

MK2/MK3 tapered shank

Chucks for “ER32” precision collets

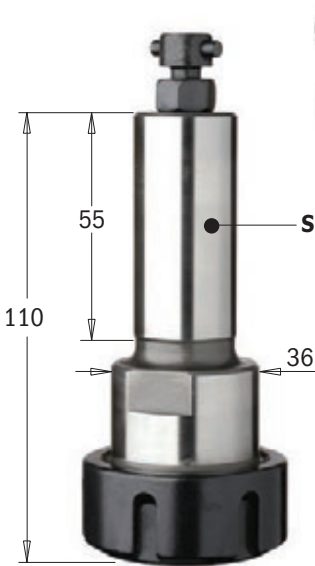

995.400

183.400
RH

S mm	To be used with collet	Retaining stud mm	ORDER NO. Right-hand rotation
Ø25x55	ER32	PS LEUCO	183.400.01

For machines with PS Leuco system.

Clamping nuts for chucks with “ER32” collets

992.183
RH LH

DESCRIPTION	ORDER NO. Right-hand rotation	ORDER NO. Left-hand rotation
Clamping nut without bearing For 183.000/100/200/250/300/400 chucks	992.183.01	992.183.02
Clamping nut with bearing For 183.000/100/200/250/300/400 chucks	992.183.11	992.183.12

C-Spanner for “ER32” precision collets

991.183

DESCRIPTION	ORDER NO.
C-Spanner for “ER32” precision collets	991.183.00

HSK chucks for "ER40" precision collets



183.310

RH LH

S	DESCRIPTION	To be used with collet	ORDER NO. Right-hand rotation	ORDER NO. Left-hand rotation
HSK-F63	Clamping nut without bearing	ER40	183.310.01	183.310.02
new HSK-F63	Clamping nut with bearing	ER40	183.310.11*	

* Suitable for right-hand and left-hand rotation.

For Homag, Eima, IMA from 9/94, Dubus, Weeke, Biesse, SCM, Morbidelli and Masterwood machines.

ISO30 chucks for "ER40" precision collets



995.200

183.201

RH

S	To be used with collet	Retaining stud mm	ORDER NO. Right-hand rotation
ISO30	ER40	Ø12-8	183.201.01

For Biesse machines



995.201

183.211

RH

S	To be used with collet	Retaining stud mm	ORDER NO. Right-hand rotation
ISO30	ER40	Ø13-9	183.211.01

For Biesse machines with Omlat engine, Bulleri, Busellato, CMS and IMA machines.



995.202

183.221

RH

S	To be used with collet	Retaining stud mm	ORDER NO. Right-hand rotation
ISO30	ER40	Ø12,8-9	183.221.01

For Alberti and Masterwood machines.

Clamping nuts for chucks with "ER40" precision collets



992.383

RH LH

DESCRIPTION	ORDER NO. Right-hand rotation	ORDER NO. Left-hand rotation
Clamping nut without bearing For 183.201/211/221/310 chucks	992.383.01	992.383.02
Clamping nut with bearing For 183.201/211/221/310 chucks	992.383.11	

C-spanner for "ER40" precision collets



991.184

DESCRIPTION	ORDER NO.
C-Spanner for "ER40" precision collet	991.184.00

HSK chuck for “DIN6388” precision collet

RH



183.320

S	DESCRIPTION	To be used with collet	ORDER NO. Right-hand rotation
HSK-F63	HSK chuck with bearing nut	DIN6388	183.320.01*

Spare parts 992.283.11 Clamping nut with bearing

* Suitable for left-hand rotation too.

For Homag, Eima from 9/94, Dubus, Weeke, Biesse, SCM, Morbidelli & Masterwood machines.

“DIN6388” precision collets



185

D ₃			D ₃		
mm	inches	ORDER NO.	mm	inches	ORDER NO.
6		185.060.00	14		185.140.00
8	5/16	185.080.00	16	5/8	185.160.00
10		185.100.00	18		185.180.00
12		185.120.00	20		185.200.00
13	1/2	185.130.00	25		185.250.00

REMARK: special dimensions available on request.

Clamping nuts



992.283

RH

DESCRIPTION	ORDER NO. Right-hand rotation
Clamping nut without bearing	992.283.01
Clamping nut with bearing	992.283.11

For chuck 183.320.

C-Spanner for “DIN6388” & “ER40”



991.283

DESCRIPTION	ORDER NO.
C-Spanner for “Usag” 58-62-65	991.283.00



new

184.xxx.11

D ₃ mm	ORDER NO.
2	184.020.11
3	184.030.11
4	184.040.11
5	184.050.11
6	184.060.11

TECHNICAL DETAILS:

- replaceable Std "ER11" collets (from 1 to 7mm)
- fit most tapered spindle noses
- +0-0,7mm wide clamping tolerance
- suitable for most conical chucks.

REMARK: special dimensions available on request.



new

184.xxx.16

D ₃ mm	ORDER NO.
2	184.020.16
3	184.030.16
4	184.040.16
5	184.050.16
6	184.060.16
7	184.070.16
8	184.080.16
9	184.090.16
10	184.100.16

TECHNICAL DETAILS:

- replaceable Std "ER16" collets (from 1 to 10mm)
- fit most tapered spindle noses
- +0-0,7mm wide clamping tolerance
- suitable for most conical chucks.

REMARK: special dimensions available on request.



new

184.xxx.20

D ₃ mm	ORDER NO.
3	184.030.20
5	184.050.20
6	184.060.20
6,35	184.064.20
8	184.080.20
10	184.100.20
12	184.120.20
12,7	184.127.20

TECHNICAL DETAILS:

- replaceable Std "ER20" collets (from 3 to 12,7mm)
- fit most tapered spindle noses
- +0-0,7mm wide clamping tolerance
- suitable for most conical chucks.

REMARK: special dimensions available on request.



184.xxx.25

D ₃ mm	ORDER NO.
6	184.060.25
8	184.080.25
10	184.100.25
12	184.120.25
14	184.140.25
16	184.160.25

TECHNICAL DETAILS:

- replaceable Std "ER25" collets (from 6 to 16mm)
- fit most tapered spindle noses
- +0-0,7mm wide clamping tolerance
- suitable for most conical chucks.

REMARK: special dimensions available on request.



new

184.000

D ₃ mm	ORDER NO.
3	184.030.00
4	184.040.00
5	184.050.00
6	184.060.00
6,35	184.065.00
7	184.070.00
8	184.080.00
9,52	184.095.00
10	184.100.00
12	184.120.00
13	184.130.00
14	184.140.00
16	184.160.00
18	184.180.00
19	184.190.00
20	184.200.00

Per mandrini serie
183.000/100/200/250/300/400

TECHNICAL DETAILS:

- replaceable Std "ER32" collets (from 3 to 20mm)
- fit most tapered spindle noses
- +0-0,7mm wide clamping tolerance
- suitable for most conical chucks.

REMARK: special dimensions available on request.



new

184.002

D ₃ mm	ORDER NO.
4	184.042.00
5	184.052.00
6	184.062.00
7	184.072.00
8	184.082.00
9,52	184.096.00
10	184.102.00
12	184.122.00
13	184.132.00
14	184.142.00
16	184.162.00
18	184.182.00
19	184.192.00
20	184.202.00
25	184.252.00

Per mandrini serie
183.201/211/221/310

TECHNICAL DETAILS:

- replaceable Std "ER40" collets (from 4 to 25mm)
- fit most tapered spindle noses
- +0-0,7mm wide clamping tolerance
- suitable for most conical chucks.

REMARK: special dimensions available on request.

Cap nuts for CNC machines



993.0

RH LH

Internal thread	ORDER NO. Right-hand rotation	ORDER NO. Left-hand rotation
Ø20x14Fx1"	993.020.01	993.020.02
M30x1,5	993.030.01	993.030.02

For machines with M33x3 threaded spindle nose.

Cap nuts for router machines



993.5

RH LH

Internal thread	ORDER NO. Right-hand rotation	ORDER NO. Left-hand rotation
Ø20x14Fx1"	993.520.01	993.530.01
M30x1,5	993.530.01	993.530.02

For machines with 1-1/8"x7 threaded spindle nose.

ISO30 retaining studs

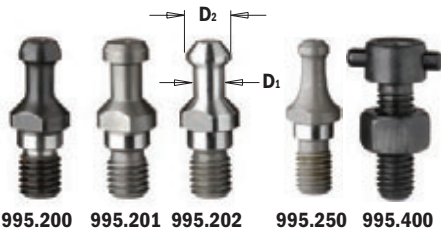

995.200 995.201 995.202 995.250 995.400

DESCRIPTION	D ₁ mm	D ₂ mm	ORDER NO.
Retaining stud for 183.200/201 "Biesse" chucks	8	12	995.200.00
Retaining stud for 183.210/211 "Biesse, Omlat, Bulleri, Busellato, CMS and IMA" chucks	9	13	995.201.00
Retaining stud for 183.220/221 "Alberti-Masterwood" chucks	9	12,8	995.202.00
Retaining stud for 183.250/251 "SCM - Morbidelli" chucks	6,5	8,5	995.250.00
Retaining stud for "PS and Leuco" 183.400 chucks	M8		995.400.00

Cutter arbor with HSK tapered shank

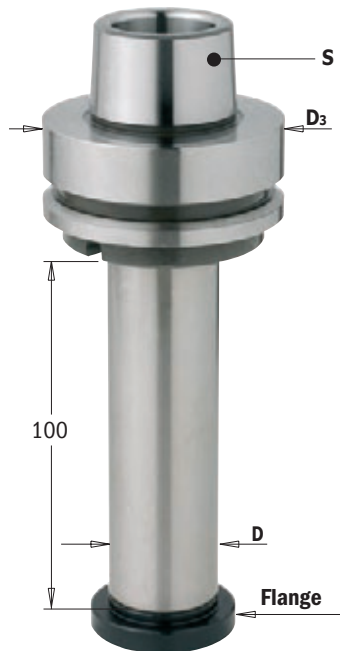

183.360

RH LH

S	D mm	D ₃ mm	ORDER NO.
HSK-F63	Ø30x100	63	183.360.00
HSK-F63	Ø35x100	63	183.361.00
HSK-F63	Ø40x100	63	183.362.00

For Homag, Eima from 9/94, Dubus, Weeke, Biesse, SCM, Morbidelli and Masterwood machines.

Cutter arbor with ISO30 tapered shank



183.260

RH LH

S	D mm	D ₃ mm	ORDER NO.
ISO 30	Ø30x100	50	183.260.00

For Biesse machines.

REMARK: special dimensions available on request.

Spare parts for chucks

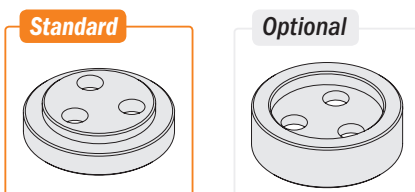

DESCRIPTION	ORDER NO.	DESCRIPTION	ORDER NO.
M6x25 TCEI screw	990.098.00	<i>Optional</i>	
Steel flange for with Ø30mm arbors - Male	992.560.30M	Steel flange for with Ø30mm arbors - Female	992.560.30F
Steel flange for with Ø35mm arbors - Male	992.560.35M	Steel flange for with Ø35mm arbors - Female	992.560.35F
Steel flange for with Ø40mm arbors - Male	992.560.40M	Steel flange for with Ø40mm arbors - Female	992.560.40F

Saw blades
Jig saw blades
Tools with bore & Knives
Router bits & sets
CNC router cutter & chucks
Industrial dowel drills
Bits for hand power tools
Power tools & accessories
Display cabinets & spare parts

Saw blade arbor with parallel shank

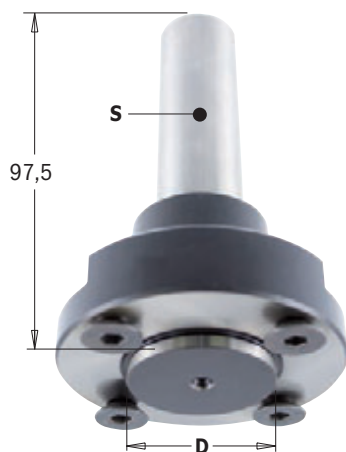

183.410

RH
LH

S mm	D mm	Pin Hole	L mm	ORDER NO.
20	30	4/M6/48	97,5	183.410.30

Spare parts

990.083.00	M6x10mm TCEI screw
991.067.00	3mm allen key
991.064.00	4mm allen key

Collet chucks clamp with MK2 tapered shank

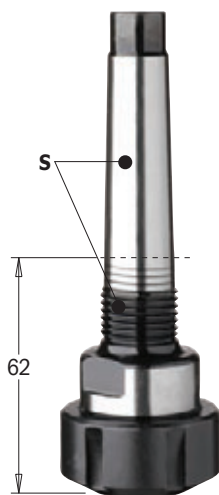

123

RH LH

S	ORDER NO. Right-hand rotation	ORDER NO. Left-hand rotation
MK2/Ø20x14Fx1"	123.000.01	123.000.02

Collets for 123 chucks

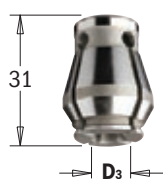

124

D ₃ mm	ORDER NO.	D ₃ mm	ORDER NO.
6	124.060.00	10	124.100.00
6,35	124.064.00	12	124.120.00
8	124.080.00	12,7	124.127.00
9,5	124.095.00	14	124.140.00

Clamping nuts



992.123

RH LH

DESCRIPTION	ORDER NO. Right-hand rotation	ORDER NO. Left-hand rotation
Clamping nut	992.123.01	992.123.02

C-spanner



991.123

DESCRIPTION	ORDER NO.
Type 40-42 "Usag" c-spanner	991.123.00

Sharp technology with a new twist

A special super-micrograin carbide formulation was created to produce and hold a keen cutting edge.

The new low-angle spiral is designed specifically to shear wood cleanly and provide efficient chip ejection.

The tools run cooler and the edges last longer.

Increased feed rate and improved cutting quality for enhanced productivity with CMT!

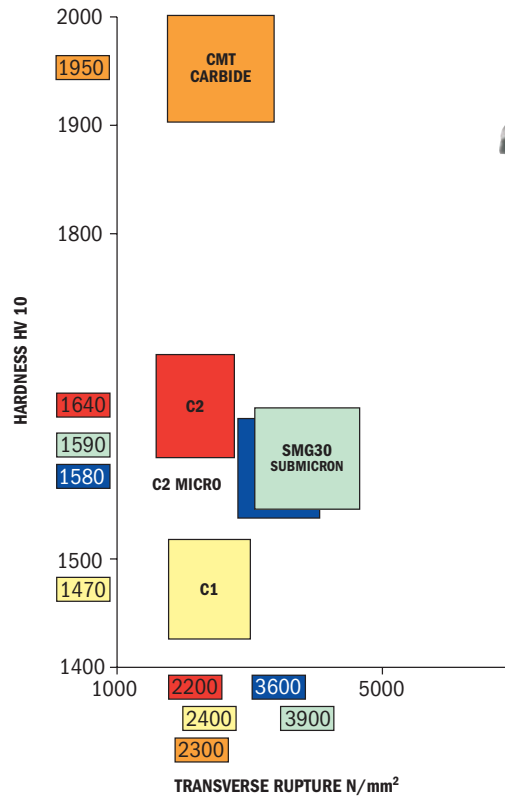

Solid carbide upcut spiral bits

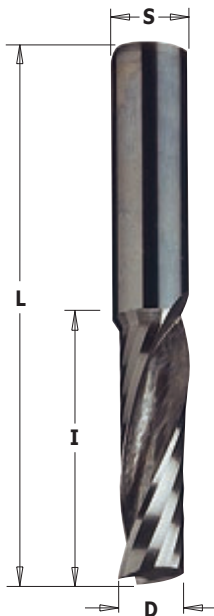

198

HWM Z1 RH

D mm	I mm	L mm	S mm	ORDER NO. Right-hand rotation
3	12	50	3	198.030.11
3,18	12,7	50,8	6,35	198.001.11
4	15	50	4	198.040.11
4,76	15,87	50,8	6,35	198.005.11
5	17	50	5	198.050.11
6	22	60	6	198.060.11
6,35	19,05	50,8	6,35	198.007.11
6,35	25,4	63,5	6,35	198.008.11
8	22	70	8	198.080.11
new 8	32	80	8	198.081.11
9,52	28,57	76,2	9,52	198.504.11
10	32	70	10	198.100.11
10	42	80	10	198.101.11
10	52	90	10	198.102.11
12	32	83	12	198.120.11

TECHNICAL DETAILS:

- Premium quality HWM.
- 1 spiral cutting edge [Z1].
- Provide an excellent finish on the lower side of the workpiece.
- **Upward chip ejection.**

APPLICATION: used for cutting, copying, panel sizing and any routing applications on solid wood, wood composites, plastic materials and laminates. Use a high feed speed on well-clamped workpieces. Can be used on machining centres, point to point machines, CNC routers and hand-held routers equipped with chucks or adaptors.

Saw blades
Jig saw blades
Tools with bore & Knives
Router bits & sets
CNC router cutter & chucks
Industrial dowel drills
Bits for hand power tools
Power tools & accessories
Display cabinets & spare parts

Solid carbide up & downcut spiral bits

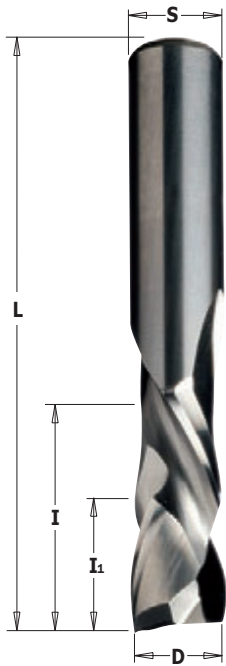

190

HWM Z2+2 Z3+3 RH

	D mm	I mm	I ₁ mm	L mm	S mm	Z	ORDER NO. Right-hand rotation
new	4	15	7	50	4	2+2	190.040.11
new	5	22	8	60	5	2+2	190.050.11
new	6	22	8	60	6	2+2	190.060.11
	8	32	7	80	8	2+2	190.080.11
	9,52	28,6	7	76,2	9,52	2+2	190.504.11
	10	32	7	80	10	2+2	190.100.11
new	10	42	7	90	10	2+2	190.101.11
	12	42	7	90	12	2+2	190.120.11
new	12	52	7	100	12	2+2	190.121.11
	12,7	25,4	16	76,2	12,7	2+2	190.505.11
	12,7	28,6	16	76,2	12,7	2+2	190.506.11
	12,7	34,9	16	88,9	12,7	2+2	190.507.11
	12,7	41,3	16	101,6	12,7	2+2	190.508.11
	16	55	24	110	16	2+2	190.160.11
	18	55	30	110	18	2+2	190.180.11
...up & downcut mortising bits							
	9,52	22,2	4,8	76,2	9,52	2+2	190.513.11
	9,52	25,4	5,2	76,2	9,52	3+3	190.813.11
	12	25	5,2	83	12	3+3	190.320.11
	12,7	22,2	5,2	76,2	12,7	2+2	190.515.11
	12,7	34,9	5,2	88,9	12,7	2+2	190.517.11

TECHNICAL DETAILS:

- Premium quality HWM.
- 2+2 spiral cutting edges [Z2+2].
- 3+3 spiral cutting edges [Z3+3].
- Provide an excellent finish on both the upper and the lower side of the workpiece.

APPLICATION: used for cutting, copying, panel sizing and any routing application on solid wood, wood composites, plastic materials and laminates. Use a high feed speed on well-clamped workpieces. Can be used on machining centres, point to point machines, CNC routers and hand-held routers equipped with chucks or adaptors.

Solid carbide upcut spiral bits

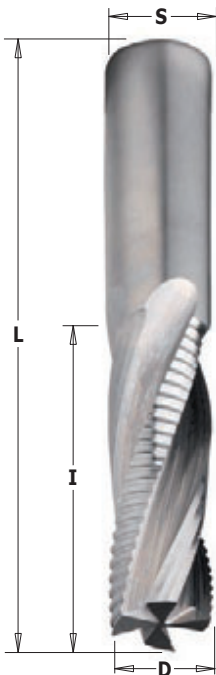

197

HWM Z4 RH

	D mm	I mm	L mm	S mm	ORDER NO. Right-hand rotation
	12	42	90	12	197.121.11
	14	50	110	14	197.140.11
	16	55	110	16	197.160.11
	16	35	90	16	197.161.11
	18	55	110	18	197.180.11
	20	60	120	20	197.200.11
	20	70	120	20	197.201.11

TECHNICAL DETAILS:

- Premium quality HWM.
- 4 spiral cutting edges (2 with chip-breaker) [Z2+2R].
- Max 0.1mm tooth depth.
- Provide excellent finish on the lower side of the workpiece.
- Upward chip ejection.

APPLICATION: used for ripping, template routing, panel sizing and any routing application on solid wood and wood composites. Can be used on machining centres, point to point machines, CNC routers and hand-held routers equipped with chucks or adaptors.



**The special 4 flute design
(Z2 finishing + Z2R with chipbreaker)
allows high speed with excellent finish on the workpiece.**

Solid carbide upcut spiral bits with chip-breaker

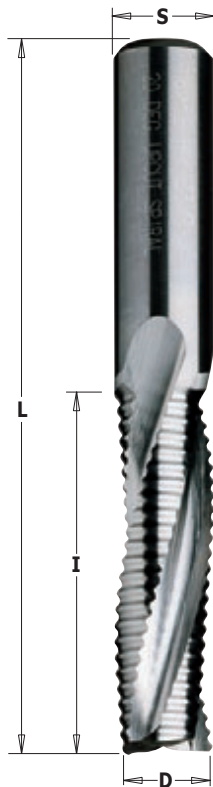
HWM **Z3R** **RH** **LH**

195

D mm	I mm	L mm	S mm	ORDER NO. Right-hand rotation	ORDER NO. Left-hand rotation
8	32	80	8	195.081.11	195.081.12
8	42	90	8	195.082.11	
10	32	80	10	195.100.11	195.100.12
10	42	90	10	195.101.11	
12	35	83	12	195.120.11	195.120.12
12	42	90	12	195.121.11	
12	52	100	12	195.122.11	
12,7	38,1	88,9	12,7	195.506.11	
14	58	110	14	195.140.11	
15,88	54	109,5	15,88	195.509.11	
16	55	110	16	195.160.11	195.160.12
16	35	90	16	195.161.11	
new 16	72	120	16	195.165.11	
18	55	110	18	195.180.11	
19,05	54	109,5	19,05	195.511.11	
20	60	120	20	195.200.11	195.200.12
20	72	120	20	195.201.11	
new 20	102	165	20	195.202.11	

TECHNICAL DETAILS:

- Premium quality HWM.
- 3 spiral cutting edges [Z3R].
- Chip breaker teeth.
- Max 0.3mm tooth depth.
- Provide an excellent finish on the lower side of the workpiece.
- Upward chip ejection.

APPLICATION: used for ripping, template routing, panel sizing and any routing application on solid wood, or wood composites. Can be used at a high feed speed on well-clamped workpieces. Can be used on machining centres, point to point machines, CNC routers and hand-held routers equipped with chucks or adaptors.

Solid carbide downcut spiral bits with chip-breaker

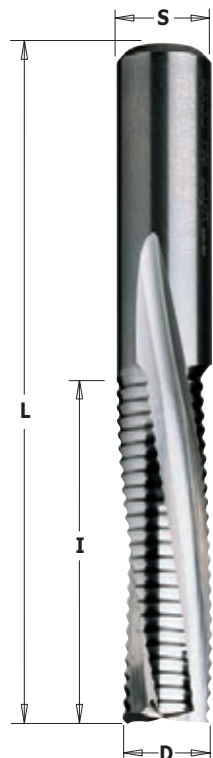
HWM **Z3R** **RH** **LH**

196

D mm	I mm	L mm	S mm	ORDER NO. Right-hand rotation	ORDER NO. Left-hand rotation
8	32	80	8	196.081.11	
10	42	90	10	196.101.11	
12	35	83	12	196.120.11	196.120.12
new 12	42	90	12	196.121.11	
new 12	52	100	12	196.122.11	
12,7	38,1	88,9	12,7	196.506.11	
14	50	110	14	196.140.11	
15,88	54	109,5	15,88	196.509.11	
16	55	110	16	196.160.11	196.160.12
18	55	110	18	196.180.11	
19,05	54	109,5	19,05	196.511.11	
20	60	120	20	196.200.11	196.200.12
new 20	72	120	20	196.201.11	

TECHNICAL DETAILS:

- Premium quality HWM.
- 3 spiral cutting edges [Z3R].
- Chip breaker teeth.
- Max 0.3mm tooth depth.
- Provide excellent finish on the upper side of the workpiece.
- Downward chip ejection.

APPLICATION: used for ripping, template routing, panel sizing and any routing application on solid wood and wood composites. Can be used on machining centres, point to point machines, CNC routers and hand-held routers equipped with chucks or adaptors.

Solid carbide upcut spiral bits

HWM Z3 RH LH

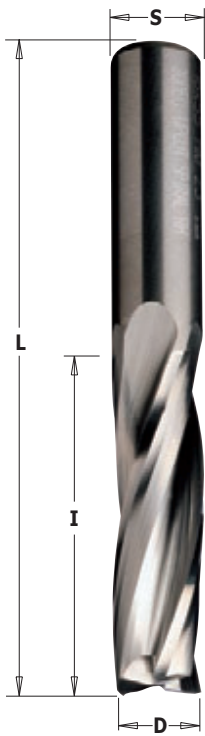

193

D mm	I mm	L mm	S mm	ORDER NO.	ORDER NO.
				Right-hand rotation	Left-hand rotation
8	32	80	8	193.081.11	193.081.12
10	32	80	10	193.100.11	193.100.12
10	42	90	10	193.101.11	
12	35	83	12	193.120.11	193.120.12
12	42	90	12	193.121.11	
NEW 12	52	100	12	193.122.11	
14	58	110	14	193.140.11	
16	55	110	16	193.160.11	193.160.12
16	35	90	16	193.161.11	
NEW 16	72	120	16	193.165.11	
18	55	110	18	193.180.11	
20	60	120	20	193.200.11	193.200.12
20	70	120	20	193.201.11	

TECHNICAL DETAILS:

- Premium quality HWM.
- 3 spiral cutting edges [Z3].
- Provide an excellent finish on the lower side of the workpiece.
- Upward chip ejection.

APPLICATION: used for ripping, template routing, panel sizing and any routing application on solid wood, or wood composites. Can be used at a high feed speed on well-clamped workpieces. Can be used on machining centres, point to point machines, CNC routers and hand-held routers equipped with chucks or adaptors.

Solid carbide spiral bits downcut

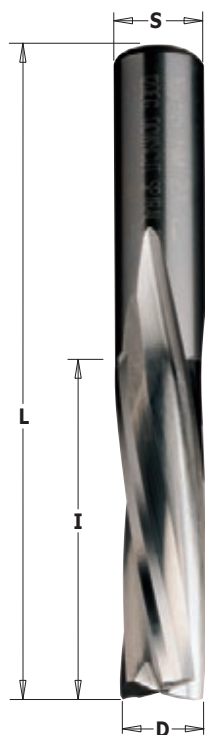

194

HWM Z3 RH LH

D mm	I mm	L mm	S mm	ORDER NO.	ORDER NO.
				Right-hand rotation	Left-hand rotation
10	32	80	10	194.100.11	
NEW 10	42	90	10	194.101.11	
12	35	83	12	194.120.11	194.120.12
NEW 12	42	90	12	194.121.11	
14	50	110	14	194.140.11	
16	55	110	16	194.160.11	194.160.12
16	35	90	16	194.161.11	
18	55	110	18	194.180.11	
20	60	120	20	194.200.11	194.200.12
NEW 20	72	120	20	194.201.11	
NEW 20	102	165	20	194.202.11	

TECHNICAL DETAILS:

- Premium quality HWM.
- 3 spiral cutting edges [Z3].
- Provide an excellent finish on the upper side of the workpiece.
- Downward chip ejection.

APPLICATION: used for ripping, template routing, panel sizing and any routing application on solid wood, wood composites, plastic materials and laminates. Can be used at a high feed speed on small, difficult to clamp workpieces. Can be used on machining centres, point to point machines, CNC routers and hand-held routers equipped with chucks or adaptors.

Solid carbide upcut spiral bits

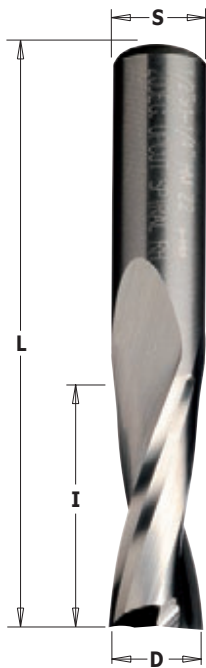
HWM **Z2** **RH**

191

D mm	I mm	L mm	S mm	ORDER NO. Right-hand rotation
3	12	50	3	191.030.11
3	12	60	6	191.630.11
3	12	60	8	191.830.11
3,18	12,7	50,8	6,35	191.001.11
3,5	12	60	6	191.635.11
3,97	12,7	50,8	6,35	191.003.11
4	15	50	4	191.040.11
4	15	60	6	191.640.11
4	15	60	8	191.840.11
4,76	19,05	50,8	6,35	191.005.11
5	17	50	5	191.050.11
5	17	60	6	191.650.11
5	17	60	8	191.850.11
6	27	70	6	191.060.11
6	27	70	8	191.860.11
6,35	19,05	50,8	6,35	191.007.11
6,35	25,4	63,5	6,35	191.008.11
7	32	80	8	191.870.11
7,94	25,4	76,2	12,7	191.501.11
8	22	70	8	191.080.11
8	32	80	8	191.081.11
8	42	90	8	191.082.11
9	32	83	12	191.890.11
9,52	31,75	76,2	12,7	191.503.11
10	32	80	8	191.800.11
10	32	80	10	191.100.11
10	32	83	12	191.900.11
10	42	90	10	191.101.11
10	42	90	12	191.901.11
12	35	83	8	191.820.11
12	35	83	12	191.120.11
12	42	90	12	191.121.11
12	52	100	12	191.122.11
12,7	31,75	76,2	12,7	191.505.11
12,7	38,1	88,9	12,7	191.506.11
12,7	50,8	101,6	12,7	191.507.11
14	50	110	14	191.140.11
15,88	55	109,5	15,88	191.509.11
16	55	110	16	191.160.11
16	35	90	16	191.161.11
new 16	72	120	16	191.165.11
19,05	55	109,5	19,05	191.511.11
20	60	120	20	191.200.11

TECHNICAL DETAILS:

- Premium quality HWM.
- 2 spiral cutting edges [Z2].
- Provide an excellent finish on the lower side of the workpiece.
- Upward chip ejection.

APPLICATION: used for ripping, template routing, panel sizing and any routing application on solid wood, wood composites, plastic materials and laminates.

Can be used at a high feed speed on well-clamped workpieces.

Can be used on machining centres, point to point machines, CNC routers and hand-held routers equipped with chucks or adaptors.

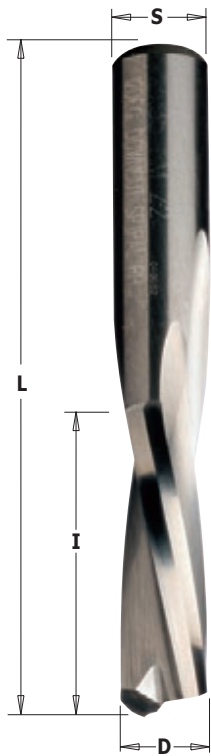

192

D mm	I mm	L mm	S mm	ORDER NO. Right-hand rotation
3	12	50	3	192.030.11
3	12	60	6	192.630.11
3	12	60	8	192.830.11
3,18	12,7	50,8	6,35	192.001.11
3,97	12,7	50,8	6,35	192.003.11
4	15	50	4	192.040.11
4	15	60	6	192.640.11
4	15	60	8	192.840.11
4,76	19,05	50,8	6,35	192.005.11
5	17	50	5	192.050.11
5	17	60	6	192.650.11
5	17	60	8	192.850.11
6	27	70	6	192.060.11
6	27	70	8	192.860.11
6,35	19,05	50,8	6,35	192.007.11
6,35	25,4	63,5	6,35	192.008.11
7,94	25,4	76,2	12,7	192.501.11
8	22	70	8	192.080.11
8	32	80	8	192.081.11
8	42	90	8	192.082.11
9,52	31,75	76,2	12,7	192.503.11
10	32	80	8	192.800.11
10	32	80	10	192.100.11
<small>new</small> 10	42	90	10	192.101.11
10	32	83	12	192.900.11
12	35	83	8	192.820.11
12	35	83	12	192.120.11
12,7	31,75	76,2	12,7	192.505.11
12,7	38,1	88,9	12,7	192.506.11
12,7	50,8	101,6	12,7	192.507.11
<small>new</small> 14	52	110	14	192.140.11
16	55	110	16	192.160.11

TECHNICAL DETAILS:

- Premium quality HWM.
- 2 spiral edges [Z2].
- Provide an excellent finish on the upper side of the workpiece.
- Downward chip ejection.

APPLICATION: used for ripping, template routing, panel sizing and any routing application on solid wood, wood composites, plastic materials and laminates.

Can be used at a high feed speed on small, difficult to clamp work pieces.

Can be used on machining centres, point to point machines, CNC routers and hand-held routers equipped with chucks or adaptors.

Solid carbide upcut spiral bits for locksets

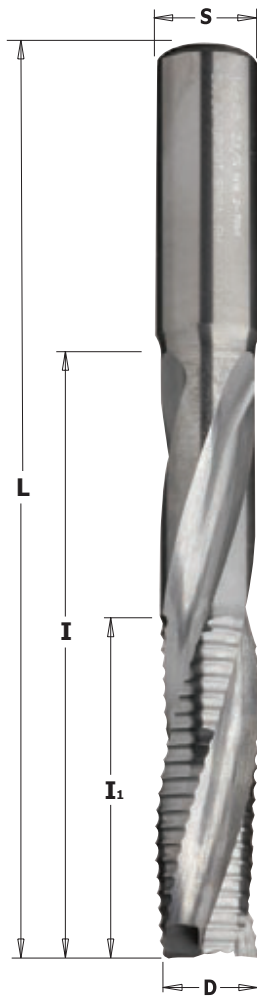

195

HWM **Z3R** **Z3** **RH**

D mm	I mm	I ₁ mm	L mm	S mm	ORDER NO. Right-hand rotation
<i>with chip-breaker</i>					
14	95*	45	150	14	195.142.11
new 14	125*	45	170	14	195.144.11
16	95*	45	150	16	195.162.11
new 16	120*	50	170	16	195.164.11
18	95*	45	150	18	195.182.11
<i>without chip-breaker</i>					
new 16	95*	45	150	16	193.162.11

* The maximum cutting length is achieved in 2-3 passes.

TECHNICAL DETAILS:

- Premium quality HWM.
- 3 spiral cutting edges [Z3] and [Z3R].
- Max 0.3mm tooth depth.
- Provide an excellent finish on the lower side of the workpiece.
- Upward chip ejection.

APPLICATION: used for ripping, template routing, panel sizing and any routing application on solid wood, or wood composites. Can be used at a high feed speed on well-clamped workpieces. Can be used on machining centres, point to point machines, CNC routers and hand-held routers equipped with chucks or adaptors.

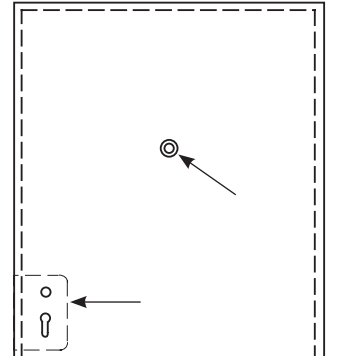

Solid carbide upcut with spiral bits chip-breaker for 60° V-point locksets

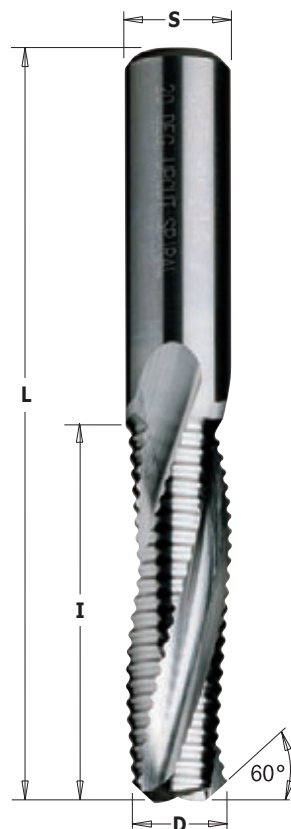

195.143/163

HWM **Z3R** **RH**

D mm	I mm	L mm	S mm	ORDER NO. Right-hand rotation
14	58	110	14	195.143.11
16	55	110	16	195.163.11

Solid carbide upcut spiral bits without chip-breaker for 60° V-point locksets

191.143/163

HWM **Z3** **RH**

D mm	I mm	L mm	S mm	ORDER NO. Right-hand rotation
14	50	110	14	191.143.11
16	55	110	16	191.163.11

TECHNICAL DETAILS:

- Premium quality HWM.
- 3 spiral cutting edges [Z3].
- Provide an excellent finish on the lower side of the workpiece.
- Upward chip ejection.

APPLICATION: used for ripping, template routing, panel sizing and any routing application on solid wood, or wood composites. Can be used at a high feed speed on well-clamped workpieces. Can be used on machining centres, point to point machines, CNC routers and hand-held routers equipped with chucks or adaptors.

Spiral bits with insert knives and chip-breaker for locksets

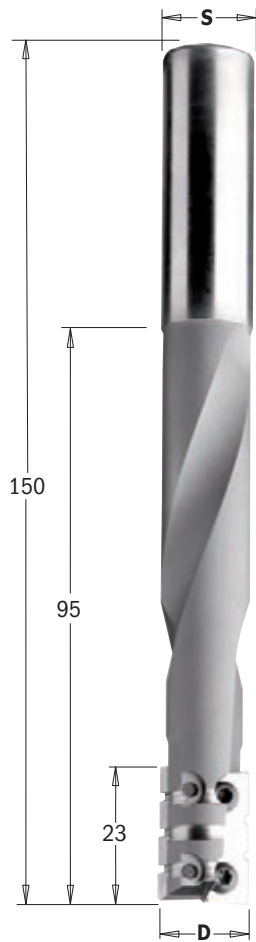

662

INSERT CARBIDE Z2R RH

D mm	I mm	L mm	S mm	ORDER NO. Right-hand rotation
16	23/95*	150	16	662.160.11

Spare parts
 790.230.2R 23x7x1.5mm 2-RT HWM knives
 790.230.3R 23x7x1.5mm 3-RT HWM knives
 990.082.00 M3x4mm T9 Torx screw
 991.069.00 T9 Torx key

* The 95mm length is achieved in 3-4 passes.

TECHNICAL DETAILS:
 - Densimet® tungsten heavy metal alloys for low-vibration.
 - 2 cutting edges [Z2R].
 - Chip-breaker teeth.

APPLICATION: used for ripping, template routing, panel sizing and any routing application on solid wood, or wood composites. Can be used at a high feed speed on well-clamped workpieces. Can be used on machining centres, point to point machines, CNC routers and hand-held routers equipped with chucks or adaptors.

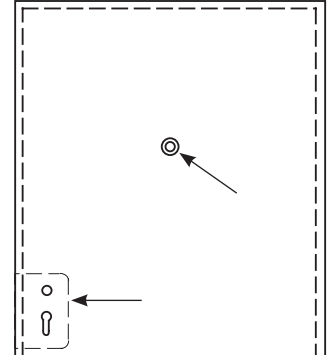

Upcut spiral bits with chipbreaker for glue-laminated wooden beams

new

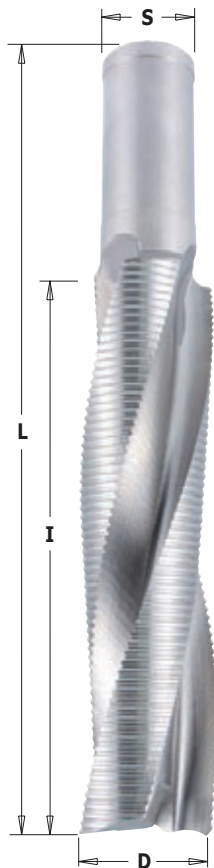

195

HS Z3R RH

D mm	I mm	L mm	S mm	ORDER NO. Right-hand rotation
□ 30	170	235	30	Y195.300.51
40	165	235	30	195.400.51
50	215	295	30	195.500.51

TECHNICAL DETAILS:
 - High speed cobalt steel.
 - 3 upcut spiral cutting edges with chipbreaker [Z3R].
 - Upward chip ejection.
 - Resharpenable cutters (max 6000~10000 times).
 - Maximum feed speed 2m/minute.

APPLICATION: Used for cutting, copying, and routing on glue-laminated wooden beams. To be inserted on Hundegger machines.

□ **On request**
 We manufacture bits without chipbreaker, with left-hand rotation and also in custom dimensions.

Round nose solid carbide upcut spiral bits

HWM Z2 RH

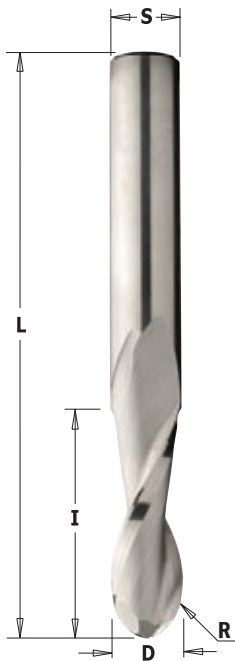

199

D mm	R mm	I mm	L mm	S mm	ORDER NO. Right-hand rotation
3,18	1,6	12,7	50,8	6,35	199.001.11
6	3	27	70	6	199.060.11
6,35	3,18	25,4	63,5	6,35	199.008.11
8	4	32	80	8	199.081.11
9,52	4,76	28,57	76,2	9,52	199.504.11
10	5	32	80	10	199.100.11
12	6	35	80	12	199.120.11
12,7	6,35	31,75	76,2	12,7	199.505.11
15,88	7,94	57,15	109,5	15,88	199.509.11
16	8	55	110	16	199.160.11
19,05	9,52	57,15	109,5	19,05	199.511.11

TECHNICAL DETAILS:

- Premium quality HWM.
- 2 upcut spiral cutting edges [Z2].
- Excellent finish on the lower side of the work piece.
- Upward chip ejection.

APPLICATION: used for ripping, template routing, panel sizing and any routing application on solid wood, wood composites, plastic materials and laminates. Can be used at a high feed speed on well-clamped workpieces. For use on machining centers, point-to point machines, CNC routers and hand-held routers equipped with chucks or adaptors.

DP router cutters with shear angle



141

DP Z1+1 Z1 RH

D mm	I mm	L mm	S mm	Z	ORDER NO. Right-hand rotation
6	8	65	12x40	1	141.060.61
8	12	65	12x40	1	141.080.61
*10	22	75	12x40	1+1	141.101.61

TECHNICAL DETAILS:

- Super strength steel.
- DP cutting edge.
- HW plunging tip for diagonal plunge-cutting.
- Resharpenable cutter (max 3 times).
- Max feed speed 4 m/min.

40X
LONGER LIFE
THAN CARBIDE

APPLICATION: to be used on all CNC routers for jointing and sizing of solid wood and wood-based panels.

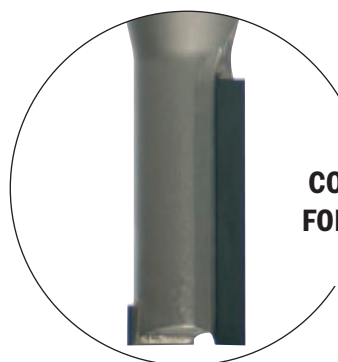

*** Z1+1
CONSTRUCTION
FOR 141.101.61
ITEM**

DP router cutters with shear angle



140

DP Z1+1 RH

new

D mm	I mm	L mm	S mm	Z	ORDER NO. Right-hand rotation
10	22	75	12x40	1+1 (3 DP+1 HW)	140.03956
12	27	75	12x40	1+1 (3 DP+1 HW)	140.120.61
12	35	84	12x40	1+1 (4 DP+1 HW)	140.121.61
12,7	27	75	12,7x40	1+1 (3 DP+1 HW)	140.127.61
12,7	35	84	12,7x40	1+1 (4 DP+1 HW)	140.128.61
15,87	27	87	15,87x50	1+1 (3 DP+1 HW)	140.158.61
15,87	44	103	15,87x50	1+1 (5 DP+1 HW)	140.159.61
16	27	87	16x50	1+1 (3 DP+1 HW)	140.160.61
16	35	95	16x50	1+1 (4 DP+1 HW)	140.161.61
18	27	87	20x50	1+1 (3 DP+1 HW)	140.180.61
18	35	95	20x50	1+1 (4 DP+1 HW)	140.181.61
18	44	103	20x50	1+1 (5 DP+1 HW)	140.182.61
19,05	27	87	19,05x50	1+1 (3 DP+1 HW)	140.190.61
19,05	44	103	19,05x50	1+1 (5 DP+1 HW)	140.192.61
20	27	87	20x50	1+1 (3 DP+1 HW)	140.200.61
20	35	95	20x50	1+1 (4 DP+1 HW)	140.201.61
20	44	103	20x50	1+1 (5 DP+1 HW)	140.202.61
20	53	112	20x50	1+1 (6 DP+1 HW)	140.203.61

TECHNICAL DETAILS:

- Super strength steel.
- DP cutting edge.
- HW plunging tip for diagonal plunge-cutting (Z-axis tool entrance).
- Resharpenable cutter (max 3 times).
- Max feed speed 5 m/min.



APPLICATION: to be used on all CNC routers for jointing, rabbeting, grooving and copying of raw material, melamine and laminates, MDF, HPL and veneered panels.

Diamond router cutters with 45° shear angle

new

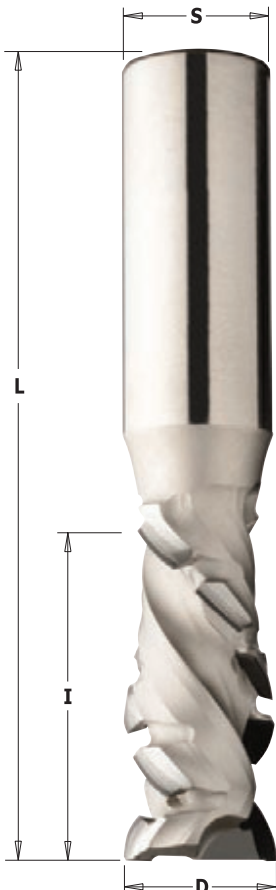

140

DP Z1+1 RH

D mm	I mm	L mm	S mm	Z	ORDER NO. Right-hand rotation
20	25	85	20x50	1+1 (6 DP+1 HW)	140.720.61
20	35	95	20x50	1+1 (8 DP+1 HW)	140.721.61
20	45	105	20x50	1+1 (10 DP+1 HW)	140.722.61

TECHNICAL DETAILS:

- Super strength steel.
- "H4" diamond cutting edges featuring 45° shear angle.
- HW plunging tip for plunge cutting.
- Resharpenable cutters (max 8-9 times).
- Maximum feed speed 5m/minute.



APPLICATION: to be used on all CNC routers for jointing, rabbeting, grooving and copying of raw material, melamine and laminates, MDF, HPL and veneered panels.

DP router cutters with shear angle

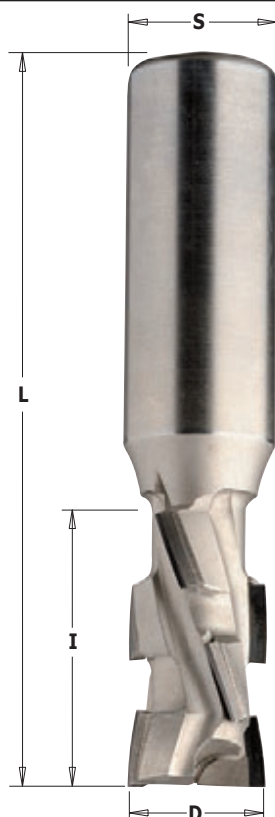
**142****DP Z2+2 RH**

D mm	I mm	L mm	S mm	Z	ORDER NO. Right-hand rotation
20	27	85	20x50	2+2 (6 DP+1 HW)	142.200.61
20	36	95	20x50	2+2 (8 DP+1 HW)	142.201.61
20	45	105	20x50	2+2 (10 DP+1 HW)	142.202.61
20	54	115	20x50	2+2 (12 DP+1 HW)	142.203.61
new 25	27	85	25x50	2+2 (6 DP+1 HW)	142.250.61
new 25	36	95	25x50	2+2 (8 DP+1 HW)	142.251.61
new 25	45	105	25x50	2+2 (10 DP+1 HW)	142.252.61
new 25	54	115	25x50	2+2 (12 DP+1 HW)	142.253.61

TECHNICAL DETAILS:

- Super strength steel.
- DP cutting edge.
- HW plunging tip for diagonal plunge-cutting (Z-axis tool entrance).
- Resharpenable cutter (max 3 times).
- Max feed speed 10 m/min.

APPLICATION: to be used on all CNC routers for jointing, rabbeting, grooving, copying and dividing cuts of raw material, melamine and laminates, MDF, HPL and veneered panels.

40X
LONGER LIFE
THAN CARBIDE

Diamond router cutters with 20° shear angle

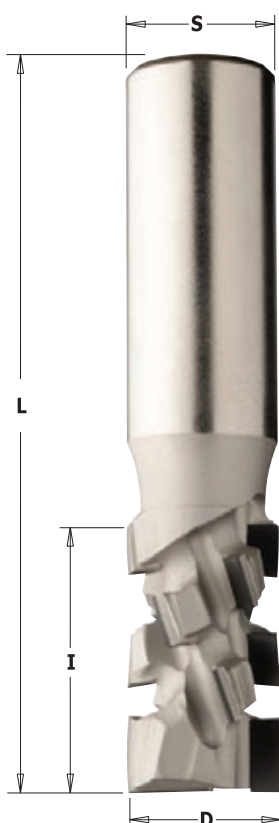
**new****142****DP Z2+2 RH**

D mm	I mm	L mm	S mm	Z	ORDER NO. Right-hand rotation
20	25	85	20x45	2+2 (8 DP+1 HW)	142.720.61
20	30	90	20x45	2+2 (10 DP+1 HW)	142.721.61
20	35	95	20x45	2+2 (12 DP+1 HW)	142.722.61
20	40	100	20x45	2+2 (14 DP+1 HW)	142.723.61
20	45	105	20x45	2+2 (16 DP+1 HW)	142.724.61
20	50	110	20x45	2+2 (18 DP+1 HW)	142.725.61
20	55	115	20x45	2+2 (20 DP+1 HW)	142.726.61

TECHNICAL DETAILS:

- Super strength steel.
- "H4" diamond cutting edges featuring 20° shear angle.
- HW plunging tip for diagonal plunge-cutting (Z-axis tool entrance).
- Resharpenable cutters (max 8-10 times).
- Maximum feed speed 20m/minute.

APPLICATION: used on all CNC routers for jointing, rabbeting, grooving, copying and dividing raw material, melamine, laminated, MDF, HPL and veneered panels.

40X
LONGER LIFE
THAN CARBIDE

DP spiral router cutters with shear angle

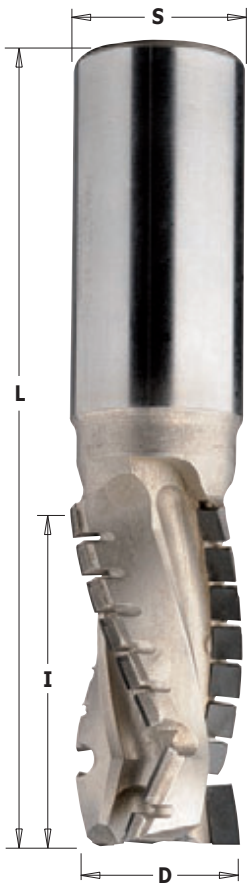

143

DP Z3 RH

D mm	I mm	L mm	S mm	Z	ORDER NO. Right-hand rotation
22	30	90	25x50	3 (12 DP+1 HW)	143.220.61
□ 22	35	95	25x50	3 (15 DP+1 HW)	143.221.61
22	40	100	25x50	3 (18 DP+1 HW)	143.222.61
□ 22	45	105	25x50	3 (20 DP+1 HW)	143.223.61
22	50	110	25x50	3 (21 DP+1 HW)	143.224.61
□ 22	55	115	25x50	3 (24 DP+1 HW)	143.225.61
22	60	120	25x50	3 (27 DP+1 HW)	143.226.61
□ 22	65	125	25x50	3 (29 DP+1 HW)	143.227.61
□ 22	70	130	25x50	3 (30 DP+1 HW)	143.228.61

□ On request

TECHNICAL DETAILS:

- Super strength steel. - DP cutting edge.
- HW plunging tip for diagonal plunge-cutting (Z-axis tool entrance).
- Resharpenable cutter (max 6 times). - Max feed speed 25 m/min.

40X
LONGER LIFE
THAN CARBIDE

DP router cutters with shear angle for Nesting (Densimet® tungsten heavy metal alloys)

D mm	I mm	L mm	S mm	Z	ORDER NO. Right-hand rotation
new 12	25	70	12x40	3 (9 DP)	143.120.61
new 12	31	80	12x40	3 (12 DP)	143.121.61

TECHNICAL DETAILS:

- Densimet® tungsten heavy metal alloys for low-vibration. - DP cutting edge.
- Resharpenable cutter (max 6 times).
- Max feed speed 25 m/min.

40X
LONGER LIFE
THAN CARBIDE

APPLICATION: to be used on all CNC routers for jointing, rabbeting, grooving, copying and dividing cuts of raw material, melamine and laminates, MDF, HPL and veneered panels. High performance on pre-and finish-routing.

Diamond router cutters with 40° shear angle for roughing



new



145

DP Z3 Z4 RH

D mm	I mm	L mm	S mm	Z	ORDER NO. Right-hand rotation
□ 50	23	80	25x55	3+3 (9 DP)	145.501.61
□ 50	23	80	25x55	4+4 (12 DP)	145.511.61
□ 50	28	85	25x55	3+3 (15 DP)	145.502.61
□ 50	28	85	25x55	4+4 (20 DP)	145.512.61
□ 50	38	95	25x55	3+3 (21 DP)	145.503.61
□ 50	38	95	25x55	4+4 (28 DP)	145.513.61

TECHNICAL DETAILS:

- Super strength steel.
- "H4" diamond cutting edges featuring 40° shear angle.
- Resharpenable cutters (max 8-10 times).
- Maximum feed speed 30m/minute.

40X
LONGER LIFE
THAN CARBIDE

APPLICATION: used on all CNC routers for jointing, rabbeting, grooving, copying and dividing raw material, melamine, laminated, MDF, HPL and veneered panels. High performance routing.

□ On request

Solid carbide router cutters

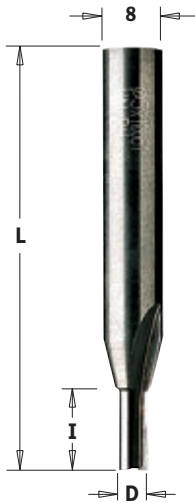
174

D	I	L	S	ORDER NO.
mm	mm	mm	mm	Right-hand rotation
3	10	55	8	174.030.11
4	10	55	8	174.040.11
5	12	55	8	174.050.11
6	14	55	8	174.060.11
7	20	55	8	174.070.11

TECHNICAL DETAILS:

- Premium quality HWM.
- 2 radial relief cutting edges [Z2].

Router cutters

174



D	I	L	S	ORDER NO.
mm	mm	mm	mm	Right-hand rotation
8	20	55	8	174.080.11
8	30	70	8	174.081.11
8	40	90	8	174.082.11
9	20	55	8	174.090.11
10	20	60	8	174.100.11
10	30	70	8	174.102.11
10	40	90	8	174.101.11
11	20	60	8	174.110.11
12	20	60	8	174.120.11
12	30	70	8	174.122.11
12	40	90	8	174.121.11
13	20	60	8	174.130.11
14	20	60	8	174.140.11
14	30	70	8	174.142.11
14	40	90	8	174.141.11
15	20	60	8	174.150.11
16	20	70	8	174.160.11
16	30	70	8	174.162.11
16	40	90	8	174.161.11
18	20	70	8	174.180.11
18	30	70	8	174.181.11
18	40	80	8	174.182.11
19	20	70	8	174.190.11
20	20	70	8	174.200.11
20	30	70	8	174.201.11
20	40	90	8	174.202.11
22	20	70	8	174.220.11
22	30	70	8	174.221.11
22	40	90	8	174.222.11
24	20	70	8	174.240.11
24	30	70	8	174.241.11
24	40	90	8	174.242.11
25	20	70	8	174.250.11
26	20	70	8	174.260.11
26	30	70	8	174.261.11
28	20	70	8	174.280.11
28	30	70	8	174.281.11
29	20	70	8	174.290.11
30	20	70	8	174.300.11

HW plunge centre tip

TECHNICAL DETAILS:

- Super strength steel.
- 2 precision ground HW cutting edges and 1 HW plunge centre tip [Z2+1].

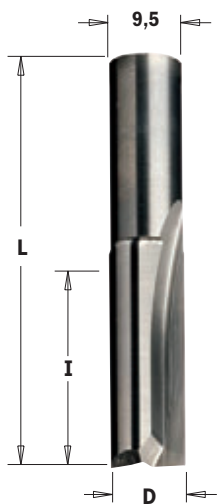
APPLICATION: used for drilling, grooving or jointing on solid wood and wood composites. Can be used on machining centres, CNC routers and hand-held routers equipped with chucks or adaptors.



112



D	I	L	S	ORDER NO.
mm	mm	mm	mm	Right-hand rotation
3	10	37	9,5	112.030.11
4	10	37	9,5	112.040.11
5	12	39	9,5	112.050.11
6	14	41	9,5	112.060.11
7	16	43	9,5	112.070.11
8	18	48	9,5	112.080.11
8	30	60	9,5	112.081.11
9	20	52	9,5	112.090.11
10*	22	52	9,5	112.100.11
10*	35	65	9,5	112.101.11
11*	26	52	9,5	112.110.11
12*	26	52	9,5	112.120.11

* Super strength steel
2 precision ground HW cutting edges [Z2+1]

TECHNICAL DETAILS:
- Premium quality HWM.
- 2 radial relief cutting edges [Z2+1].



Router cutters



113



D	I	L	S	ORDER NO.
mm	mm	mm	mm	Right-hand rotation
12	26	52	12	113.120.11
12	40	70	12	113.121.11
13	26	52	12	113.130.11
14	28	56	12	113.140.11
14	40	72	12	113.141.11
15	32	60	12	113.150.11
16	32	60	12	113.160.11
16	40	72	12	113.161.11
17	35	64	12	113.170.11
18	35	64	12	113.180.11
19	38	68	12	113.190.11
20	38	68	12	113.200.11
22	40	72	12	113.220.11
24	40	72	12	113.240.11
25	40	72	12	113.250.11
26	42	74	12	113.260.11
28	42	74	12	113.280.11
30	42	74	12	113.300.11

TECHNICAL DETAILS:
- Super strength steel.
- 2 precision ground HW cutting edges and 1 HW plunge centre tip [Z2+1].

APPLICATION: used for grooving, jointing and routing on solid wood, wood composites, plastic materials and laminates.

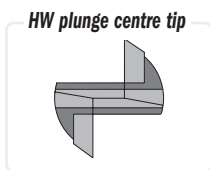

Router cutters



HW plunge centre tip



TECHNICAL DETAILS:

- Premium quality HWM.
- 2 radial relief cutting edges [Z2].
- 1 HW [Z1] plunge centre tip.

APPLICATION: for grooving, jointing and routing on solid wood, wood composites, plastic materials and laminates.

175



D mm	I mm	L mm	S mm	ORDER NO. Right-hand rotation
• 4	10	65	10	175.040.11
• 5	12	65	10	175.050.11
• 6	14	65	10	175.060.11
• 7	17	65	10	175.070.11
8	20	65	10	175.080.11
10	25	70	10	175.100.11
12	25	70	10	175.120.11
14	25	70	10	175.140.11
15	25	70	10	175.150.11
16	25	70	10	175.160.11
18	25	70	10	175.180.11
20	25	70	10	175.200.11
22	25	70	10	175.220.11
24	25	70	10	175.240.11
25	25	70	10	175.250.11
26	25	70	10	175.260.11
30	25	70	10	175.300.11
35	25	70	10	175.350.11

• HWM

176



D mm	I mm	L mm	S mm	ORDER NO. Right-hand rotation
10	40	87	10	176.100.11
12	40	87	10	176.120.11
14	40	87	10	176.140.11
15	40	87	10	176.150.11
16	40	87	10	176.160.11
18	40	87	10	176.180.11
20	40	87	10	176.200.11

177



D mm	I mm	L mm	S mm	ORDER NO. Right-hand rotation
10	35	90	12	177.100.11
12	35	90	12	177.120.11
12	50	100	12	177.121.11
14	35	90	12	177.140.11
16	35	90	12	177.160.11
16	60	110	12	177.161.11
18	35	90	12	177.180.11
18	60	110	12	177.181.11
20	35	90	12	177.200.11
22	35	90	12	177.220.11
24	35	90	12	177.240.11
25	35	90	12	177.250.11
26	35	90	12	177.260.11
28	35	90	12	177.280.11
30	35	90	12	177.300.11
35	35	90	12	177.350.11

TECHNICAL DETAILS:

- Super strength steel.
- 2 precision ground HW cutting edges and 1 HW plunge centre tip [Z2+1].

APPLICATION: used for grooving, jointing and general routing operation on solid wood, wood composites, plastics and laminates. Can be used on machining centres, CNC routers and hand-held routers.

HW plunge centre tip

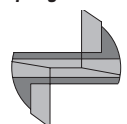

Saw blades
Jig saw blades
Tools with bore & Knives
Router bits & sets
CNC router cutter & chucks
Industrial dowel drills
Bits for hand power tools
Power tools & accessories
Display cabinets & spare parts

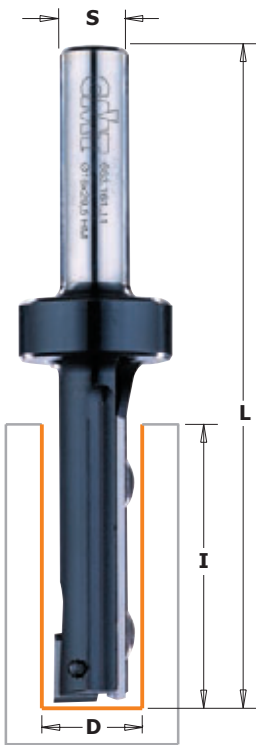

653

D mm	I mm	L mm	S mm	Spare knives		ORDER NO. Right-hand rotation
				side	top	
16	28,3	91,5	20	790.283.12	790.075.00	653.661.11
16	48,3	111,5	20	790.483.12	790.075.00	653.662.11
18	48,3	111,5	20	790.483.12	790.075.00	653.681.11
20	48,3	111,5	20	790.483.12	790.096.00	653.701.11

Spare parts

790.075.00	7,5x12x1,5mm knife
790.096.00	9,6x12x1,5mm knife
790.283.12	28,3x12x1,5mm knife
790.483.12	48,3x12x1,5mm knife
990.072.00	M3,5x3,5mm Torx screw
990.074.00	M4x3,5mm Torx screw
990.075.00	M4x6mm Torx screw
991.061.00	T15 Torx key

TECHNICAL DETAILS:

- Super strength steel.
- 2 cutting edges [Z1+1].

APPLICATION: straight router bit with one replaceable plunging knife and one side knife fixed by special Torx screws. The body is precise balanced. For finishing and routing, plunge cutting and grooving in boards materials (laminated chipboards, MDF) and hardwood. For use on CNC machining centres.

Spoilboard surfacing router cutters with insert knives



663.001.11

D mm	I mm	L mm	S mm	ORDER NO.	
				Right-hand rotation	
<small>new</small> 60	12	80	12	663.002.11	
80	12	90	20	663.001.11	

Spare parts

790.120.00	12x12x1,5mm knife
990.075.00	M4x6mm Torx T15 screw
991.061.00	T15 Torx key
790.140.00	14x14x2mm knife
990.083.00	M6x10mm TCEI screw
991.067.00	3mm allen key

TECHNICAL DETAILS:

- Super strength steel.
- 2 cutting edges [Z2].
- 2 scores knives [V2].

APPLICATION: new router bit for CNC router ideal for fast removal of material over a large surface area leaving an improved finish at the bottom of the cut. Used on soft and hardwood, particle board and MDF. The cutter uses 4-sided inserts.

Cost effective solution compared to brazed router bits and solid carbide spiral bits.

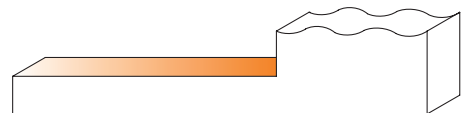
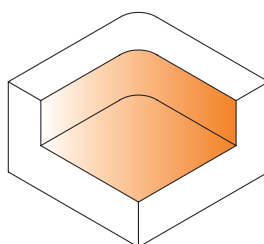

Drawings are 1:2 scale

Adjustable chamfering CNC cutter



663.201.11

D mm	D_Max 45° mm	I mm	A	L mm	S mm	ORDER NO. Right-hand rotation
85	102	39,5	0°-45° - 0°+90°	92	20	663.201.11

Spare parts

790.395.12	39x12x1,5mm knife
663.999.01	38x6x12mm wedge
990.087.00	M6x8mm STEI screw (4x2mm threaded pin)
991.067.00	3mm hex key
663.999.02	Kit with 2 wedges and 1 screw for blocking rotation
990.099.00	M8x25mm TCEI screw
990.023.00	M8 (4mm) nut
991.081.00	4mm "T" hex key

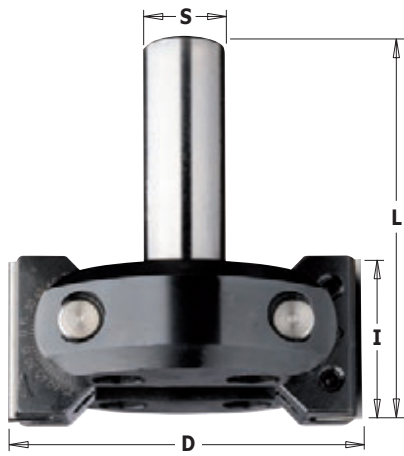

TECHNICAL DETAILS: tool body in steel, two TC reversible knives in swiveling blade carriers. Cutting on periphery and both sides. Swiveling range towards top 0-45°, toward bottom 0-90°, infinitely variable adjustment according to precise scale. With positive stops at 7,5° through adjustment aide. No displacement of adjusted beveling angle when replacing blades. Right rotation.

APPLICATION: for jointing, rebating and chamfering of solid wood and wooden boards. Suitable for CNC router machines and stationary router machine with manual or mechanical feed.

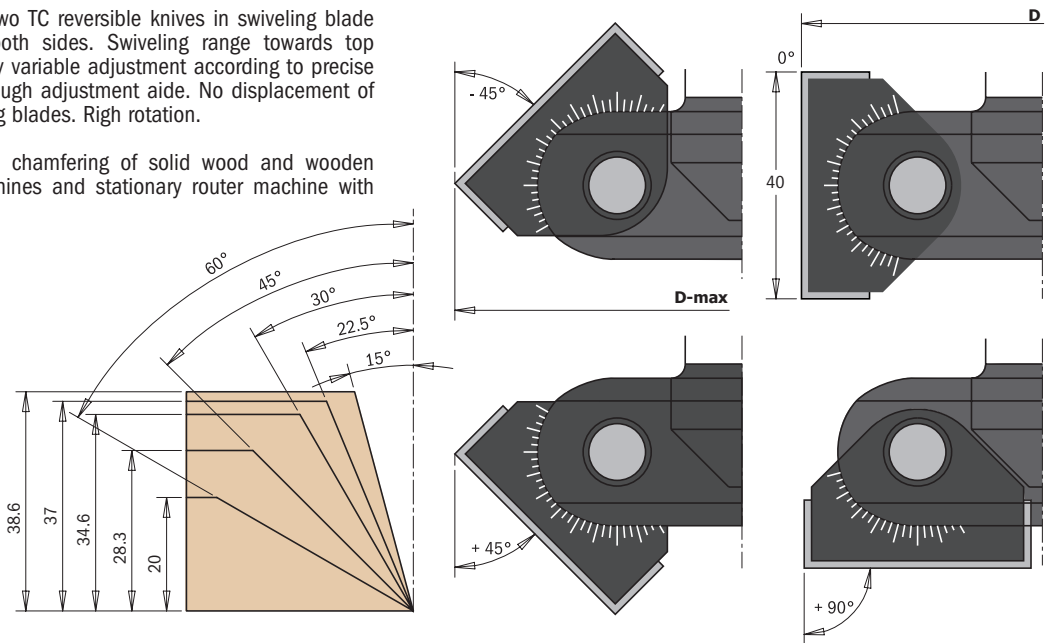

V-groove - folding - signmaking CNC router cutters with insert knives



663.101.11

D mm	I mm	L mm	S mm	ORDER NO. Right-hand rotation
52	25	100	20	663.101.11

Spare parts

790.360.01	36x12x1,5mm knife
990.077.00	M3,5x7mm Torx screw
991.061.00	T15 Torx key

Optional

S790.360.03	36x12x1,5mm HW-SMG replaceable knife (4 cutting edges 35°)
-------------	--

TECHNICAL DETAILS:
 - Super Strength steel.
 - 1 cutting edges [Z1].

APPLICATION: This innovative CNC router bit offers you an endless range of possibilities for V-Groove, miter folds, signmaking, lettering and chamfer edges. The tool mounts a high grade HWM reversible knife ideal for general purpose, chipboard and plywood, but a higher quality is available for laminated and MDF material.

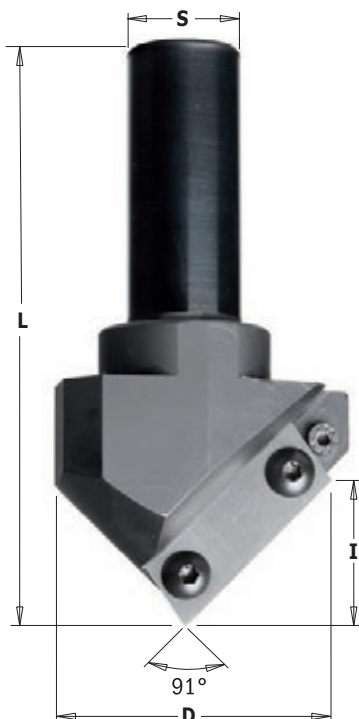
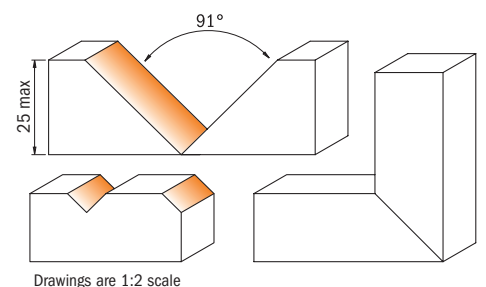

Saw blades
Jig saw blades
Tools with bore & Knives
Router bits & sets
CNC router cutter & chucks
Industrial dowel drills
Bits for hand power tools
Power tools & accessories
Display cabinets & spare parts



616.000.01

This unique system includes a tool body with 22 profile knives designed for multiple applications on your CNC routers. Ideal for MDF, laminates, veneers, plastic, wood and solid surface materials.



TECHNICAL DETAILS:

- Knives 20x20x2mm.
- We recommend to re-sharpen the knives on the profiled cutting edges.

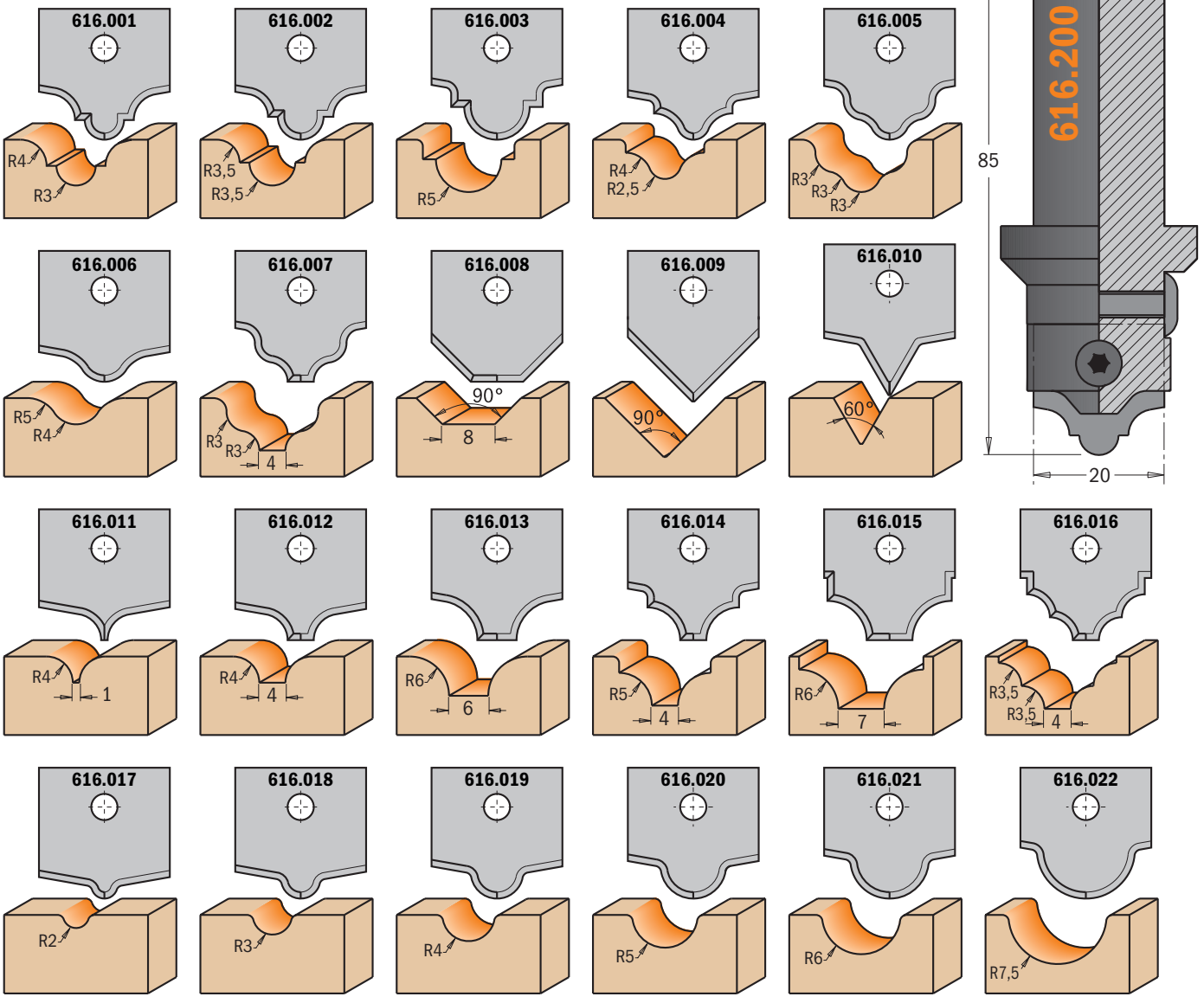

Drawings are 1:1 scale

DESCRIPTION	S mm	ORDER NO. Right-hand rotation	Spare parts		
Complete set for decorating and engraving	20	616.000.01	616.200	990.077.00	991.061.00

REMARK: tool body and insert knives can be sold individually.

Complete set for MDF doors



615.004.01

Open some new doors with CMT. Our 4-piece set includes the most popular profile to make MDF panel doors for kitchens and bathrooms. Each bit is made from bar stock steel and is equipped with 5 different profile knives allowing enormous possibilities for easy and economical construction. The highest materials, the lowest tolerance in balancing and the precision in the sharpening of the knives let you obtain a smooth finish on your CNC machine.

- Spare parts**
- 991.061.00 T15 Torx key
 - 990.073.00 M3,5x5mm Torx screw
 - 990.075.00 M4x6mm Torx screw
 - 990.077.00 M3,5x7mm Torx screw

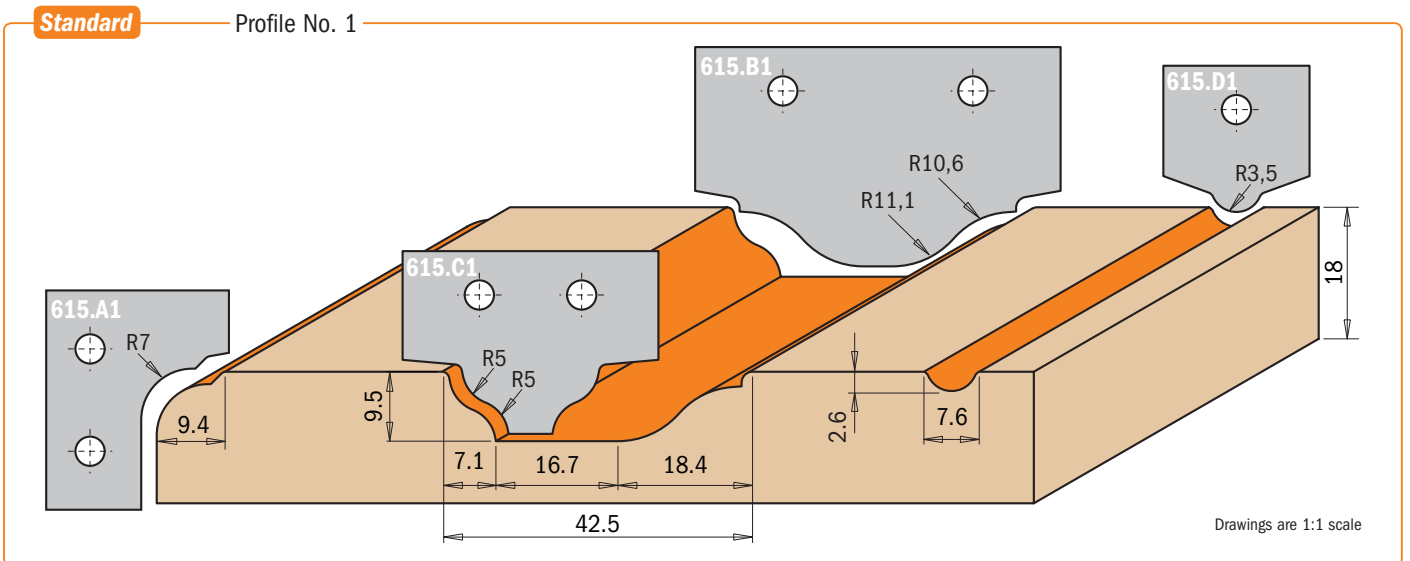
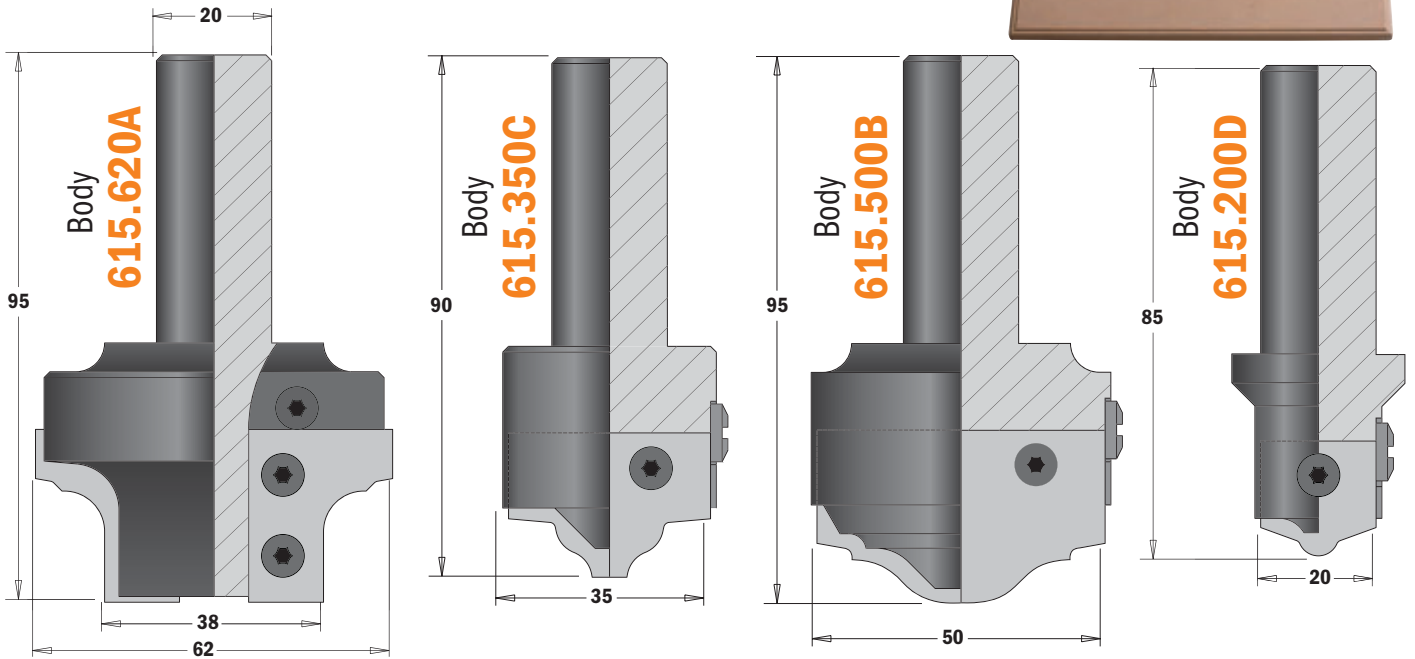

DESCRIPTION	S mm	ORDER NO. Right-hand rotation
Complete set for MDF doors (Profile no. 1)	20	615.004.01

Saw blades
Jig saw blades
Tools with bore & Knives
Router bits & sets
CNC router cutter & chucks
Industrial dowel drills
Bits for hand power tools
Power tools & accessories
Display cabinets & spare parts

Optional

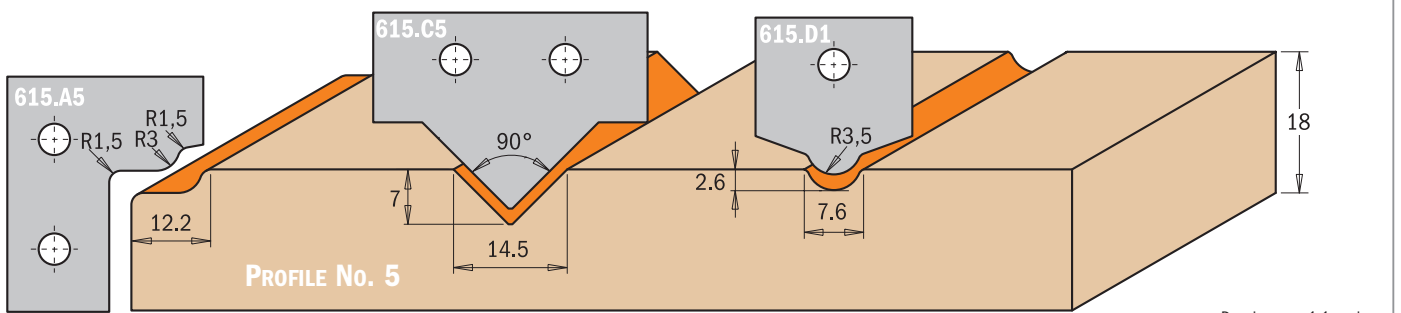
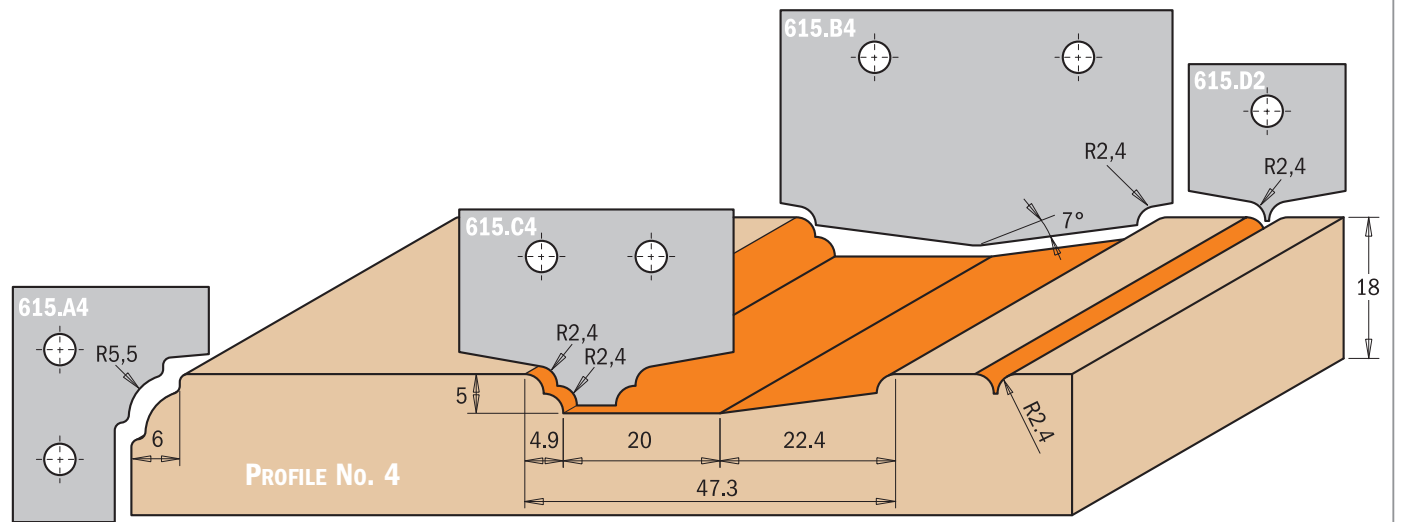
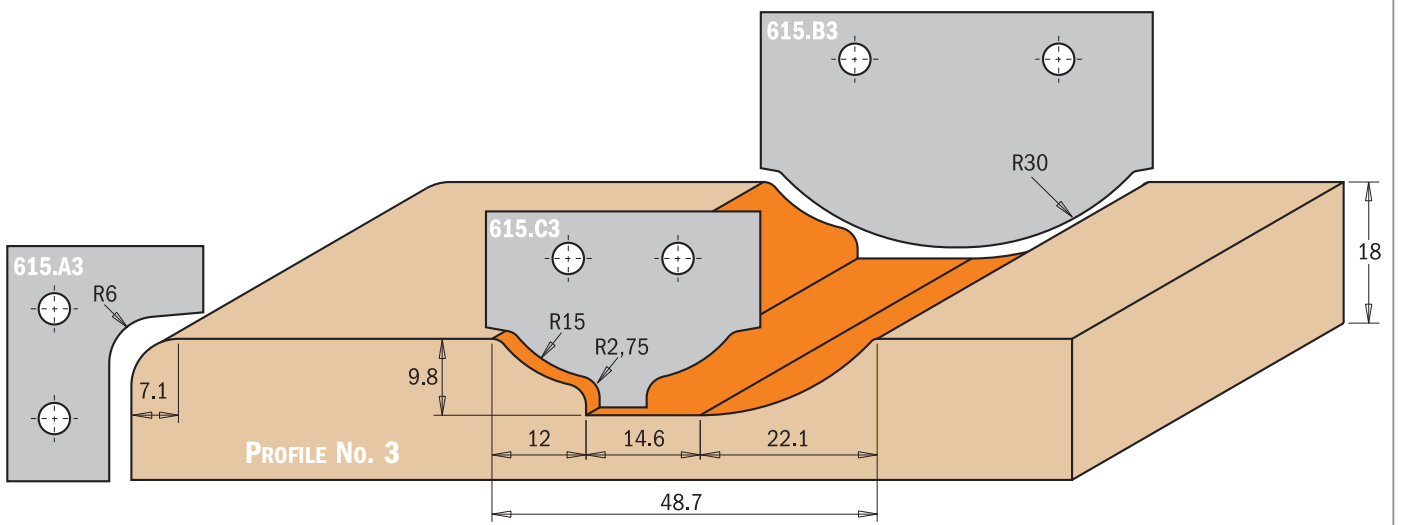
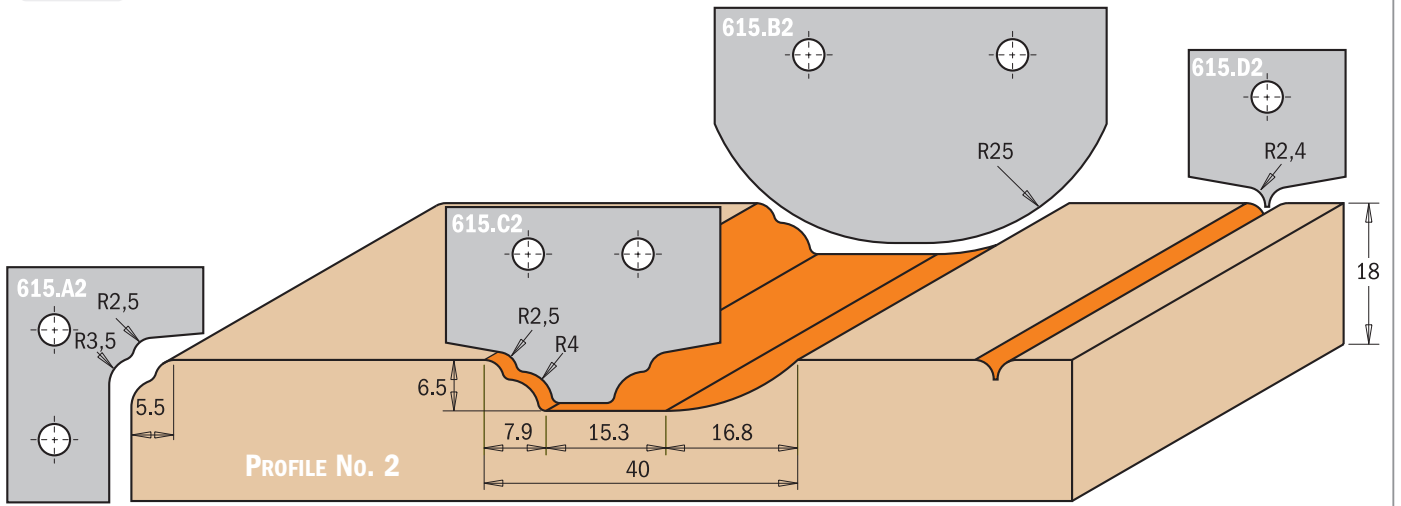

Drawings are 1:1 scale

Saw blades

Jig saw blades

Tools with bore & Knives

Router bits & sets

CNC router cutter & chucks

Industrial dowel drills

Bits for hand power tools

Power tools & accessories

Display cabinets & spare parts

Slot and mortise boring bits

HW Z2 RH

163

D mm	L mm	S mm	ORDER NO. Right-hand rotation
12	100	M12x1	163.120.11
14	100	M12x1	163.140.11
16	100	M12x1	163.160.11

TECHNICAL DETAILS:

- Super strength steel.
- 2 HW precision ground cutting edges [Z2].

APPLICATION: used for cutting mortises and slots in solid wood and wood composites. Assembled in chucks.

163
HL Z2 RH

D mm	L mm	S mm	ORDER NO. Right-hand rotation
12	100	M12x1	163.120.31
14	100	M12x1	163.140.31
16	100	M12x1	163.160.31
18	100	M12x1	163.180.31

TECHNICAL DETAILS:

- Long lasting cutter performance.
- 2 HL precision ground cutting edges [Z2].

APPLICATION: used for cutting mortises and slots in solid wood and wood composites. Assembled in chucks.

Slot and mortise boring bits

164
HW Z2 V2 RH

D mm	L mm	S mm	ORDER NO. Right-hand rotation
18	100	M12x1	164.180.11
20	100	M12x1	164.200.11
22	100	M12x1	164.220.11

TECHNICAL DETAILS:

- Super strength steel.
- HW cutting head with precision balanced centre point.
- 2 HW precision ground cutting edges [Z2].
- 2 negatively ground spurs [V2].

APPLICATION: used for drilling blind holes in solid wood, wood composites, plastic and laminated materials. Used on slot and mortise machines equipped with chucks.

164
HL Z2 V2 RH

D mm	L mm	S mm	ORDER NO. Right-hand rotation
15	100	M12x1	164.150.31
18	100	M12x1	164.180.31
20	100	M12x1	164.200.31
24	100	M12x1	164.240.31

TECHNICAL DETAILS:

- Long lasting cutter performance.
- HL cutting head with precision balanced centre point.
- 2 precision ground edges [Z2].
- 2 ground spurs [V2].

APPLICATION: used for drilling blind holes in soft and hardwood. Used on slot and mortise machines equipped with chucks.

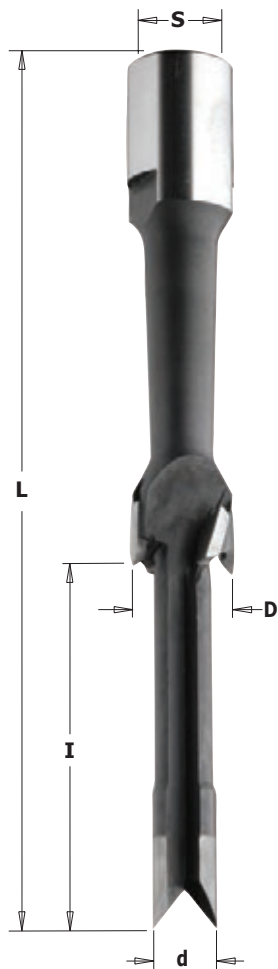

166-167



d mm	D mm	I mm	L mm	S mm	ORDER NO. Right-hand rotation
11	19	62	155	M12x1	166.190.11
11	22	62	155	M12x1	166.220.11
12	19	62	155	M12x1	167.190.11
12	24	62	155	M12x1	167.240.11

TECHNICAL DETAILS:

- Super strength steel.
- 2+2 HW precision ground cutting edges [Z2].
- 2 negatively ground spurs [V2].

APPLICATION: used for drilling and cutting mortise slots in solid wood, wood composites, plastic and laminated materials.

Lockset bits



169



D mm	I mm	L mm	S mm	ORDER NO. Right-hand rotation
15	22	90	M12x1	169.150.31
18	22	90	M12x1	169.180.31
20	22	90	M12x1	169.200.31

TECHNICAL DETAILS:

- Long-lasting cutting performance.
- 3 HL precision ground cutting edges [Z3].

APPLICATION: used for cutting mortise slots in soft and hardwood. Used on slot and mortise machines equipped with chucks.

Slot mortising bits with chip-breaker



102

HL Z2 RH LH

D mm	I mm	L mm	S mm	ORDER NO. Right-hand rotation	ORDER NO. Left-hand rotation
6	50	105	16	102.060.31	102.060.32
7	55	110	16	102.070.31	102.070.32
8	60	115	16	102.080.31	102.080.32
9	65	120	16	102.090.31	102.090.32
10	70	125	16	102.100.31	102.100.32
11	75	130	16	102.110.31	102.110.32
12	80	135	16	102.120.31	102.120.32
13	85	140	16	102.130.31	102.130.32
14	90	145	16	102.140.31	102.140.32
15	95	150	16	102.150.31	102.150.32
16	100	155	16	102.160.31	102.160.32
17	105	160	16	102.170.31	102.170.32
18	110	165	16	102.180.31	102.180.32
19	115	170	16	102.190.31	102.190.32
20	120	175	16	102.200.31	102.200.32
22	125	180	16	102.220.31	102.220.32
24	125	180	16	102.240.31	102.240.32

172

D mm	I mm	L mm	S mm	ORDER NO. Right-hand rotation	ORDER NO. Left-hand rotation
6	50	105	13	172.060.31	172.060.32
7	55	110	13	172.070.31	172.070.32
8	60	115	13	172.080.31	172.080.32
9	65	120	13	172.090.31	172.090.32
10	70	125	13	172.100.31	172.100.32
11	75	130	13	172.110.31	172.110.32
12	80	135	13	172.120.31	172.120.32
13	85	140	13	172.130.31	172.130.32
14	90	145	13	172.140.31	172.140.32
15	95	150	13	172.150.31	172.150.32
16	100	155	13	172.160.31	172.160.32
18	110	165	13	172.180.31	172.180.32
20	120	175	13	172.200.31	172.200.32

TECHNICAL DETAILS:

- Long-lasting cutting performance.
- 2 HL precision ground straight cutting edges with chip-breaker teeth [Z2].

APPLICATION: for cutting mortise slots in soft and hardwood.
Used on machining centres equipped with chucks.

6 piece mortising bit sets



102-172

HL Z2 RH LH

Ideal for heavy mortise jobs.
Made of super strength high speed steel and available in left-hand or right-hand rotation.
Safely packaged in a hardwood and glass box for protection, these sets are economical and a perfect addition to any workshop.

S mm	D mm	ORDER NO. Right-hand rotation	ORDER NO. Left-hand rotation
16	6-8-10-12-14-16	102.001.00	102.001.10
13	6-8-10-12-14-16	172.001.00	172.001.10

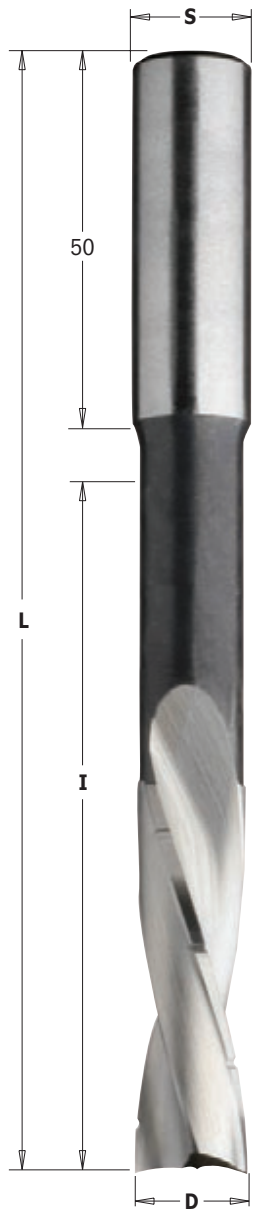

161

SP Z2 RH LH

D mm	I mm	L mm	S mm	ORDER NO. Right-hand rotation	ORDER NO. Left-hand rotation
6	60	120	16	161.060.31	161.060.32
8	70	130	16	161.080.31	161.080.32
10	80	140	16	161.100.31	161.100.32
12	90	150	16	161.120.31	161.120.32
14	100	160	16	161.140.31	161.140.32
16	110	170	16	161.160.31	161.160.32

160

SP Z2 RH LH

D mm	I mm	L mm	S mm	ORDER NO. Right-hand rotation	ORDER NO. Left-hand rotation
6	60	120	13	160.060.31	160.060.32
8	70	130	13	160.080.31	160.080.32
10	80	140	13	160.100.31	160.100.32
12	90	150	13	160.120.31	160.120.32
14	100	160	13	160.140.31	160.140.32
16	110	170	13	160.160.31	160.160.32

TECHNICAL DETAILS:

- Long-lasting cutting performance.
- 2 SP precision ground twisted cutting edges with chip-breaker teeth [Z2].

APPLICATION: for cutting mortise slots in soft and hardwood.
Used on machining centres equipped with chucks.

6 piece mortising bit sets



160-161

SP Z2 RH LH

Ideal for heavy mortise jobs.
Made of super strength high speed steel and available in left-hand or right-hand rotation.
Safely packaged in a hardwood and glass box for protection, these sets are economical and a perfect addition to any workshop.

S mm	D mm	ORDER NO. Right-hand rotation	ORDER NO. Left-hand rotation
16	6-8-10-12-14-16	161.001.00	161.001.10
13	6-8-10-12-14-16	160.001.00	160.001.10

Reciprocating slot mortising bits

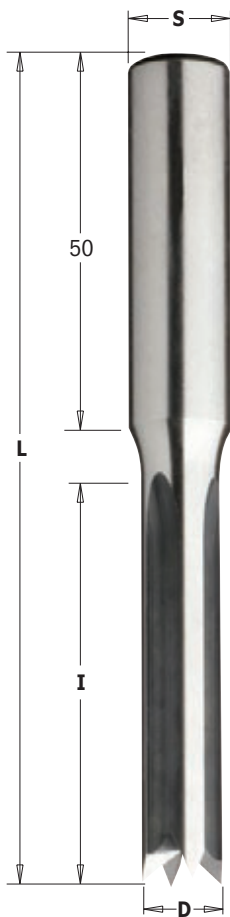

104

HL **Z4** **RH**
LH

D	I	L	S	ORDER NO.
mm	mm	mm	mm	Right-hand & Left-hand rotation
6	45	100	13	104.060.30
7	45	100	13	104.070.30
8	45	100	13	104.080.30
9	45	100	13	104.090.30
10	55	110	13	104.100.30
11	55	110	13	104.110.30
12	55	110	13	104.120.30
13	55	110	13	104.130.30
14	55	110	13	104.140.30
15	55	110	13	104.150.30
16	55	110	13	104.160.30

TECHNICAL DETAILS:

- Long-lasting cutting performance.
- 4 HL precision ground cutting edges [Z4].

APPLICATION: used for cutting mortise slots in soft and hardwood. Used on machining centres equipped with chucks.

Reciprocating slot mortising bits

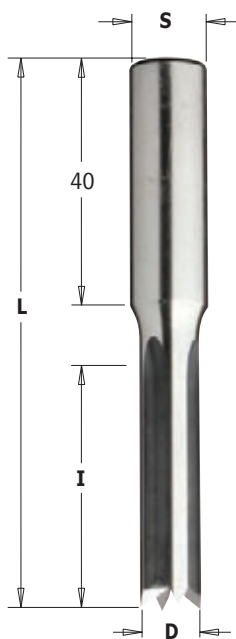

105

HL **Z4** **RH**
LH

D	I	L	S	ORDER NO.
mm	mm	mm	mm	Right-hand & Left-hand rotation
6	28	73	10	105.060.30
7	28	73	10	105.070.30
8	28	73	10	105.080.30
9	28	73	10	105.090.30
10	28	73	10	105.100.30
11	28	73	10	105.110.30
12	28	73	10	105.120.30
13	28	73	10	105.130.30
14	28	73	10	105.140.30
15	28	73	10	105.150.30
16	28	73	10	105.160.30

TECHNICAL DETAILS:

- Long-lasting cutting performance.
- 4 HL precision ground cutting edges [Z4].

APPLICATION: used for cutting mortise slots in soft and hardwood. Used on machining centres equipped with chucks.

Reciprocating slot mortising bits

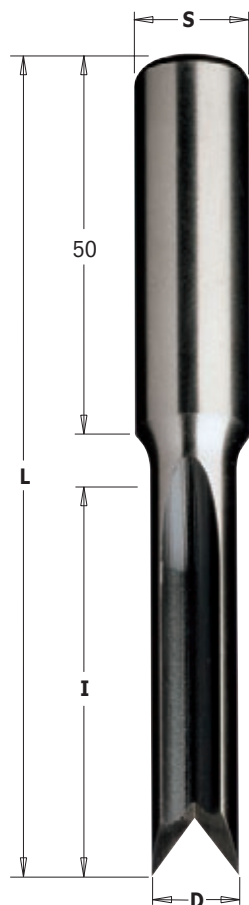

103

HL Z2 RH LH

D	I	L	S	ORDER NO.
mm	mm	mm	mm	Right-hand & Left-hand rotation
6	45	100	16	103.060.30
7	45	100	16	103.070.30
8	45	100	16	103.080.30
9	45	100	16	103.090.30
10	55	110	16	103.100.30
11	55	110	16	103.110.30
12	55	110	16	103.120.30
13	55	110	16	103.130.30
14	55	110	16	103.140.30
15	55	110	16	103.150.30
16	55	110	16	103.160.30

TECHNICAL DETAILS:

- Long-lasting cutter performance.
- 2 HL precision ground cutting edges [Z2].

APPLICATION: used for cutting mortise slots in soft and hardwood. Used on machining centres equipped with chucks.

Reciprocating slot mortising bits

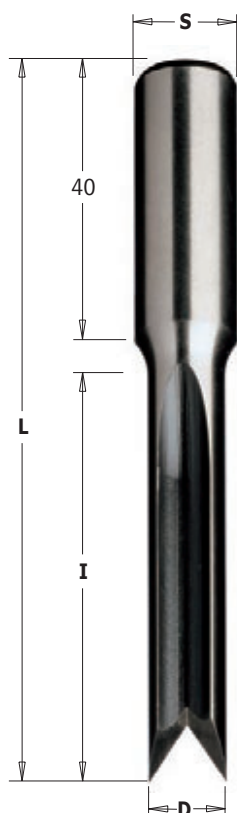

179

HS Z2 RH LH

D	I	L	S	ORDER NO.
mm	mm	mm	mm	Right-hand & Left-hand rotation
6	45	90	13	179.060.50
7	50	95	13	179.070.50
8	50	95	13	179.080.50
9	55	100	13	179.090.50
10	60	105	13	179.100.50
11	65	110	13	179.110.50
12	70	115	13	179.120.50
13	75	120	13	179.130.50

TECHNICAL DETAILS:

- Long-lasting cutter performance.
- 2 HS precision ground cutting edges [Z2].

APPLICATION: used for cutting mortise slots in soft and hardwood. Used on machining centres equipped with chucks.

Reciprocating slot mortising bits

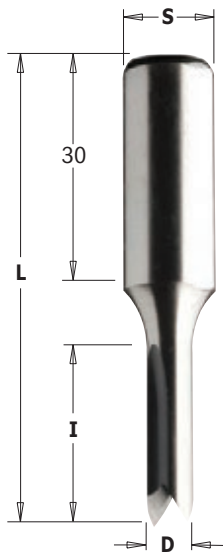

106

HL	Z2	Z4	RH LH
----	----	----	----------

D mm	I mm	L mm	S mm	Z	ORDER NO. Right-hand & Left-hand rotation
6	25	60	12	2	106.060.30
7	25	60	12	2	106.070.30
8	25	60	12	2	106.080.30
9	25	60	12	2	106.090.30
10	25	60	12	4	106.100.30
11	25	60	12	4	106.110.30
12	25	60	12	4	106.120.30
13	25	60	12	4	106.130.30
14	25	60	12	4	106.140.30
15	25	60	12	4	106.150.30

TECHNICAL DETAILS:

- Long-lasting cutter performance.
- 2 or 4 HL precision ground cutting edges [Z2-Z4].

Slot mortising bits

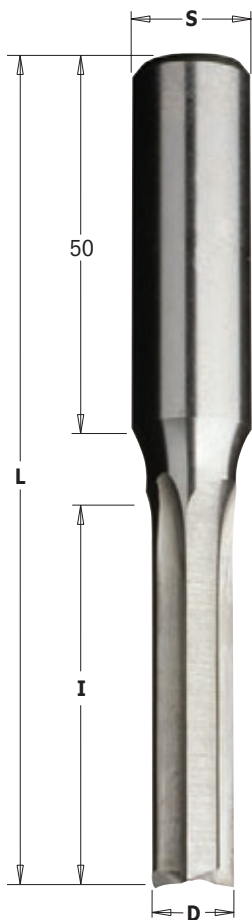

107

HL	Z3	RH	LH
----	----	----	----

D mm	I mm	L mm	S mm	ORDER NO. Right-hand rotation	ORDER NO. Left-hand rotation
6	55	110	16	107.060.31	107.060.32
8	55	110	16	107.080.31	107.080.32
10	55	110	16	107.100.31	107.100.32
12	55	110	16	107.120.31	107.120.32
14	60	115	16	107.140.31	107.140.32
16	60	115	16	107.160.31	107.160.32
18	60	115	16	107.180.31	107.180.32
20	60	115	16	107.200.31	107.200.32

TECHNICAL DETAILS:

- Long-lasting cutter performance.
- 3 HL precision ground cutting edges [Z3].

APPLICATION: used for cutting mortise slots in soft and hardwood. Used in machining centres equipped with chucks.

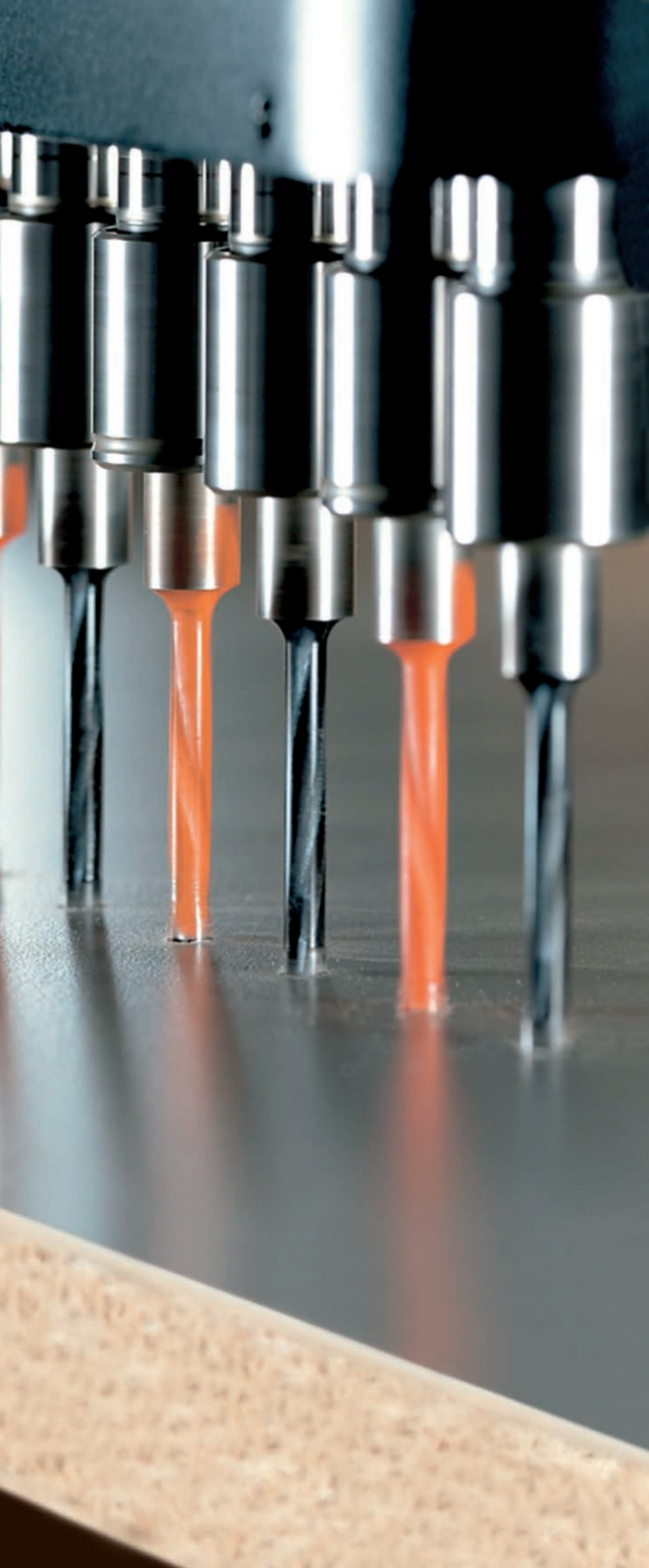

Industrial dowel drills

PRODUCTS	PAGE
Adaptors	226 ~ 228
XTreme solid carbide boring bits	229 ~ 231
XTreme boring bits	232 - 233
Solid carbide twist drills	234 - 235
2 flute dowel drills	236 - 237
4 flute dowel drills	238 ~ 240
Dowel drills with countersink	241
Through hole dowel drills	242 - 243
Countersinks	244
Hinge boring bits	245 - 246
Dowel drills with threaded shank	247 ~ 250

Adaptors

Saw blades

Jig saw blades

Tools with bore & Knives

Router bits & sets

CNC router cutter & chucks

Industrial dowel drills

Bits for hand power tools

Power tools & accessories

Display cabinets & spare parts



301

RH LH

D ₃ mm	D ₂ mm	S mm	ORDER NO. Right-hand rotation	ORDER NO. Left-hand rotation
8	16	M8	301.080.01	301.080.02
10	19,5	M8	301.000.01	301.000.02

For use on the following machines:
Nottmeyer (older models).

Spare parts



990.006.00 991.062.00

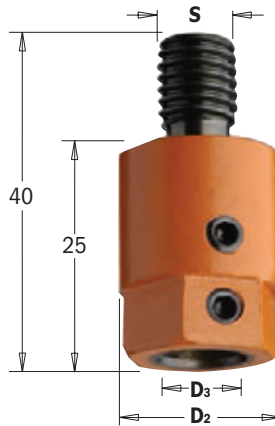

302

RH LH

D ₃ mm	D ₂ mm	S mm	ORDER NO. Right-hand rotation	ORDER NO. Left-hand rotation
8	16	M10	302.080.01	302.080.02
10	19,5	M10	302.000.01	302.000.02

For use on the following machines:
Ayen, Holzma, Knoevenagel, Mayer, Torwegge.

Spare parts



990.006.00 991.062.00



303

RH LH

D ₃ mm	D ₂ mm	S mm	ORDER NO. Right-hand rotation	ORDER NO. Left-hand rotation
8	16	M10/30°	303.080.01	303.080.02
10	19,5	M10/30°	303.000.01	303.000.02

For use on the following machines:
Alberti (older models).
Balestrini, Bilek, Busellato (older models).
Schleicher, Vitap (older models).

Spare parts



990.006.00 991.062.00

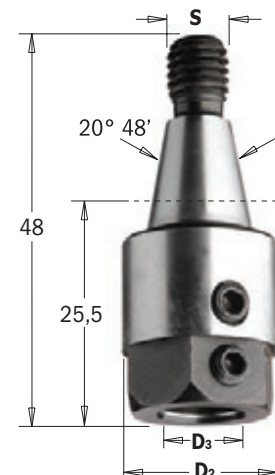

304

RH LH

D ₃ mm	D ₂ mm	S mm	ORDER NO. Right-hand rotation	ORDER NO. Left-hand rotation
8	16	M8/20° 48'	304.080.01	304.080.02
10	19,5	M8/20° 48'	304.000.01	304.000.02

For use on the following machines:
Balestrini, Bilek.

Spare parts



990.006.00 991.062.00

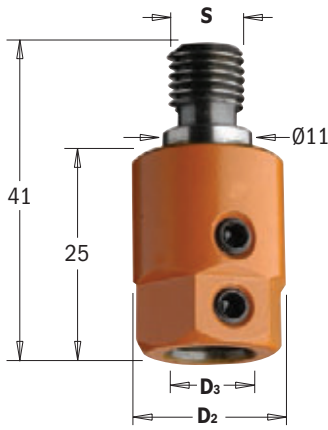

305

RH LH

D ₃ mm	D ₂ mm	S mm	ORDER NO. Right-hand rotation	ORDER NO. Left-hand rotation
8	16	M10/11	305.080.01	305.080.02
10	19,5	M10/11	305.000.01	305.000.02

For use on the following machines:
 Biesse (older models).
 Masterwood (Zangheri & Boschetti).
 Morbidelli, Torwegge, Vitap (new design).
 Weeke.

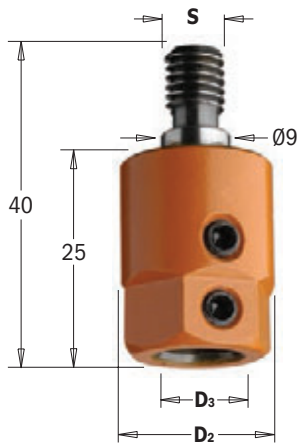

358

RH LH

D ₃ mm	D ₂ mm	S mm	ORDER NO. Right-hand rotation	ORDER NO. Left-hand rotation
8	16	M8/9	358.080.01	358.080.02
10	19,5	M8/9	358.000.01	358.000.02

For use on the following machines:
 Masterwood (Zangheri & Boschetti).
 Morbidelli, Nottmeyer (new design).



359

RH LH

D ₃ mm	D ₂ mm	S mm	ORDER NO. Right-hand rotation	ORDER NO. Left-hand rotation
10	19,5	M10	359.000.01	359.000.02

For use on the following machines:
 Scheer.

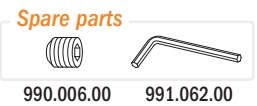

360.001

RH LH

D ₃ mm	D ₂ mm	ORDER NO. Right-hand rotation	ORDER NO. Left-hand rotation
10	20	360.001.01	360.001.02

For use on the following machines:
 For Biesse machines with quick drill change attachment.

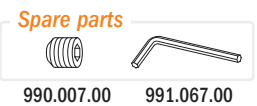

Saw blades
 Jig saw blades
 Tools with bore & Knives
 Router bits & sets
 CNC router cutter & chucks
 Industrial dowel drills
 Bits for hand power tools
 Power tools & accessories
 Display cabinets & spare parts

Adaptors

Saw blades

Jig saw blades

Tools with bore & Knives

Router bits & sets

CNC router cutter & chucks

Industrial dowel drills

Bits for hand power tools

Power tools & accessories

Display cabinets & spare parts



360.101



D₃ mm	D₂ mm			ORDER NO. Right-hand & Left-hand rotation
10	18			360.101.00

For use on the following machines:
Vitap.

Spare parts



990.015.00 991.062.00



360.201



D₃ mm	D₂ mm			ORDER NO. Right-hand & Left-hand rotation
10	19,25			360.201.00

For use on the following machines:
Morbidelli.

Spare parts



990.015.00 991.062.00



360.301



D₃ mm	D₂ mm			ORDER NO. Right-hand & Left-hand rotation
10	19,4			360.301.00

For use on the following machines:
Masterwood.

Spare parts



990.015.00 991.062.00



360.401



D₃ mm	D₂ mm			ORDER NO. Right-hand & Left-hand rotation
10	20			360.401.00

For use on the following machines:
Weeke.

Spare parts



990.009.00 991.067.00



990.088



DESCRIPTION	ORDER NO. Right-hand & Left-hand rotation
Retaining screw for Weeke machines	990.088.00

X TREME BORING BITS

Setting a new standard for performance and value

NEW DOWNCUT ROUND SHARPENING

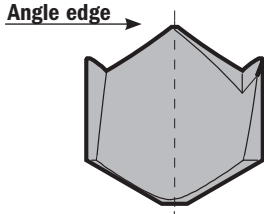

EXTRA-FINE MICROGRAIN CARBIDE

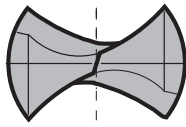

Reduced boring surface
for faster feed speed

STANDARD SHARPENING

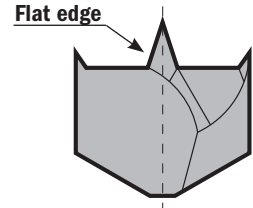

STANDARD CARBIDE

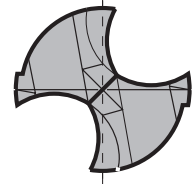

Standard boring surface

The finest industrial quality micrograin carbide

CMT makes the finest quality cutting edges. Produced by Ceratizit in Luxembourg, CMT's carbide tips are selected among many carbide grades to ensure longer endurance and higher impact resistance.

P.T.F.E. Coating

CMT's P.T.F.E. coating provides a non-stick surface preventing any residue accumulation on the bit body. Baked on at 420°, this unique industrial material is specifically designed to fit woodworking tool requirements.

Highly-resistant steel body

Our bit bodies and shanks are machined from solid bar stock steel made by Von Moos Steel in Switzerland. The main mechanical properties are:

- superior strength
- high level uniformity
- minimal distortion
- exceptional resistance to fatigue and abrasion.



Micrograin carbide sharpening

Sharpening on the carbide cutting edges provides a 0,4µ/mm micrograin finish. This is processed on automated CNC machines equipped with as many as 6 axes for maximum accuracy

Special metal shock resistant brazing

Micrograin carbide tips are applied with a special brazing compound. This allows a higher brazing temperature than other methods and guarantees a solid bond of every tip on every bit.

Steel shank grinding

CMT grinds the steel shank to a micrograin finish of 0,8µ/mm. The smooth finish on the shank determines how well the drills fit into your machine. Rough grinding results in a poor chuck grip and in a poor wobbly rotation.

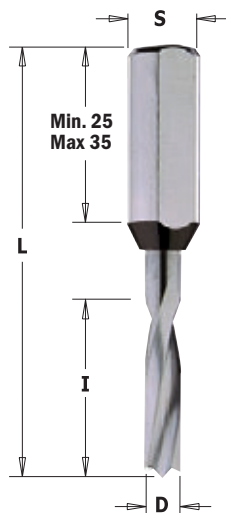

310.21/22 XtreME



D mm	I mm	L mm	S mm	ORDER NO.	
				Right-hand rotation	Left-hand rotation
1,3	5	57,5	10x30	310.013.20*	
2	12	57,5	10x27	310.020.21	310.020.22
3	9	57,5	10x35	310.530.21	310.530.22
3	18	57,5	10x25	310.030.21	310.030.22
4	20	57,5	10x25	310.040.21	310.040.22
5	22	57,5	10x27	310.050.21	310.050.22
6	22	57,5	10x25	310.060.21	310.060.22
6,35 (1/4")	22	57,5	10x25	310.064.21	310.064.22
8	22	57,5	10x25	310.080.21	310.080.22

* Boring bit for panel preboring.
Suitable for both right-hand and left-hand rotation.

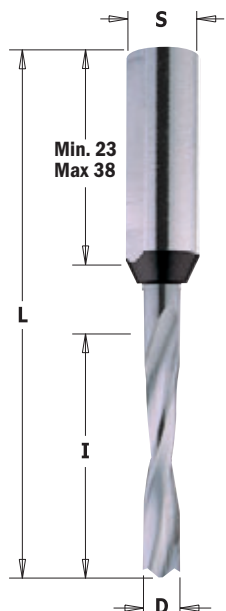
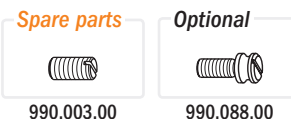

311.21/22 XtreME



D mm	I mm	L mm	S mm	ORDER NO.	
				Right-hand rotation	Left-hand rotation
1,3	5	70	10x45	311.013.20*	
2	12	70	10x39	311.020.21	311.020.22
3	18	70	10x38	311.030.21	311.030.22
4	27	70	10x30	311.040.21	311.040.22
5	30	70	10x28	311.050.21	311.050.22
6	30	70	10x29	311.060.21	311.060.22
6,35 (1/4")	30	70	10x29	311.064.21	311.064.22
8	35	70	10x22	311.080.21	311.080.22

* Boring bit for panel preboring.
Suitable for both right-hand and left-hand rotation.

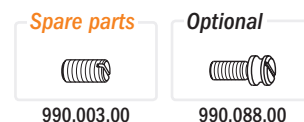

TECHNICAL DETAILS:

- Premium quality super-strength steel.
- HWM spiral portion with centre point.
- 2 cutting edges [Z2].
- 2 spiral flutes.
- 2 curved, negatively ground spurs [V2].
- Parallel shank with driving flat and adjustable screw length.

APPLICATION: used on boring machines separately or with chucks for drilling blind holes in solid wood, wood composites, plastic and laminated materials.

Perfect for all materials and long-lasting performance!

CMT announces the new series of solid carbide boring bits, now available from their extensive industrial line. These bits are entirely made of premium quality super micrograin carbide from Ceratizit in Luxemburg.

The entire series offers several design features:

- the unique tip has curved, negatively ground spurs to produce exceptionally clear bores with no rough edges. Centre point balanced;
- the cylindrical head is bigger than traditional tips and is extremely resistant to prolonged use.

It lasts longer between sharpenings;

- the plunge edge runs all the way to the centre of the bit to reduce drilling resistance and increase production speed;
- the solid carbide construction guarantees an almost infinite number of resharpenings, and since it is a solid unit of carbide, it offers extra safety features;
- ideal for hardwood and difficult composites such as particle boards, MDF and veneered wood.
- excellent performance on high-speed boring units and CNC routers.

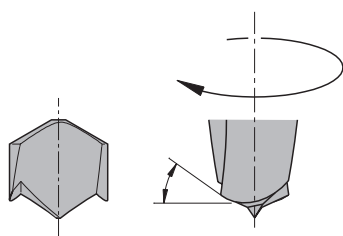

Xtreme sharpening

Solid carbide dowel drills for through holes

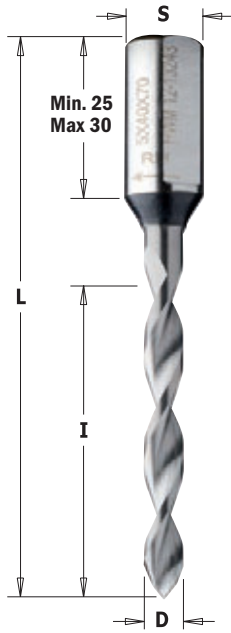

314.21/22

XTREME



HWM LONG LIFE Z2 RH LH

D	I	L	S	ORDER NO.	ORDER NO.
mm	mm	mm	mm	Right-hand rotation	Left-hand rotation
3	27	70	10x30	314.030.21	314.030.22
4	35	70	10x26	314.040.21	314.040.22
5	35	70	10x26	314.050.21	314.050.22
6	35	70	10x26	314.060.21	314.060.22
8	35	70	10x26	314.080.21	314.080.22

For panels with maximum 20-30mm in thickness

TECHNICAL DETAILS:

- Premium quality super-strength steel.
- HWM spiral portion with centre point.
- 2 precision ground cutting edges [Z2].
- Double angle.
- 2 spiral flutes.
- Parallel shank with driving flat and adjustable screw length.

Spare parts	Optional
 990.008.00	 990.088.00

APPLICATION: used on boring machines and dowel drilling devices.

Use for drilling through holes in solid wood, wood composites, plastic and laminated materials.

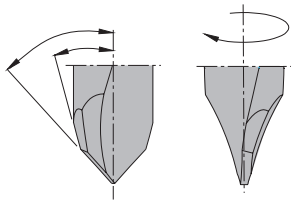

XTreme sharpening

Grinding wheels for XTreme sharpening

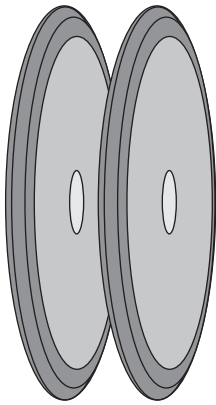

01.02

D	DESCRIPTION	DIMENSION	B	ORDER NO.
mm		mm	mm	
Ø3 a 7	Grinding wheel for resharpening	Ø125x5,5	Ø20	01.02.0316
Ø8 a 10	Grinding wheel for resharpening	Ø125x7	Ø20	01.02.0317

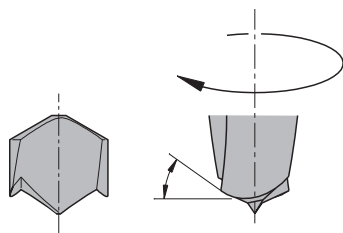
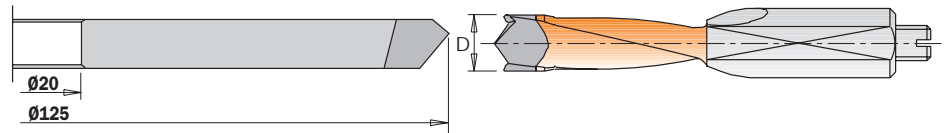

XTreme sharpening

Dowel drills

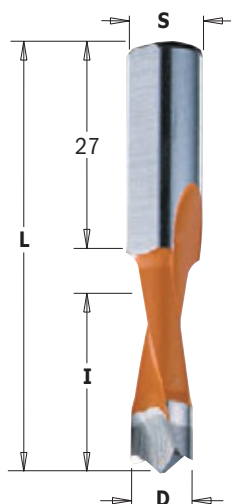

310.41/42 XTREME



D mm	I mm	L mm	S mm	ORDER NO. Right-hand rotation	ORDER NO. Left-hand rotation
5	27	57,5	10x27	310.050.41	310.050.42
6	27	57,5	10x27	310.060.41	310.060.42
7	27	57,5	10x27	310.070.41	310.070.42
8	27	57,5	10x27	310.080.41	310.080.42
9	27	57,5	10x27	310.090.41	310.090.42
10	27	57,5	10x27	310.100.41	310.100.42

TECHNICAL DETAILS:

- Premium quality super-strength steel.
- Spiral portion coated with orange or black P.T.F.E.
- Extra-fine micrograin carbide spiral portion with centre point.
- 2 cutting edges [Z2].
- 2 spiral flutes.
- 2 curved, negatively ground spurs [V2].
- Parallel shank with driving flat and adjustable screw length.

Spare parts

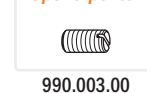

Optional



APPLICATION: used on boring machines separately or with chucks for drilling blind holes in solid wood, wood composites, plastic and laminated materials.

Dowel drills

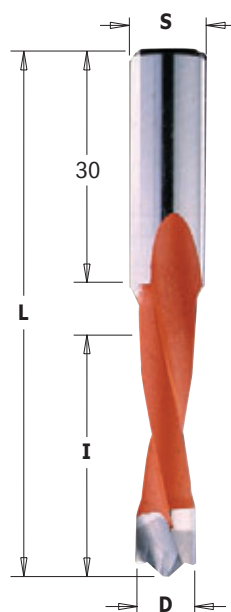

311.41/42 XTREME



D mm	I mm	L mm	S mm	ORDER NO. Right-hand rotation	ORDER NO. Left-hand rotation
5	35	70	10x30	311.050.41	311.050.42
6	35	70	10x30	311.060.41	311.060.42
7	35	70	10x30	311.070.41	311.070.42
8	35	70	10x30	311.080.41	311.080.42
9	35	70	10x30	311.090.41	311.090.42
10	35	70	10x30	311.100.41	311.100.42

TECHNICAL DETAILS:

- Premium quality super-strength steel.
- Spiral portion coated with orange or black P.T.F.E.
- Extra-fine micrograin carbide spiral portion with centre point.
- 2 cutting edges [Z2].
- 2 spiral flutes.
- 2 curved, negatively ground spurs [V2].
- Parallel shank with driving flat and adjustable screw length.

Spare parts

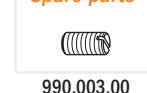

Optional



APPLICATION: used on boring machines separately or with chucks for drilling blind holes in solid wood, wood composites, plastic and laminated materials.

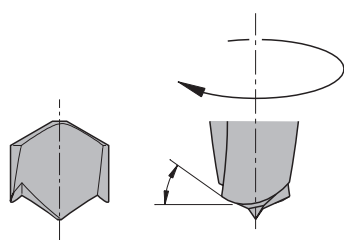

Xtreme sharpening

Perfect for all materials and long-lasting performance!

CMT announces the new series of solid carbide boring bits, now available from their extensive industrial line. These bits are entirely made of premium quality super micrograin carbide from Ceratizit in Luxembourg.

The entire series offers several design features:

- the unique tip has curved, negatively ground spurs to produce exceptionally clear bores with no rough edges. Centre point balanced;
- the cylindrical head is bigger than traditional tips and is extremely resistant to prolonged use.

It lasts longer between sharpenings;

- the plunge edge runs all the way to the centre of the bit to reduce drilling resistance and increase production speed;
- the solid carbide construction guarantees an almost infinite number of resharpenings, and since it is a solid unit of carbide, it offers extra safety features;
- ideal for hardwood and difficult composites such as particle boards, MDF and veneered wood.
- excellent performance on high-speed boring units and CNC routers.

Dowel drills for through holes

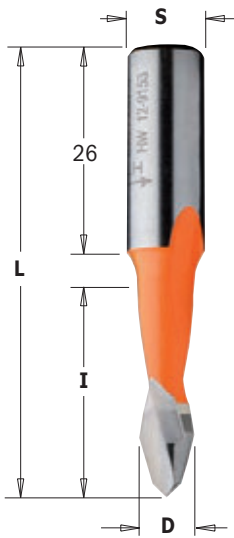

313.41/42

XTRME



D mm	I mm	L mm	S mm	ORDER NO. Right-hand rotation	ORDER NO. Left-hand rotation
5	27	57,5	10x26	313.050.41	313.050.42
8	27	57,5	10x26	313.080.41	313.080.42

For panels with maximum 20mm in thickness

TECHNICAL DETAILS:

- Super-strength steel.
- Spiral portion coated with orange or black P.T.F.E.
- Extra-fine micrograin carbide spiral portion with centre point.
- HW head with precision balanced centre point.
- 2 precision ground cutting edges [Z2].
- Double angle.
- 2 spiral flutes.
- Parallel shank with driving flat and length adjusting screw.

APPLICATION: used on boring machines and dowel drilling devices. Use for drilling through holes in solid wood, wood composites, plastic and laminated materials.

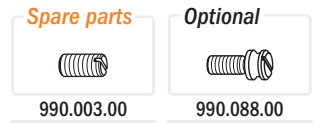

Dowel drills for through holes

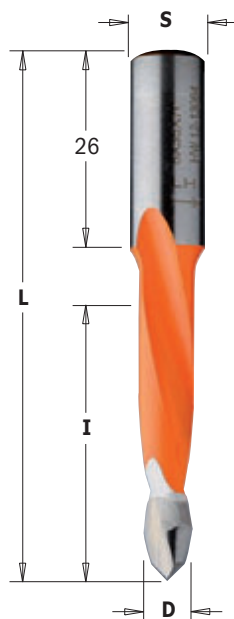

314.41/42

XTRME



D mm	I mm	L mm	S mm	ORDER NO. Right-hand rotation	ORDER NO. Left-hand rotation
5	35	70	10x26	314.050.41	314.050.42
6	35	70	10x26	314.060.41	314.060.42
7	35	70	10x26	314.070.41	314.070.42
8	35	70	10x26	314.080.41	314.080.42
10	35	70	10x26	314.100.41	314.100.42

For panels with maximum 30mm in thickness

TECHNICAL DETAILS:

- Super-strength steel.
- Spiral portion coated with orange or black P.T.F.E.
- Extra-fine micrograin carbide spiral portion with centre point.
- HW head with precision balanced centre point.
- 2 precision ground cutting edges [Z2].
- Double angle.
- 2 spiral flutes.
- Parallel shank with driving flat and length adjusting screw.

APPLICATION: used on boring machines and dowel drilling devices. Use for drilling through holes in solid wood, wood composites, plastic and laminated materials.

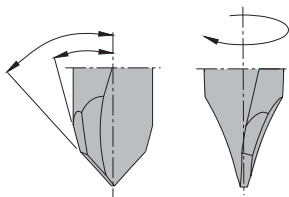
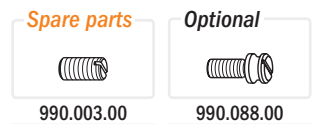

XTRme sharpening

Perfect for all materials and long-lasting performance!

CMT announces the new series of solid carbide boring bits, now available from their extensive industrial line. These bits are entirely made of premium quality super micrograin carbide from Ceratizit in Luxemburg.

The entire series offers several design features:

- the unique tip has curved, negatively ground spurs to produce exceptionally clear bores with no rough edges. Centre point balanced;
- the cylindrical head is bigger than traditional tips and is extremely resistant to prolonged use.

It lasts longer between sharpenings;

- the plunge edge runs all the way to the centre of the bit to reduce drilling resistance and increase production speed;
- the solid carbide construction guarantees an almost infinite number of resharpenings, and since it is a solid unit of carbide, it offers extra safety features;
- ideal for hardwood and difficult composites such as particle boards, MDF and veneered wood.
- excellent performance on high-speed boring units and CNC routers.

Adaptors for twist drills



364

D ₃ mm	L mm	S mm	ORDER NO.
2	38	10x20	364.020.00
2,5	38	10x20	364.025.00
3	38	10x20	364.030.00
3,2	38	10x20	364.032.00
3,5	38	10x20	364.035.00
4	38	10x20	364.040.00
4,5	38	10x20	364.045.00
5	38	10x20	364.050.00

For use with the following items: **363 HW**

TECHNICAL DETAILS:

- Super-strength steel.
- Quick and secure assembly on twist drills.
- Precision relief.
- Parallel shank with driving flat and length adjusting screw.

Spare parts



990.001.00 991.062.00

APPLICATION: for use with twist drills with common shank and bushing diametre. Used on boring machines equipped with adaptor chucks.

Bushings for twist drills

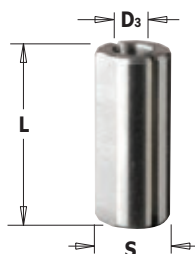

365

D ₃ mm	L mm	S mm	ORDER NO.
2	23	10	365.020.00
2,5	23	10	365.025.00
3	23	10	365.030.00
3,2	23	10	365.032.00
3,5	23	10	365.035.00
4	23	10	365.040.00
4,5	23	10	365.045.00
5	23	10	365.050.00

For use with the following items: **363 HW**

TECHNICAL DETAILS:

- Super-strength steel.
- Shank with driving flat.
- Axial cuttings for cylindrical drill clamps.

APPLICATION: used with spiral boring bits with shank diametres equal to the bushing diametre. Used on boring machines equipped with adaptors.

Solid carbide twist drills "V" point 120° sharpening

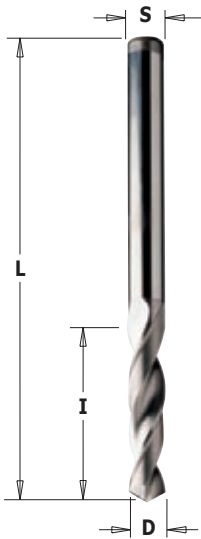

363

HWM LONG LIFE Z2 RH LH

S=D mm	I mm	L mm	ORDER NO. Right-hand rotation	ORDER NO. Left-hand rotation
2	25	50	363.020.11	363.020.12
2,5	27	55	363.025.11	363.025.12
3	27	55	363.030.11	363.030.12
3,2	27	55	363.032.11	363.032.12
3,5	27	55	363.035.11	363.035.12
4	27	55	363.040.11	363.040.12
4,5	28	60	363.045.11	363.045.12
5	28	60	363.050.11	363.050.12



"V" Point sharpening

Solid carbide twist drills negatively ground spurs sharpening

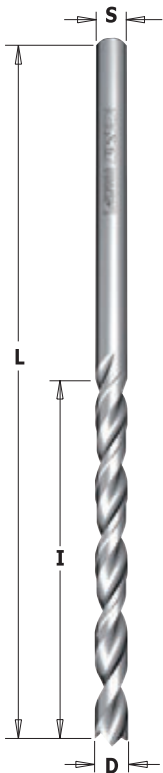

363

HWM LONG LIFE Z2 RH LH

S=D mm	I mm	L mm	ORDER NO. Right-hand rotation	ORDER NO. Left-hand rotation
2,5	27	55	363.025.21	363.025.22
3	27	55	363.030.21	363.030.22
4	27	55	363.040.21	363.040.22
5	28	60	363.050.21	363.050.22



X-Treme sharpening

For use with the following items: 364-365

TECHNICAL DETAILS:

- Premium quality HWM.
- 2 precision ground cutting edges [Z2].
- 2 spiral flutes.
- Common shank and drilling diameter (S=D).

APPLICATION: used in adaptor bushings.

Assembly Illustration



2 flute dowel drills

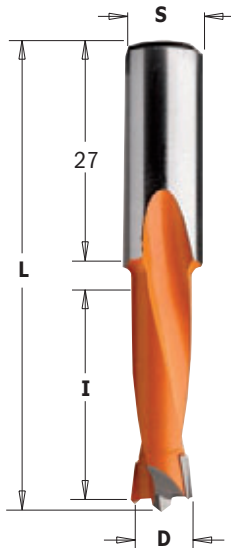

310



D mm	I mm	L mm	S mm	ORDER NO. Right-hand rotation	ORDER NO. Left-hand rotation
4	27	57,5	10x27	310.040.11	310.040.12
4,5	27	57,5	10x27	310.045.11	310.045.12
4,76	27	57,5	10x27	310.047.11	310.047.12
5	27	57,5	10x27	310.050.11	310.050.12
5,1	27	57,5	10x27	310.051.11	310.051.12
5,2	27	57,5	10x27	310.052.11	310.052.12
5,55	27	57,5	10x27	310.055.11	310.055.12
6	27	57,5	10x27	310.060.11	310.060.12
6,35	27	57,5	10x27	310.064.11	310.064.12
6,5	27	57,5	10x27	310.065.11	310.065.12
7	27	57,5	10x27	310.070.11	310.070.12
8	27	57,5	10x27	310.080.11	310.080.12
8,2	27	57,5	10x27	310.082.11	310.082.12
9	27	57,5	10x27	310.090.11	310.090.12
9,52	27	57,5	10x27	310.095.11	310.095.12
10	27	57,5	10x27	310.100.11	310.100.12
11	27	57,5	10x27	310.110.11	310.110.12
12	27	57,5	10x27	310.120.11	310.120.12
12,7	27	57,5	10x27	310.127.11	310.127.12
13	27	57,5	10x27	310.130.11	310.130.12
14	27	57,5	10x27	310.140.11	310.140.12
15	27	57,5	10x27	310.150.11	310.150.12
16	27	57,5	10x27	310.160.11	310.160.12

Spare parts



990.003.00

Optional



990.088.00

2 flute dowel drills

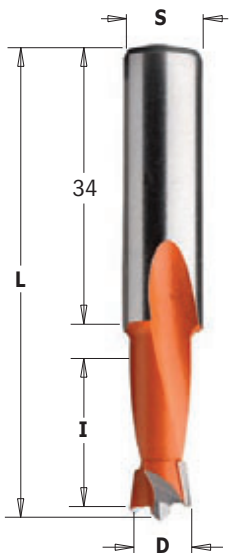

361



D mm	I mm	L mm	S mm	ORDER NO. Right-hand rotation	ORDER NO. Left-hand rotation
5	18	57,5	10x34	361.050.11	361.050.12
6	18	57,5	10x34	361.060.11	361.060.12
7	18	57,5	10x34	361.070.11	361.070.12
8	18	57,5	10x34	361.080.11	361.080.12
10	18	57,5	10x34	361.100.11	361.100.12

TECHNICAL DETAILS:

- Super-strength steel.
- Spiral portion coated with orange or black P.T.F.E.
- HW head with precision balanced centre point.
- 2 HW precision ground cutting edges [Z2].
- 2 negatively ground spurs [V2]
- 2 spiral flutes.
- Parallel shank with driving flat and length adjusting screw.

Spare parts



990.003.00

Optional



990.088.00

APPLICATION: used on boring machines equipped with adaptors or chucks. Used to drill blind holes in solid wood, wood composites, plastic and laminated materials.

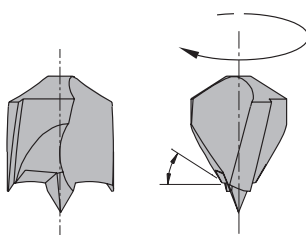

Negatively ground spurs

2 flute dowel drills

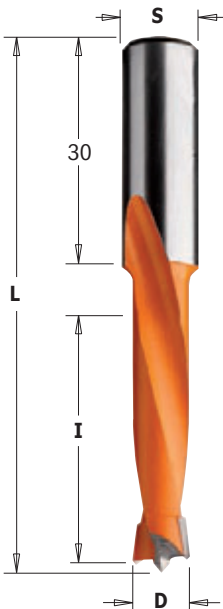

311



D mm	I mm	L mm	S mm	ORDER NO.	ORDER NO.
				Right-hand rotation	Left-hand rotation
4	35	70	10x30	311.040.11	311.040.12
4,5	35	70	10x30	311.045.11	311.045.12
4,76	35	70	10x30	311.047.11	311.047.12
5	35	70	10x30	311.050.11	311.050.12
5,1	35	70	10x30	311.051.11	311.051.12
5,2	35	70	10x30	311.052.11	311.052.12
5,55	35	70	10x30	311.055.11	311.055.12
6	35	70	10x30	311.060.11	311.060.12
6,35	35	70	10x30	311.064.11	311.064.12
6,5	35	70	10x30	311.065.11	311.065.12
7	35	70	10x30	311.070.11	311.070.12
8	35	70	10x30	311.080.11	311.080.12
8,2	35	70	10x30	311.082.11	311.082.12
9	35	70	10x30	311.090.11	311.090.12
9,52	35	70	10x30	311.095.11	311.095.12
10	35	70	10x30	311.100.11	311.100.12
11	35	70	10x30	311.110.11	311.110.12
11,1	35	70	10x30	311.111.11	311.111.12
12	35	70	10x30	311.120.11	311.120.12
12,7	35	70	10x30	311.127.11	311.127.12
13	35	70	10x30	311.130.11	311.130.12
14	35	70	10x30	311.140.11	311.140.12
15	35	70	10x30	311.150.11	311.150.12
16	35	70	10x30	311.160.11	311.160.12

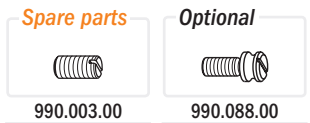

2 flute dowel drills

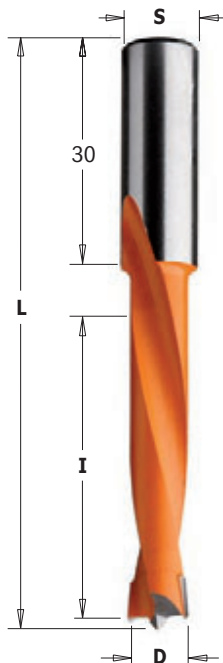

362



D mm	I mm	L mm	S mm	ORDER NO.	ORDER NO.
				Right-hand rotation	Left-hand rotation
5	44	77	10x30	362.050.11	362.050.12
6	44	77	10x30	362.060.11	362.060.12
7	44	77	10x30	362.070.11	362.070.12
8	44	77	10x30	362.080.11	362.080.12
10	44	77	10x30	362.100.11	362.100.12
12	44	77	10x30	362.120.11	362.120.12

TECHNICAL DETAILS:

- Super-strength steel.
- Spiral portion coated with orange or black P.T.F.E.
- HW head with precision balanced centre point.
- 2 HW precision ground cutting edges [Z2].
- 2 negatively ground spurs [V2].
- 2 spiral flutes.
- Parallel shank with driving flat and length adjusting screw.

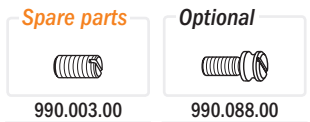

APPLICATION: used on boring machines equipped with adaptors or chucks. Used to drill blind holes in solid wood, wood composites, plastic and laminated materials.

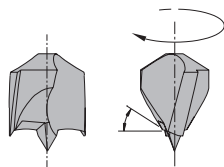

Negatively ground spurs

4 flute dowel drills

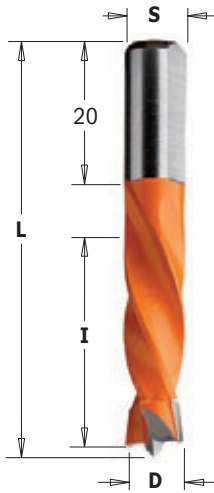

306



D	I	L	S	ORDER NO.	ORDER NO.
mm	mm	mm	mm	Right-hand rotation	Left-hand rotation
• 3	18	55,5	8x20	306.030.21	
5	30	55,5	8x20	306.050.11	306.050.12
5,55	30	55,5	8x20	306.055.11	306.055.12
6	30	55,5	8x20	306.060.11	306.060.12
6,35	30	55,5	8x20	306.064.11	306.064.12
7	30	55,5	8x20	306.070.11	306.070.12
8	30	55,5	8x20	306.080.11	306.080.12
9	30	55,5	8x20	306.090.11	306.090.12
10	30	55,5	8x20	306.100.11	306.100.12
12	30	55,5	8x20	306.120.11	306.120.12

• HWM

Spare parts



990.003.00

Optional



990.088.00

4 flute dowel drills

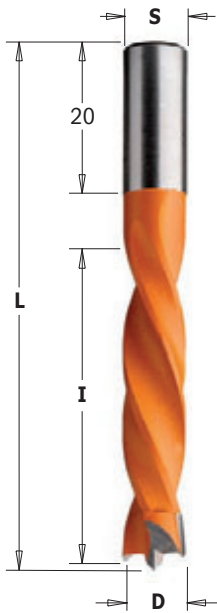

307



D	I	L	S	ORDER NO.	ORDER NO.
mm	mm	mm	mm	Right-hand rotation	Left-hand rotation
5	40	67	8x20	307.050.11	307.050.12
5,55	40	67	8x20	307.055.11	307.055.12
6	40	67	8x20	307.060.11	307.060.12
6,35	40	67	8x20	307.064.11	307.064.12
7	40	67	8x20	307.070.11	307.070.12
8	40	67	8x20	307.080.11	307.080.12
9	40	67	8x20	307.090.11	307.090.12
9,52	40	67	8x20	307.095.11	307.095.12
10	40	67	8x20	307.100.11	307.100.12
12	40	67	8x20	307.120.11	307.120.12

TECHNICAL DETAILS:

- Super-strength steel.
- Cutter portion coated with black or orange P.T.F.E.
- HW head with precision balanced centre point.
- 2 HW precision ground cutting edges [Z2].
- Negatively ground spurs [V2].
- 4 spiral flutes.
- Parallel shank with driving flat and length adjusting screw.

Spare parts



990.003.00

Optional

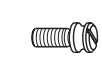

990.088.00

APPLICATION: used on boring machines equipped with adaptors or chucks. Used to drill blind holes in solid wood, wood composites, plastic and laminated materials.

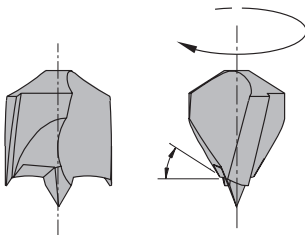

Negatively ground spurs

4 flute dowel drills

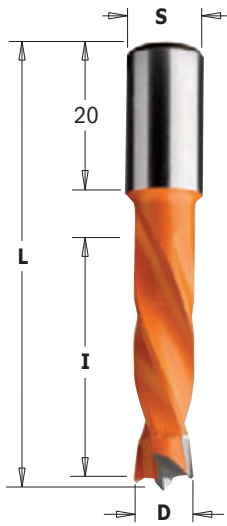

308



D mm	I mm	L mm	S mm	ORDER NO.	ORDER NO.
				Right-hand rotation	Left-hand rotation
4	26	57,5	10x20	308.040.11	308.040.12
5	30	57,5	10x20	308.050.11	308.050.12
6	30	57,5	10x20	308.060.11	308.060.12
6,35	30	57,5	10x20	308.064.11	308.064.12
7	30	57,5	10x20	308.070.11	308.070.12
8	30	57,5	10x20	308.080.11	308.080.12
9	30	57,5	10x20	308.090.11	308.090.12
9,52	30	57,5	10x20	308.095.11	308.095.12
10	30	57,5	10x20	308.100.11	308.100.12
11	30	57,5	10x20	308.110.11	308.110.12
12	30	57,5	10x20	308.120.11	308.120.12
12,7	30	57,5	10x20	308.127.11	308.127.12
13	30	57,5	10x20	308.130.11	308.130.12
14	30	57,5	10x20	308.140.11	308.140.12
15	30	57,5	10x20	308.150.11	308.150.12
16	30	57,5	10x20	308.160.11	308.160.12

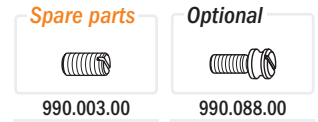

4 flute dowel drills

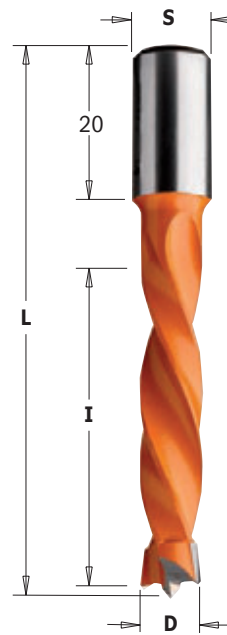

309



D mm	I mm	L mm	S mm	ORDER NO.	ORDER NO.
				Right-hand rotation	Left-hand rotation
4	43	70	10x20	309.040.11	309.040.12
5	43	70	10x20	309.050.11	309.050.12
6	43	70	10x20	309.060.11	309.060.12
6,35	43	70	10x20	309.064.11	309.064.12
7	43	70	10x20	309.070.11	309.070.12
7,5	43	70	10x20	309.075.11	309.075.12
8	43	70	10x20	309.080.11	309.080.12
9	43	70	10x20	309.090.11	309.090.12
9,52	43	70	10x20	309.095.11	309.095.12
10	43	70	10x20	309.100.11	309.100.12
11	43	70	10x20	309.110.11	309.110.12
12	43	70	10x20	309.120.11	309.120.12
12,7	43	70	10x20	309.127.11	309.127.12
13	43	70	10x20	309.130.11	309.130.12
14	43	70	10x20	309.140.11	309.140.12
15	43	70	10x20	309.150.11	309.150.12
16	43	70	10x20	309.160.11	309.160.12

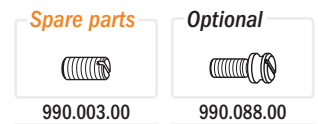

TECHNICAL DETAILS:

- Super-strength steel.
- Cutter portion coated with black or orange P.T.F.E.
- HW head with precision balanced centre point.
- 2 HW precision ground cutting edges [Z2].
- Negatively ground spurs [V2].
- 4 spiral flutes.
- Parallel shank with driving flat and length adjusting screw.

APPLICATION: used on boring machines equipped with adaptors or chucks. Used to drill blind holes in solid wood, wood composites, plastic and laminated materials.

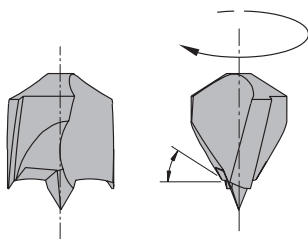

Negatively ground spurs

4 flute dowel drills

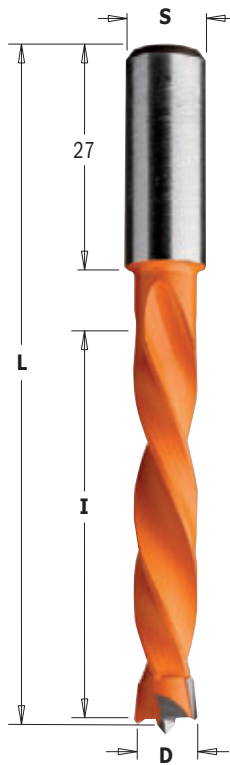

373

HW **Z2** **V2** **RH** **LH**

D mm	I mm	L mm	S mm	ORDER NO. Right-hand rotation	ORDER NO. Left-hand rotation
5	50	85	10x27	373.050.11	373.050.12
6	50	85	10x27	373.060.11	373.060.12
7	50	85	10x27	373.070.11	373.070.12
8	50	85	10x27	373.080.11	373.080.12
10	50	85	10x27	373.100.11	373.100.12
12	50	85	10x27	373.120.11	373.120.12

TECHNICAL DETAILS:

- Super-strength steel.
- Cutter portion coated with black or orange P.T.F.E.
- HW head with precision balanced centre point.
- 2 HW precision ground cutting edges [Z2].
- Negatively ground spurs [V2].
- 4 spiral flutes.
- Parallel shank with driving flat and length adjusting screw.

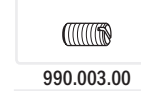
Spare parts

990.003.00

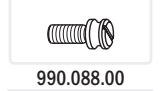
Optional

990.088.00

APPLICATION: used on boring machines equipped with adaptors or chucks. Used to drill blind holes in solid wood, wood composites, plastic and laminated materials.

4 flute dowel drills

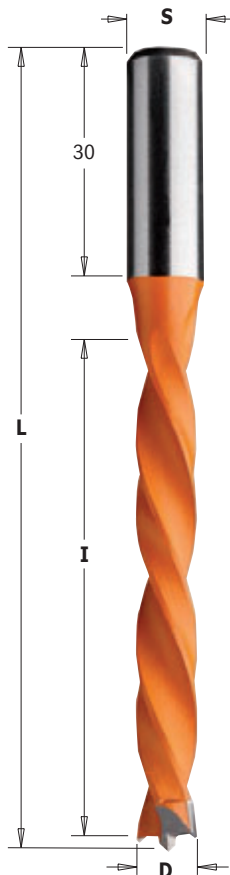

372

HW **Z2** **V2** **RH** **LH**

D mm	I mm	L mm	S mm	ORDER NO. Right-hand rotation	ORDER NO. Left-hand rotation
5	65	105	10x30	372.050.11	372.050.12
6	65	105	10x30	372.060.11	372.060.12
7	65	105	10x30	372.070.11	372.070.12
8	65	105	10x30	372.080.11	372.080.12
10	65	105	10x30	372.100.11	372.100.12
12	65	105	10x30	372.120.11	372.120.12

TECHNICAL DETAILS:

- Super-strength steel.
- Cutter portion coated with black or orange P.T.F.E.
- HW head with precision balanced centre point.
- 2 HW precision ground cutting edges [Z2].
- Negatively ground spurs [V2].
- 4 spiral flutes.
- Parallel shank with driving flat and length adjusting screw.

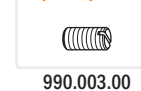
Spare parts

990.003.00

Optional

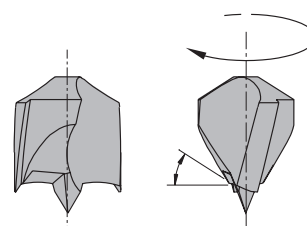

990.088.00

APPLICATION: used on boring machines equipped with adaptors or chucks. Used to drill blind holes in solid wood, wood composites, plastic and laminated materials.

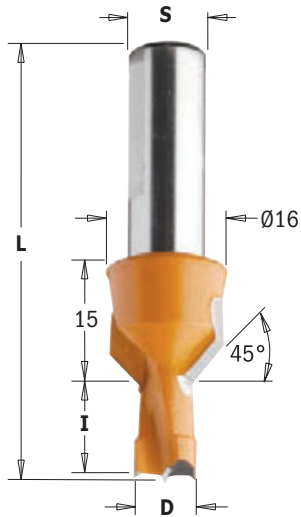

Negatively ground spurs

Dowel drills with countersink



376-377

D mm	I mm	L mm	S mm	ORDER NO.	ORDER NO.
				Right-hand rotation	Left-hand rotation
8	12	57,5	10	376.080.11	376.080.12
8	13	57,5	10	376.083.11	376.083.12
8	15	57,5	10	376.081.11	376.081.12
8	20	57,5	10	376.082.11	376.082.12
10	12	57,5	10	376.100.11	376.100.12
10	13	57,5	10	376.103.11	376.103.12
10	15	57,5	10	376.101.11	376.101.12
10	20	57,5	10	376.102.11	376.102.12
8	12	70	10	377.080.11	377.080.12
8	13	70	10	377.083.11	377.083.12
8	15	70	10	377.081.11	377.081.12
8	20	70	10	377.082.11	377.082.12
10	12	70	10	377.100.11	377.100.12
10	13	70	10	377.103.11	377.103.12
10	15	70	10	377.101.11	377.101.12
10	20	70	10	377.102.11	377.102.12

TECHNICAL DETAILS:

- Super-strength steel.
- Spiral portion coated with orange or black P.T.F.E.
- HW head with precision balanced centre point.
- 2 precision ground cutting edges [Z2].
- 2 ground spurs [V2].
- 2 spiral flutes.
- Parallel shank with driving flat and length adjusting screw.

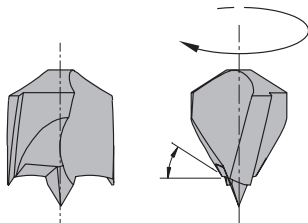
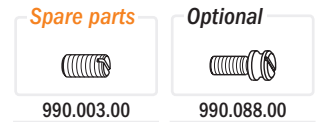

Negatively ground spurs

APPLICATION: used for drilling and countersinking in solid wood, wood composites, plastic and laminated materials. Suitable for high performance speed on boring machines equipped with adaptors or chucks.

Dowel drills for through holes with countersink

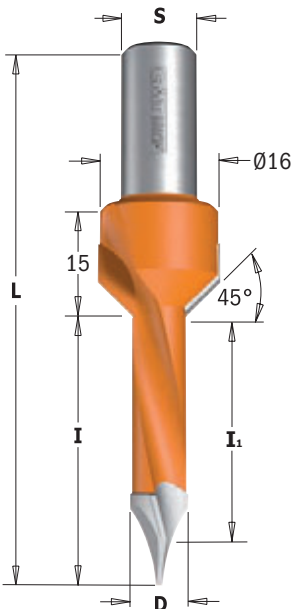

378

D mm	I mm	I ₁ mm	L mm	S mm	ORDER NO.	ORDER NO.
					Right-hand rotation	Left-hand rotation
5	35	31	70	10	378.052.11	378.052.12
7	35	29,5	70	10	378.072.11	378.072.12
8	35	29	70	10	378.082.11	378.082.12
10	35	26,5	70	10	378.102.11	378.102.12

TECHNICAL DETAILS:

- Super-strength steel.
- Spiral portion coated with orange or black P.T.F.E.
- HW head with precision balanced centre point.
- 2 precision ground cutting edges [Z2].
- 2 ground spurs [V2].
- 2 spiral flutes.
- Parallel shank with driving flat and length adjusting screw.

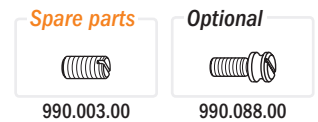

APPLICATION: used for drilling and countersinking in solid wood, wood composites, plastic and laminated materials. Suitable for high performance speed on boring machines equipped with adaptors or chucks.

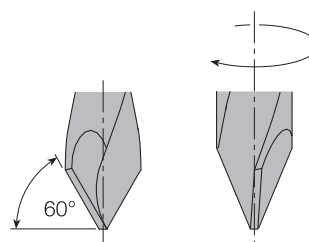

60° through holes

2 flute dowel drills for through holes

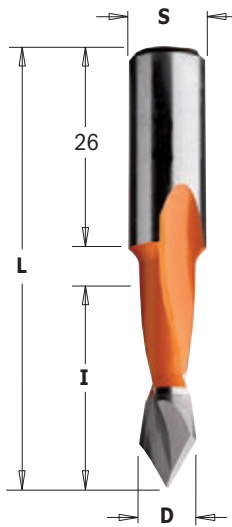

313



D mm	I mm	L mm	S mm	ORDER NO.	ORDER NO.
				Right-hand rotation	Left-hand rotation
5	27	57,5	10x26	313.050.11	313.050.12
6	27	57,5	10x26	313.060.11	313.060.12
8	27	57,5	10x26	313.080.11	313.080.12
10	27	57,5	10x26	313.100.11	313.100.12

For panels with maximum 20mm in thickness.

TECHNICAL DETAILS:

- Super-strength steel.
- Spiral portion coated with orange or black P.T.F.E.
- HW head with precision balanced centre point.
- 2 precision ground cutting edges [Z2].
- 2 spiral flutes.
- Parallel shank with driving flat and length adjusting screw.

Spare parts

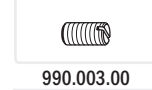

Optional



APPLICATION: used on boring machines and dowel drilling devices.

Use for drilling through holes in solid wood, wood composites, plastic and laminated materials.

2 flute dowel drills for through holes

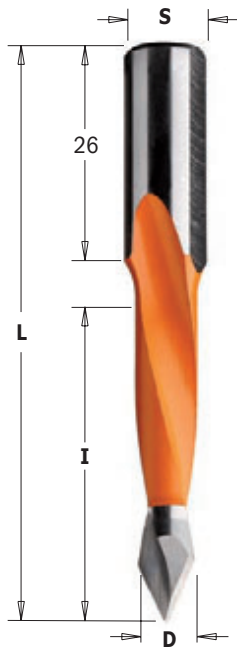

314



D mm	I mm	L mm	S mm	ORDER NO.	ORDER NO.
				Right-hand rotation	Left-hand rotation
4	30	70	10x26	314.040.11	314.040.12
4,76	35	70	10x26	314.047.11	314.047.12
5	35	70	10x26	314.050.11	314.050.12
5,55	35	70	10x26	314.055.11	314.055.12
6	35	70	10x26	314.060.11	314.060.12
6,35	35	70	10x26	314.064.11	314.064.12
7	35	70	10x26	314.070.11	314.070.12
8	35	70	10x26	314.080.11	314.080.12
9	35	70	10x26	314.090.11	314.090.12
9,52	35	70	10x26	314.095.11	314.095.12
10	35	70	10x26	314.100.11	314.100.12
12	35	70	10x26	314.120.11	314.120.12
12,7	35	70	10x26	314.127.11	314.127.12

For panels with maximum 25-30mm in thickness.

366

5	44	77	10x26	366.050.11	366.050.12
6	44	77	10x26	366.060.11	366.060.12
8	44	77	10x26	366.080.11	366.080.12
10	44	77	10x26	366.100.11	366.100.12
12	44	77	10x26	366.120.11	366.120.12

For panels with maximum 30-40mm in thickness.

TECHNICAL DETAILS:

- Super-strength steel.
- Spiral portion coated with orange or black P.T.F.E.
- HW head with precision balanced centre point.
- 2 precision ground cutting edges [Z2].
- 2 spiral flutes.
- Parallel shank with driving flat and length adjusting screw.

Spare parts

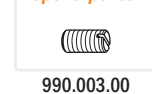

Optional



APPLICATION: used on boring machines and dowel drilling devices.

Use for drilling through holes in solid wood, wood composites, plastic and laminated materials.

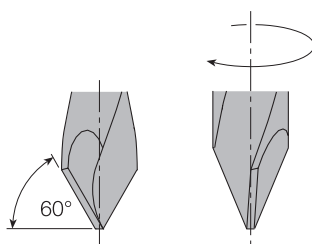

60° through holes

4 flute dowel drills for through holes

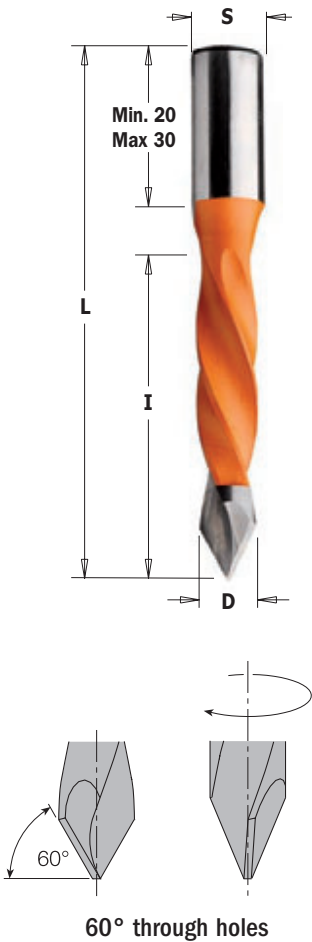

374 For panels with maximum 20-25mm in thickness.



D	I	L	S	ORDER NO.	ORDER NO.
mm	mm	mm	mm	Right-hand rotation	Left-hand rotation
5	30	57,5	10x20	374.050.11	374.050.12
8	30	57,5	10x20	374.080.11	374.080.12

375 For panels with maximum 30-35mm in thickness.

D	I	L	S	ORDER NO.	ORDER NO.
mm	mm	mm	mm	Right-hand rotation	Left-hand rotation
5	40	70	10x20	375.050.11	375.050.12
6	40	70	10x20	375.060.11	375.060.12
7	40	70	10x20	375.070.11	375.070.12
8	40	70	10x20	375.080.11	375.080.12
9	40	70	10x20	375.090.11	375.090.12
10	40	70	10x20	375.100.11	375.100.12

381 For panels with maximum 60-65mm in thickness.

D	I	L	S	ORDER NO.	ORDER NO.
mm	mm	mm	mm	Right-hand rotation	Left-hand rotation
5	70	115	10x30	381.050.11	381.050.12
6	70	115	10x30	381.060.11	381.060.12
8	70	115	10x30	381.080.11	381.080.12
10	70	115	10x30	381.100.11	381.100.12

TECHNICAL DETAILS:

- Super-strength steel
- Spiral portion coated with orange or black P.T.F.E.
- HW head with precision balanced centre point
- 2 precision ground cutting edges [Z2]
- 4 spiral flutes
- Parallel shank with driving flat and length adjusting screw.

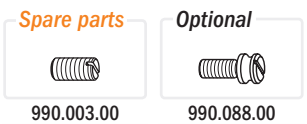

APPLICATION: used on boring machines and dowel drilling devices.

Use for drilling through holes in solid wood, wood composites, plastic and laminated materials.

2 flute dowel drills for through holes

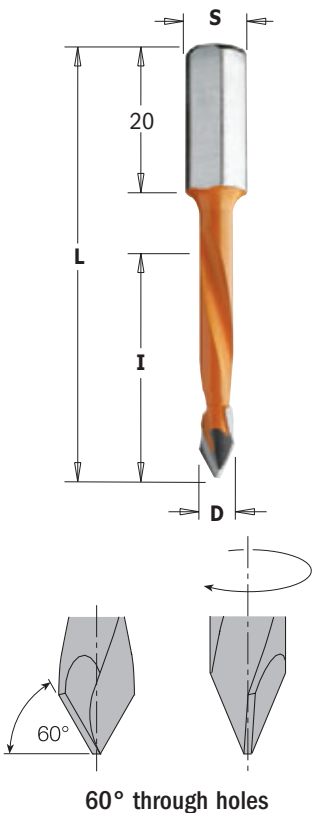

367



D	I	L	S	ORDER NO.	ORDER NO.
mm	mm	mm	mm	Right-hand rotation	Left-hand rotation
5	30	56	8x20	367.050.11	367.050.12
8	30	56	8x20	367.080.11	367.080.12

For panels with maximum 20-25mm in thickness.

368

D	I	L	S	ORDER NO.	ORDER NO.
mm	mm	mm	mm	Right-hand rotation	Left-hand rotation
5	43	70	8x20	368.050.11	368.050.12
6	43	70	8x20	368.060.11	368.060.12
7	43	70	8x20	368.070.11	368.070.12
8	43	70	8x20	368.080.11	368.080.12

For panels with maximum 35-40mm in thickness

TECHNICAL DETAILS:

- Super-strength steel
- Spiral portion coated with orange or black P.T.F.E.
- HW head with precision balanced centre point
- 2 precision ground cutting edges [Z2]
- 2 spiral flutes
- Parallel shank with driving flat and length adjusting screw.

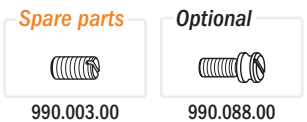

APPLICATION: used on boring machines and dowel drilling devices.

Use for drilling through holes in solid wood, wood composites, plastic and laminated materials.

Countersinks for 2 flutes dowel drills

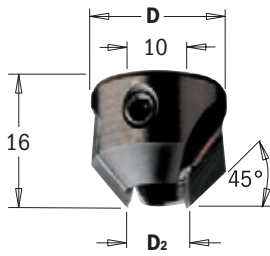

315



D ₂ mm	D mm	ORDER NO. Right-hand rotation	ORDER NO. Left-hand rotation
5 ~ 10	20	315.200.11	315.200.12
11 ~ 12	22	315.220.11	315.220.12

**For assembly on the shank of the drill.
For use with the following parts: 310-311-362-313-314-366 HW**



TECHNICAL DETAILS:
 - Super-strength steel.
 - 2 precision ground carbide tipped cutting edges [Z2].
 - Direct clamp on the shank of the drills.

APPLICATION: used for chamfering and drilling in solid wood, wood composites, plastic and laminated materials.

Countersinks for 4 flutes dowel drills

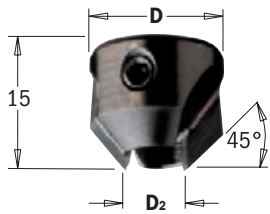

316



D ₂ mm	D mm	ORDER NO. Right-hand rotation	ORDER NO. Left-hand rotation
4	16	316.040.11	316.040.12
5	16	316.050.11	316.050.12
6	16	316.060.11	316.060.12
7	16	316.070.11	316.070.12
8	18	316.080.11	316.080.12
9	18	316.090.11	316.090.12
10	20	316.100.11	316.100.12
12	20	316.120.11	316.120.12

**For assembly on the spiral head of the bit.
Adjustable depth.
For use with the following parts:
306-307-308-309-373-374-375-338-339-
340-341-342-343-344-346-352-353 HW**

TECHNICAL DETAILS:
 - Super-strength steel.
 - 2 HW precision ground cutting edges [Z2].



APPLICATION: used for drilling and chamfering in solid wood, wood composites, plastic and laminated materials.

315 assembly Illustration



316 assembly Illustration



Saw blades
Jig saw blades
Tools with bore & Knives
Router bits & sets
CNC router cutter & chucks
Industrial dowel drills
Bits for hand power tools
Power tools & accessories
Display cabinets & spare parts

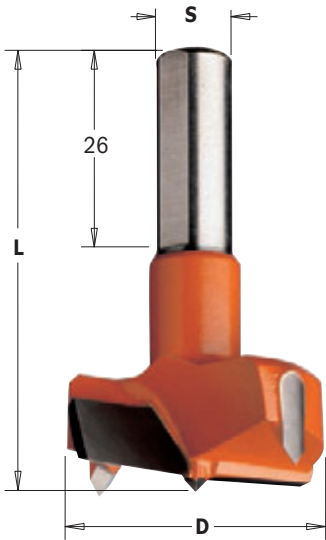

New construction with 1mm centre point

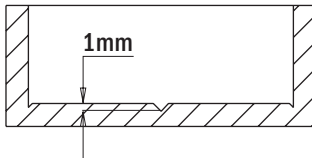

317



D mm	L mm	S mm	ORDER NO.	
			Right-hand rotation	Left-hand rotation
14	57,5	10x26	317.140.11	317.140.12
15	57,5	10x26	317.150.11	317.150.12
16	57,5	10x26	317.160.11	317.160.12
17	57,5	10x26	317.170.11	317.170.12
18	57,5	10x26	317.180.11	317.180.12
19	57,5	10x26	317.190.11	317.190.12
20	57,5	10x26	317.200.11	317.200.12
22	57,5	10x26	317.220.11	317.220.12
24	57,5	10x26	317.240.11	317.240.12
25	57,5	10x26	317.250.11	317.250.12
26	57,5	10x26	317.260.11	317.260.12
28	57,5	10x26	317.280.11	317.280.12
30	57,5	10x26	317.300.11	317.300.12
32	57,5	10x26	317.320.11	317.320.12
34	57,5	10x26	317.340.11	317.340.12
35	57,5	10x26	317.350.11	317.350.12
38	57,5	10x26	317.380.11	317.380.12
40	57,5	10x26	317.400.11	317.400.12
42	57,5	10x26	317.420.11	317.420.12
45	57,5	10x26	317.450.11	317.450.12
50	57,5	10x26	317.500.11	317.500.12
55	57,5	10x26	317.550.11	317.550.12
60	57,5	10x26	317.600.11	317.600.12

TECHNICAL DETAILS:

- Super-strength steel.
- Cutter portion coated with orange or black P.T.F.E.
- HW head with precision balanced centre point.
- 2 HW precision ground cutting edges [Z2].
- 2 negatively ground spurs [V2].
- Parallel shank with driving flat and length adjusting screw.

Spare parts



990.003.00

Optional



990.088.00

APPLICATION: ideal for hinges. Use on boring machines equipped with adaptors or chucks.

Use for drilling accurate and clean-cut blind holes in solid wood, wood composites, plastic and laminated materials.

DP Hinge boring bits

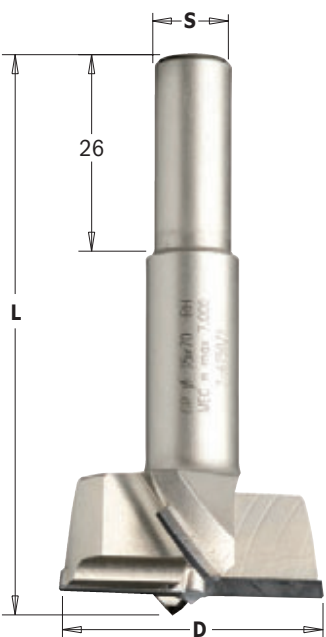

317-369



D mm	L mm	S mm	ORDER NO.	
			Right-hand rotation	Left-hand rotation
15	57,5	10x26	317.150.61	317.150.62
35	57,5	10x26	317.350.61	317.350.62
15	70	10x26	369.150.61	369.150.62
35	70	10x26	369.350.61	369.350.62

TECHNICAL DETAILS:

- Super-strength steel.
- DP head with precision balanced centre point.
- 2 DP precision ground cutting edges [Z2].
- 2 DP negatively ground spurs [V2].
- Parallel shank with driving flat and length adjusting screw.

Spare parts



990.003.00

Optional



990.088.00

APPLICATION: ideal for hinges. Use on boring machines equipped with adaptors or chucks. Use for drilling accurate and clean-cut blind holes in wood composites, plastic and laminated materials. Boring performance 20 times longer than HW materials.

20X
LONGER LIFE
THAN CARBIDE

REMARK: special dimensions available on request.

Hinge boring bits

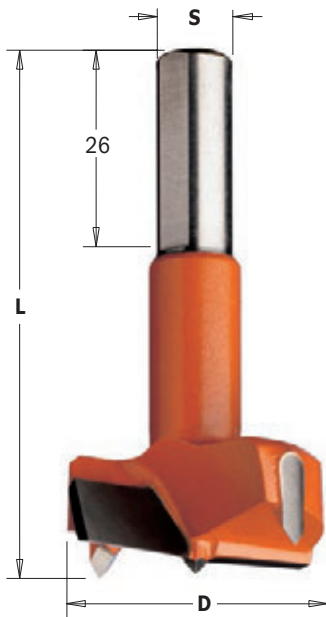
HW **Z2** **V2** **RH** **LH**

369

D mm	L mm	S mm	ORDER NO. Right-hand rotation	ORDER NO. Left-hand rotation
14	70	10x26	369.140.11	369.140.12
15	70	10x26	369.150.11	369.150.12
16	70	10x26	369.160.11	369.160.12
18	70	10x26	369.180.11	369.180.12
20	70	10x26	369.200.11	369.200.12
22	70	10x26	369.220.11	369.220.12
25	70	10x26	369.250.11	369.250.12
26	70	10x26	369.260.11	369.260.12
30	70	10x26	369.300.11	369.300.12
35	70	10x26	369.350.11	369.350.12
40	70	10x26	369.400.11	369.400.12
45	70	10x26	369.450.11	369.450.12
50	70	10x26	369.500.11	369.500.12
55	70	10x26	369.550.11	369.550.12
60	70	10x26	369.600.11	369.600.12

370

D mm	L mm	S mm	ORDER NO. Right-hand rotation	ORDER NO. Left-hand rotation
18	77	10x30	370.180.11	370.180.12
20	77	10x30	370.200.11	370.200.12
25	77	10x30	370.250.11	370.250.12
30	77	10x30	370.300.11	370.300.12
35	77	10x30	370.350.11	370.350.12

New construction with
1mm centre point

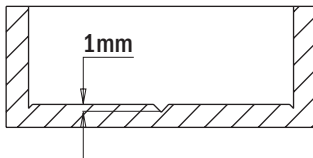

TECHNICAL DETAILS:

- Super-strength steel.
- Cutter portion coated with orange or black P.T.F.E.
- HW head with precision balanced centre point.
- 2 HW precision ground cutting edges [Z2].
- 2 negatively ground spurs [V2].
- Parallel shank with driving flat and length adjusting screw.

Spare parts

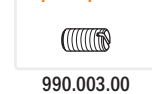

Optional



APPLICATION: ideal for hinges. Use on boring machines equipped with adaptors or chucks.

Use for drilling accurate and clean-cut blind holes in solid wood, wood composites, plastic and laminated materials.

Hinge boring bits with chipbreaker for boring machines

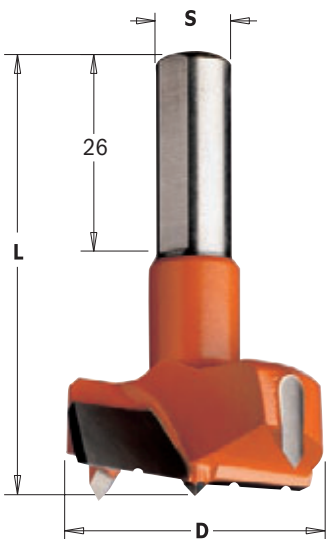
new
HW **Z2R** **V2** **RH** **LH**

317C - 369C

D mm	L mm	S mm	ORDER NO. Right-hand rotation	ORDER NO. Left-hand rotation
35	57,5	10x26	317.350.11C	317.350.12C
40	57,5	10x26	317.400.11C	317.400.12C
45	57,5	10x26	317.450.11C	317.450.12C
35	70	10x26	369.350.11C	369.350.12C
40	70	10x26	369.400.11C	369.400.12C
45	70	10x26	369.450.11C	369.450.12C

TECHNICAL DETAILS:

- Super-strength steel.
- Cutter portion coated with orange or black P.T.F.E.
- HW head with precision balanced centre point.
- 2 HW precision ground cutting edges with chipbreaker [Z2R].
- 2 negatively ground spurs [V2].
- Parallel shank with driving flat and length adjusting screw.

Spare parts

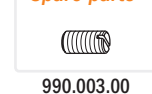

Optional



APPLICATION:

Ideal for hinges. Used on boring machines equipped with adaptors or chucks. For drilling accurate and clean-cut blind holes in solid wood.

Dowel drills with threaded shank



344



D mm	I mm	LB mm	S mm	ORDER NO.	
				Right-hand rotation	Left-hand rotation
5	43	63	M8	344.050.11	344.050.12
6	43	63	M8	344.060.11	344.060.12
8	43	63	M8	344.080.11	344.080.12
10	43	63	M8	344.100.11	344.100.12
12	43	63	M8	344.120.11	344.120.12

FOR USE ON THE FOLLOWING MACHINES:
Nottmeyer (older models)

346



D mm	I mm	LB mm	S mm	ORDER NO.	
				Right-hand rotation	Left-hand rotation
5	43	63	M10	346.050.11	346.050.12
6	43	63	M10	346.060.11	346.060.12
8	43	63	M10	346.080.11	346.080.12
10	43	63	M10	346.100.11	346.100.12
12	43	63	M10	346.120.11	346.120.12

FOR USE ON THE FOLLOWING MACHINES:
Ayen, Holzma, Knoevenagel, Mayer, Torwegge.

TECHNICAL DETAILS:

- Super-strength steel.
- HW head with precision balanced centre point.
- 2 precision ground cutting edges [Z2].
- 2 ground spurs [V2].
- 4 spiral flutes.

APPLICATION: used on boring machines equipped with chucks.
Used to drill blind holes in solid wood, wood composites, plastic and laminated materials.

Dowel drills with threaded shank

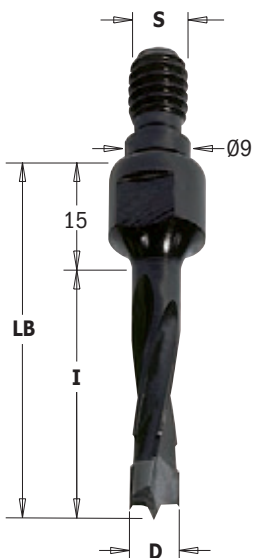

352-353



D mm	I mm	LB mm	S mm	ORDER NO.	
				Right-hand rotation	Left-hand rotation
5	30	45	M8/9	352.050.11	352.050.12
6	30	45	M8/9	352.060.11	352.060.12
8	30	45	M8/9	352.080.11	352.080.12
10	30	45	M8/9	352.100.11	352.100.12
12	30	45	M8/9	352.120.11	352.120.12
5	40	55	M8/9	353.050.11	353.050.12
6	40	55	M8/9	353.060.11	353.060.12
8	40	55	M8/9	353.080.11	353.080.12
10	40	55	M8/9	353.100.11	353.100.12
12	40	55	M8/9	353.120.11	353.120.12

FOR USE ON THE FOLLOWING MACHINES:
Masterwood (Zangheri & Boschetti)
Morbidelli, Nottmeyer (new design)

TECHNICAL DETAILS:

- Super-strength steel.
- HW head with precision balanced centre point.
- 2 precision ground cutting edges [Z2].
- 2 ground spurs [V2].
- 4 spiral flutes.

APPLICATION: used on boring machines equipped with chucks.
Used to drill blind holes in solid wood, wood composites, plastic and laminated materials.

Dowel drills with threaded shank with countersink

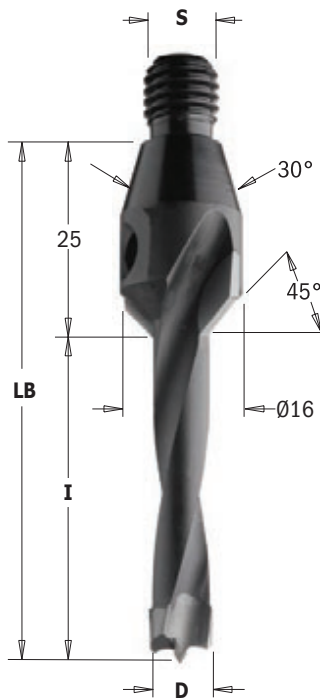

332-334-336-337



D mm	I mm	LB mm	S mm	ORDER NO.	
				Right-hand rotation	Left-hand rotation
5	20	45	M10/30°	332.050.11	332.050.12
6	20	45	M10/30°	332.060.11	332.060.12
8	20	45	M10/30°	332.080.11	332.080.12
10	20	45	M10/30°	332.100.11	332.100.12
12	20	45	M10/30°	332.120.11	332.120.12
5	30	55	M10/30°	334.050.11	334.050.12
6	30	55	M10/30°	334.060.11	334.060.12
8	30	55	M10/30°	334.080.11	334.080.12
10	30	55	M10/30°	334.100.11	334.100.12
12	30	55	M10/30°	334.120.11	334.120.12
5	40	65	M10/30°	336.050.11	336.050.12
6	40	65	M10/30°	336.060.11	336.060.12
8	40	65	M10/30°	336.080.11	336.080.12
10	40	65	M10/30°	336.100.11	336.100.12
12	40	65	M10/30°	336.120.11	336.120.12
5	50	75	M10/30°	337.050.11	337.050.12
6	50	75	M10/30°	337.060.11	337.060.12
8	50	75	M10/30°	337.080.11	337.080.12
10	50	75	M10/30°	337.100.11	337.100.12
12	50	75	M10/30°	337.120.11	337.120.12

TECHNICAL DETAILS:

- Super-strength steel.
- HW head with precision balanced centre point.
- 2 precision ground cutting edge [Z2].
- 2 ground spurts [V2].
- 2 spiral flutes.

APPLICATION: used on boring machines equipped with chucks.

Used to drill blind holes in solid wood, wood composites, plastic and laminated materials.

Dowel drills with threaded shank without countersink



341-342-343



D mm	I mm	LB mm	S mm	ORDER NO.	
				Right-hand rotation	Left-hand rotation
5	30	55	M10/30°	341.050.11	341.050.12
6	30	55	M10/30°	341.060.11	341.060.12
8	30	55	M10/30°	341.080.11	341.080.12
10	30	55	M10/30°	341.100.11	341.100.12
12	30	55	M10/30°	341.120.11	341.120.12
5	40	65	M10/30°	342.050.11	342.050.12
6	40	65	M10/30°	342.060.11	342.060.12
8	40	65	M10/30°	342.080.11	342.080.12
10	40	65	M10/30°	342.100.11	342.100.12
12	40	65	M10/30°	342.120.11	342.120.12
5	50	75	M10/30°	343.050.11	343.050.12
6	50	75	M10/30°	343.060.11	343.060.12
8	50	75	M10/30°	343.080.11	343.080.12
10	50	75	M10/30°	343.100.11	343.100.12
12	50	75	M10/30°	343.120.11	343.120.12

TECHNICAL DETAILS:

- Super-strength steel.
- HW head with precision balanced centre point.
- 2 precision ground cutting edges [Z2].
- 2 ground spurts [V2].
- 4 spiral flutes.

APPLICATION: used on boring machines equipped with chucks.

Used to drill blind holes in solid wood, wood composites, plastic and laminated materials.

Dowel drills with threaded shank with countersink

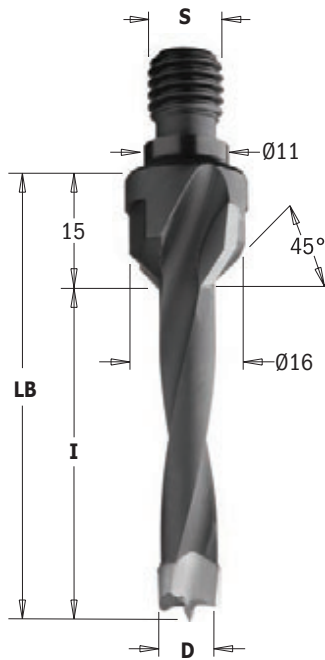

325-327-329-330



D mm	I mm	LB mm	S mm	ORDER NO.	
				Right-hand rotation	Left-hand rotation
5	20	35	M10/11x4	325.050.11	325.050.12
6	20	35	M10/11x4	325.060.11	325.060.12
8	20	35	M10/11x4	325.080.11	325.080.12
10	20	35	M10/11x4	325.100.11	325.100.12
12	20	35	M10/11x4	325.120.11	325.120.12
5	30	45	M10/11x4	327.050.11	327.050.12
6	30	45	M10/11x4	327.060.11	327.060.12
8	30	45	M10/11x4	327.080.11	327.080.12
10	30	45	M10/11x4	327.100.11	327.100.12
12	30	45	M10/11x4	327.120.11	327.120.12
5	40	55	M10/11x4	329.050.11	329.050.12
6	40	55	M10/11x4	329.060.11	329.060.12
8	40	55	M10/11x4	329.080.11	329.080.12
10	40	55	M10/11x4	329.100.11	329.100.12
12	40	55	M10/11x4	329.120.11	329.120.12
5	50	65	M10/11x4	330.050.11	330.050.12
6	50	65	M10/11x4	330.060.11	330.060.12
8	50	65	M10/11x4	330.080.11	330.080.12
10	50	65	M10/11x4	330.100.11	330.100.12
12	50	65	M10/11x4	330.120.11	330.120.12

TECHNICAL DETAILS:

- Super-strength steel.
- HW head with precision balanced centre point.
- 2 precision ground cutting edges [Z2].
- 2 spiral flutes.
- 2 ground spurs [V2].

APPLICATION:

used on boring machines equipped with chucks. Used to drill blind holes in solid wood, wood composites, plastic and laminated materials.

Dowel drills with threaded shank without countersink



338-339-340



D mm	I mm	LB mm	S mm	ORDER NO.	
				Right-hand rotation	Left-hand rotation
5	30	45	M10/11x4	338.050.11	338.050.12
6	30	45	M10/11x4	338.060.11	338.060.12
8	30	45	M10/11x4	338.080.11	338.080.12
10	30	45	M10/11x4	338.100.11	338.100.12
12	30	45	M10/11x4	338.120.11	338.120.12
5	40	55	M10/11x4	339.050.11	339.050.12
6	40	55	M10/11x4	339.060.11	339.060.12
8	40	55	M10/11x4	339.080.11	339.080.12
10	40	55	M10/11x4	339.100.11	339.100.12
12	40	55	M10/11x4	339.120.11	339.120.12
5	50	65	M10/11x4	340.050.11	340.050.12
6	50	65	M10/11x4	340.060.11	340.060.12
8	50	65	M10/11x4	340.080.11	340.080.12
10	50	65	M10/11x4	340.100.11	340.100.12
12	50	65	M10/11x4	340.120.11	340.120.12

TECHNICAL DETAILS:

- Super-strength steel.
- HW head with precision balanced centre point.
- 2 precision ground cutting edges [Z2].
- 2 ground spurs [V2].
- 4 spiral flutes.

APPLICATION:

used on boring machines equipped with chucks. Used to drill blind holes in solid wood, wood composites, plastic and laminated materials.

Special dowel drills

TOOL FEATURES

TOOL MATERIAL

- HW SP steel

QUANTITY AND ROTATION

Nr. RH Bits Nr. LH Bits

SHANK

- PARALLEL SHANK WITH DRIVING FLAT

- Ø8x20mm with driving flat and length adjusting screw
 Ø10x20mm with driving flat and length adjusting screw

- THREADED SHANK

- M8
 M10
 M8 with seating Ø9x4mm
 M10 with seating Ø11x4mm
 M 8 with 20° 48' centring cone
 M10 with 30° centring cone

- PARALLEL SHANK

- S x A =
(Specify diameter and shank length)
-
(Specify other shank types)

HOLE FEATURES

HOLE TO PRODUCE

- Drawing 1 - Blind hole with more than one diameter
 Drawing 2 - Blind hole with counter
 Drawing 3 - Through hole with more than one diameter
 Drawing 4 - Through hole with countersink

DIMENSIONS

d x C
(Specify diameter and depth of first hole)

D x B
(Specify diameter and depth of second hole)

(Specify countersink-angle) "standard 45°"

WORK MATERIAL

- Solid wood
 MDF/Melamine panels
 Chipboard panels and hardwood

(Specify other materials)

MACHINE DATA

Manufacturer/Model

RPM

Feed speed (metres/minute)

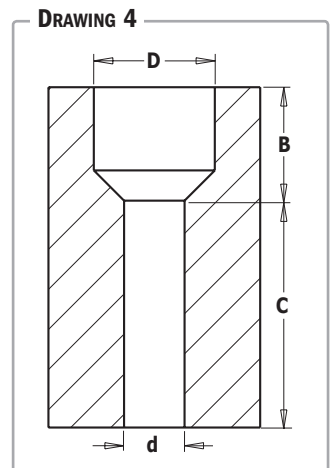
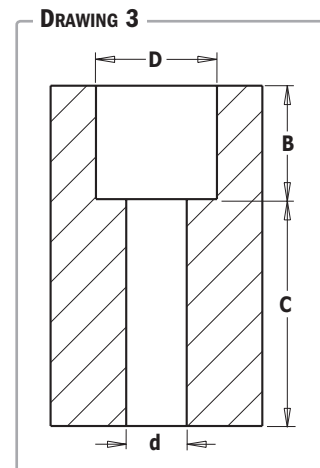
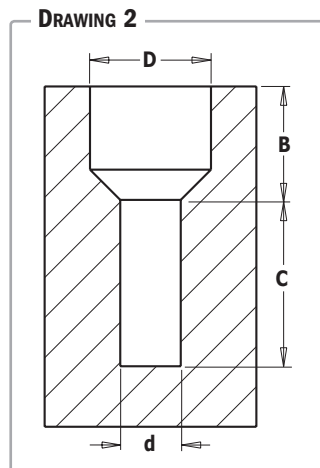
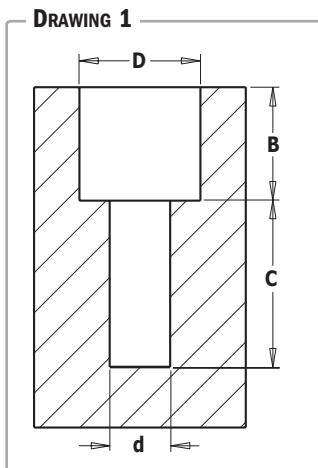

For orders, please fill out this form and fax it to:

#39 0721 481021 or mail to:

C.M.T. Utensili S.p.A. - Via della Meccanica, s.n. - 61122 Pesaro, Fraz. Chiusa di Ginestreto - Italia

Saw blades
 Jig saw blades
 Tools with bore & Knives
 Router bits & sets
 CNC router cutter & chucks
 Industrial dowel drills
 Bits for hand power tools
 Power tools & accessories
 Display cabinets & spare parts



Bits for hand power tools

PRODUCTS	PAGE
Adaptors	252 - 253
Interchangeable boring bits	253
Boring bits	254 ~ 257
Chisel and bit sets	257
Plug cutters & sets	258 - 259
Forstner bits	260
Rosette cutters	261
Brad point bits	262 ~ 265
Bits for Mafell® and Festool® machines	263
Countersinks & drills	266 - 268

Adaptors

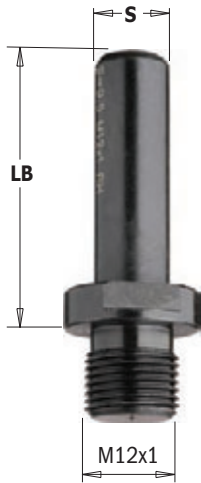

509-532-533 ...with parallel shank for interchangeable bits

RH **LH**

S mm	LB mm	ORDER NO. Right-hand rotation	ORDER NO. Left-hand rotation
8x30	35	532.080.01	
9,5x30	35	532.095.01	
10x50	60	533.100.01	533.100.02
12x30	35	532.120.01	
13x50	100	509.130.01	509.130.02
16x50	100	509.160.01	509.160.02

TECHNICAL DETAILS:

- Super strength steel.
- Parallel shank with driving flat and adjustable screw length.

APPLICATION: used on boring machines with adaptor chucks.

Adaptors

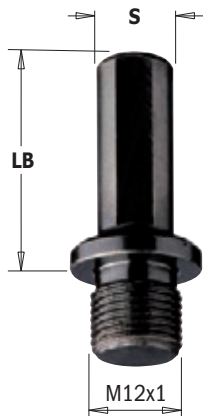

511 ...with parallel shank for quick change drills

RH **LH**

S mm	LB mm	ORDER NO. Right-hand rotation	ORDER NO. Left-hand rotation
10x20 (with driving flat and screw)	27	511.270.01	511.270.02
10x35 (with driving flat and screw)	40	511.400.01	511.400.02

For use with the following parts: 501 HW
TECHNICAL DETAILS:

- Super strength steel.
- Parallel shank with driving flat and adjustable screw length.

APPLICATION: used on boring machines with adaptor chucks.

Spare parts

990.003.00

Adaptors

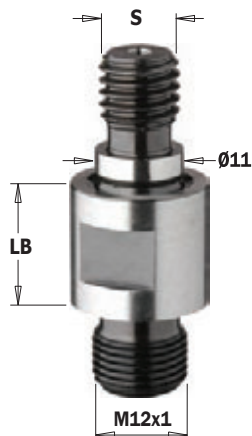

506

RH **LH**

S mm	LB mm	ORDER NO. Right-hand rotation	ORDER NO. Left-hand rotation
M10/11x4	15	506.150.01	506.150.02
M10/11x4	25	506.250.01	506.250.02
M10/11x4	35	506.350.01	506.350.02

For use with the following parts: 501 HW
TECHNICAL DETAILS:

- Super strength steel.
- Parallel shank with driving flat and adjustable screw length.

APPLICATION: used on boring machines with adaptor chucks.



503

RH LH

S mm	LB mm	ORDER NO. Right-hand rotation	ORDER NO. Left-hand rotation
M10/30°	25	503.250.01	503.250.02
M10/30°	35	503.350.01	503.350.02
M10/30°	45	503.450.01	503.450.02

For use with the following parts: 501 HW

TECHNICAL DETAILS:

- Super strength steel.
- Parallel shank with driving flat and adjustable screw length

APPLICATION: used on boring machines with adaptor chucks.



534

RH

S	ORDER NO. Right-hand rotation
MK2/Ø20x14F.x1"	534.020.01
MK2/M30x1,5	534.030.01

For use with the following parts: 501 HW

TECHNICAL DETAILS:

- Super strength steel.

APPLICATION: used on CNC machines or hand-held routers equipped with adaptor chucks.

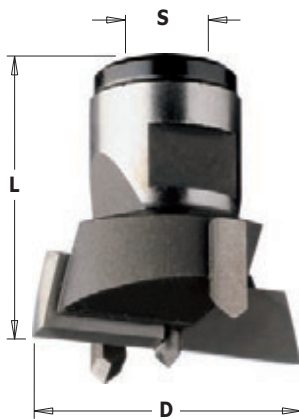

501

HW Z2+2 RH LH

D mm	L mm	S mm	ORDER NO. Right-hand rotation	ORDER NO. Left-hand rotation
20	30	M12x1	501.200.11	501.200.12
22	30	M12x1	501.220.11	501.220.12
24	30	M12x1	501.240.11	501.240.12
25	30	M12x1	501.250.11	501.250.12
26	30	M12x1	501.260.11	501.260.12
30	30	M12x1	501.300.11	501.300.12
32	30	M12x1	501.320.11	501.320.12
34	30	M12x1	501.340.11	501.340.12
35	30	M12x1	501.350.11	501.350.12
36	30	M12x1	501.360.11	501.360.12
38	30	M12x1	501.380.11	501.380.12
40	30	M12x1	501.400.11	501.400.12
45	30	M12x1	501.450.11	501.450.12
50	30	M12x1	501.500.11	501.500.12
55	30	M12x1	501.550.11	501.550.12
60	30	M12x1	501.600.11	501.600.12

Boring bits with parallel shank

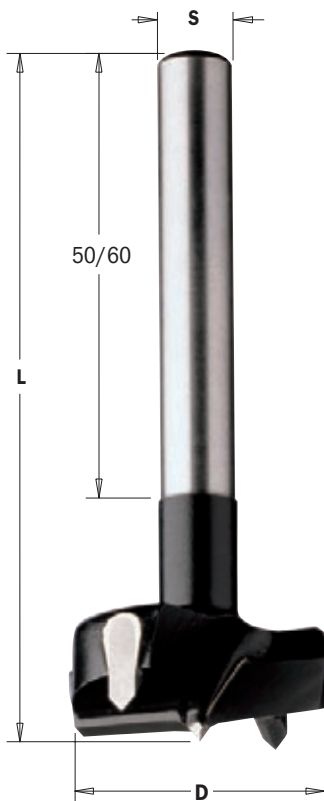
HW **Z2** **V2** **RH**

512

D mm	L mm	S mm	ORDER NO. Right-hand rotation
14	90	10x60	512.140.11
15	90	10x60	512.150.11
16	90	10x60	512.160.11
17	90	10x60	512.170.11
18	90	10x60	512.180.11
19	90	10x60	512.190.11
20	90	10x60	512.200.11
21	90	10x60	512.210.11
22	90	10x60	512.220.11
23	90	10x60	512.230.11
24	90	10x60	512.240.11
25	90	10x60	512.250.11
26	90	10x60	512.260.11
27	90	10x60	512.270.11
28	90	10x60	512.280.11
29	90	10x60	512.290.11
30	90	10x60	512.300.11
31	90	10x60	512.310.11
32	90	10x60	512.320.11
33	90	10x60	512.330.11
34	90	10x60	512.340.11
35	90	10x60	512.350.11
38	90	10x60	512.380.11
40	90	10x60	512.400.11
45	90	10x50	512.450.11
48	90	10x50	512.480.11
50	90	10x50	512.500.11
55	90	10x50	512.550.11
58	90	10x50	512.580.11
60	90	10x50	512.600.11

TECHNICAL DETAILS:

- Super strength steel.
- HW precision balanced centre point.
- 2 HW precision ground cutting edges [Z2].
- 2 HW negatively ground spurs [V2].
- Parallel shank.

APPLICATION: used for drilling blind holes in solid wood, wood composites and plastic laminate materials. Ideal for hinges.

5 piece boring bit set for hinges

HW **Z2** **V2** **RH**

512

The perfect set for hinge work and other related applications. Machined from special high speed steel with micrograin carbide tips, these bits are available in diameters of 15, 20, 25, 30 and 35mm. Safely packaged in a solid plastic box with glass front for easy storage and inventory.

TECHNICAL DETAILS:

- Super strength steel.
- HW precision balanced centre point.
- 2 HW precision ground cutting edges [Z2].
- 2 HW negatively ground spurs [V2].
- Parallel shank.

APPLICATION: used for drilling blind holes in solid wood, wood composites and plastic laminated materials. **Ideal for hinges.**

DESCRIPTION	S mm	L mm	BIT DIAMETER mm	ORDER NO. Right-hand rotation
5 piece boring bit set for hinges	10	90	15-20-25-30-35	512.001.01

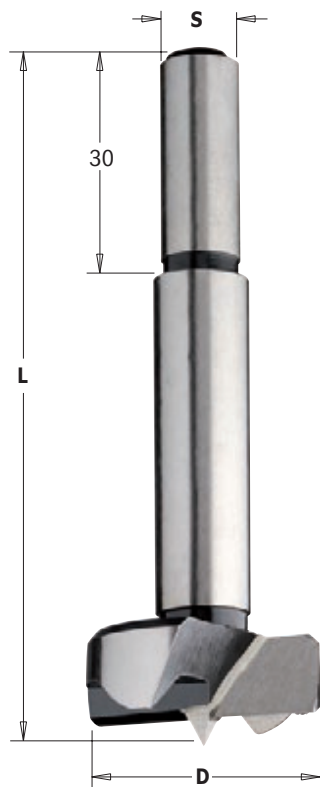

512

SP Z2 V2 RH

D mm	L mm	S mm	ORDER NO. Right-hand rotation
8	90	10x30	512.081.31
10	90	10x30	512.101.31
12	90	10x30	512.121.31
14	90	10x30	512.141.31
15	90	10x30	512.151.31
16	90	10x30	512.161.31
18	90	10x30	512.181.31
20	90	10x30	512.201.31
22	90	10x30	512.221.31
24	90	10x30	512.241.31
25	90	10x30	512.251.31
26	90	10x30	512.261.31
28	90	10x30	512.281.31
30	90	10x30	512.301.31
32	90	10x30	512.321.31
34	90	10x30	512.341.31
35	90	10x30	512.351.31
38	90	10x30	512.381.31
40	90	10x30	512.401.31
45	90	10x30	512.451.31
50	90	10x30	512.501.31

TECHNICAL DETAILS:

- SP steel.
- Precision balanced centre point.
- 2 spurs [V2].
- 2 precision ground cutting edges [Z2].
- Long-lasting cutting performance.
- Parallel shank.

APPLICATION: used for drilling blind holes in softwood. **Ideal for hinges.**

5 piece boring bit set for hinges



512

SP Z2 V2 RH

The perfect set for hinge work and other related applications. Machined from special high speed steel, these bits are available in diameters of 15, 20, 25, 30 and 35mm. Precisely ground, sharpened with round shanks and safely packaged in a solid plastic box with glass front for easy storage and inventory.

TECHNICAL DETAILS:

- SP steel.
- Precision balanced centre point.
- 2 spurs [V2].
- 2 precision ground cutting edges [Z2].
- Long-lasting cutting performance.

APPLICATION: used for drilling blind holes in softwood. **Ideal for hinges.**

DESCRIPTION	S mm	L mm	BIT DIAMETER mm	ORDER NO. Right-hand rotation
5 piece boring bit set for hinges	10	90	15-20-25-30-35	512.001.00

Boring bits with parallel shank

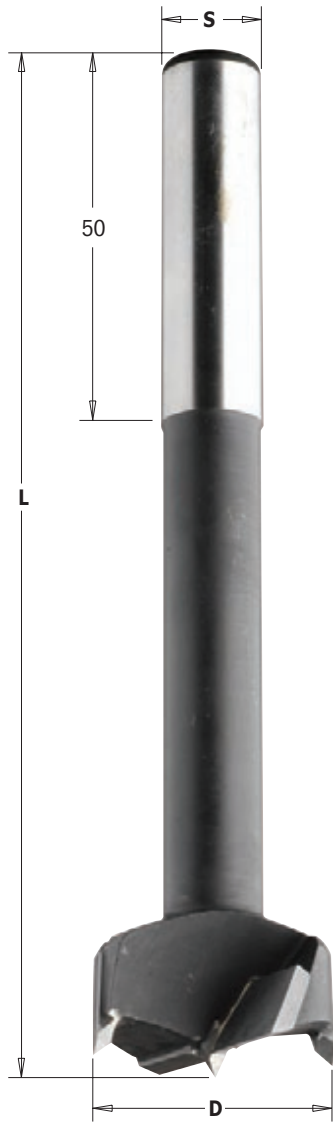
HW **Z2** **V2** **RH**

513

D mm	L mm	S mm	ORDER NO. Right-hand rotation
15	120	13	513.150.11
16	120	13	513.160.11
18	120	13	513.180.11
20	120	13	513.200.11
22	125	13	513.220.11
25	125	13	513.250.11
26	125	13	513.260.11
28	130	13	513.280.11
30	130	13	513.300.11
35	130	13	513.350.11
40	130	13	513.400.11
45	130	13	513.450.11
50	130	13	513.500.11
55	140	13	513.550.11
60	140	13	513.600.11

514

D mm	L mm	S mm	ORDER NO. Right-hand rotation
15	120	16	514.150.11
16	120	16	514.160.11
18	120	16	514.180.11
20	120	16	514.200.11
22	125	16	514.220.11
25	125	16	514.250.11
26	125	16	514.260.11
28	130	16	514.280.11
30	130	16	514.300.11
32	130	16	514.320.11
35	130	16	514.350.11
40	130	16	514.400.11
45	130	16	514.450.11
50	130	16	514.500.11
55	140	16	514.550.11
60	140	16	514.600.11

TECHNICAL DETAILS:

- Super strength steel.
- HW precision balanced centre point.
- 2 HW precision ground cutting edges [Z2].
- 2 HW negatively ground spurs [V2].
- Parallel shank.

APPLICATION: used for drilling blind holes in solid wood, wood composites and plastic laminated materials.
Ideal for hinges.

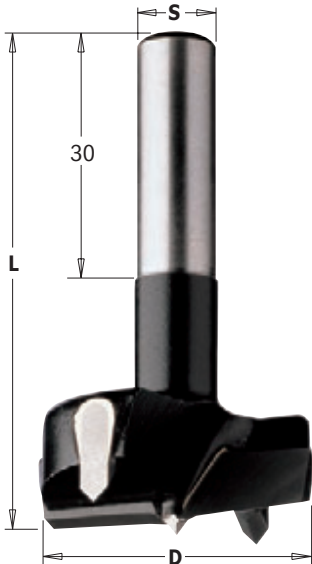

392



D	L	S	ORDER NO.
mm	mm	mm	Right-hand rotation
15	60	8	392.150.11
20	60	8	392.200.11
25	60	8	392.250.11
26	60	8	392.260.11
30	60	8	392.300.11
35	60	8	392.350.11
35	60	12,7	392.351.11
40	60	8	392.400.11

TECHNICAL DETAILS:

- Super strength steel.
- HW precision balanced centre point.
- 2 HW precision ground cutting edges [Z2].
- 2 HW negatively ground spurs [V2].
- Parallel shank.
- Right-hand rotation (RH).

APPLICATION: for use on drilling machines and hand-held routers in solid wood, wood composites and plastic laminated materials. **Ideal for hinges and blind holes.**

Mortise chisel & bit sets



543



D		S		ORDER NO.
mm	inches	mm	inches	Right-hand rotation
6,35	1/4	19	3/4	543.064.51
8	5/16	19	3/4	543.079.51
9,5	3/8	19	3/4	543.095.51
12,7	1/2	19	3/4	543.127.51
15,8	5/8	19	3/4	543.158.51
19	3/4	19	3/4	543.190.51

It's tough to beat the "old faithful" mortise and tenon joint for strength and accuracy, even with all the other joining options in the world of woodworking.

It isn't the easiest joint to make, but for sure it helps have the best quality tools in your shop. That's why we've added a new selection of chisel and bit sets in all the popular sizes 6,35mm (1/4") to 19mm (3/4") diameter.

These sets are for use on any standard drill press mortising attachment of mortising machines.

Plug cutters

529
SP RH

d mm	D mm	L mm	S mm	Z	ORDER NO. Right-hand rotation
8	18	140	13	4	529.080.31
10	20	140	13	4	529.100.31
12	24	140	13	4	529.120.31
14	26	140	13	4	529.140.31
15	27	140	13	4	529.150.31
16	28	140	13	4	529.160.31
18	30	140	13	4	529.180.31
20	32	140	13	4	529.200.31
22	34	140	13	5	529.220.31
25	37	140	13	5	529.250.31
30	42	140	13	5	529.300.31
32	44	160	16	5	529.320.31
35	47	160	16	6	529.350.31
40	52	160	16	6	529.400.31
45	57	160	16	6	529.450.31
50	62	160	16	6	529.500.31

d inches	D inches	L inches	S inches	Z	ORDER NO. Right-hand rotation
3/8	49/64	5-1/2	1/2	4	529.095.31
1/2	61/64	5-1/2	1/2	4	529.127.31
5/8	1-7/64	5-1/2	1/2	4	529.158.31
3/4	1-7/32	5-1/2	1/2	4	529.191.31
7/8	1-11/32	5-1/2	1/2	4	529.222.31
1	1-15/32	5-1/2	1/2	5	529.254.31
1-1/4	1-19/32	5-1/2	1/2	5	529.317.31
1-3/8	1-27/32	6-5/16	5/8	6	529.349.31
1-1/2	1-31/32	6-5/16	5/8	6	529.381.31
1-5/8	2-3/32	6-5/16	5/8	6	529.413.31
1-3/4	2-7/32	6-5/16	5/8	6	529.445.31
2	2-15/32	6-5/16	5/8	6	529.508.31

Use our reduction bushing D=16mm to increase the 13mm shank (order no.799.130.00 page 253)

D mm	D inches	Max RPM Softwood	Max RPM Hardwood
< Ø16	5/8	1000	500
< Ø40	1-37/64	500	300
> Ø40	1-37/64	200	150

TECHNICAL DETAILS:

- SP steel.
- Long lasting cutter performance.

APPLICATION: used to make plugs in hard and soft woods.

Plug cutters

530
HS Z4 RH

D mm	S	ORDER NO. Right-hand rotation
6,2	Ø21x14F.1"	530.062.51
8	Ø21x14F.1"	530.080.51
8,2	Ø21x14F.1"	530.082.51
10	Ø21x14F.1"	530.100.51
10,2	Ø21x14F.1"	530.102.51
12	Ø21x14F.1"	530.120.51
12,2	Ø21x14F.1"	530.122.51

TECHNICAL DETAILS:

- Super strength HS steel.
- 4 precision ground cutting edges [Z4].
- Long lasting cutter performance.

APPLICATION: used for cutting dowels.

REMARK: available on request.

500.001/02/03

SP RH

We offer a wide range of boring bits and plug cutters in the most popular diametres. If you need to bore or to make plugs in softwood these sets are with you need!

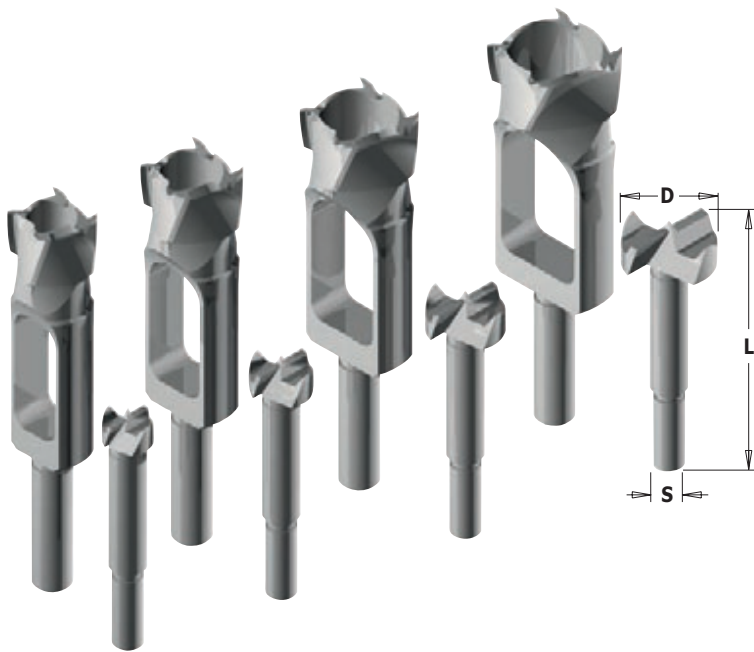

500.001.08 Boring bit & plug cutter set

SET CONTAINS	D mm	L mm	S mm	ORDER NO. Right-hand rotation
Boring bit with parallel shank	8	90	10	512.081.31
Boring bit with parallel shank	10	90	10	512.101.31
Boring bit with parallel shank	12	90	10	512.121.31
Boring bit with parallel shank	15	90	10	512.151.31
Plug cutter	8	140	13	529.080.31
Plug cutter	10	140	13	529.100.31
Plug cutter	12	140	13	529.120.31
Plug cutter	15	140	13	529.150.31

500.002.08 Boring bit & plug cutter set

SET CONTAINS	D mm	L mm	S mm	ORDER NO. Right-hand rotation
Boring bit with parallel shank	16	90	10	512.161.31
Boring bit with parallel shank	20	90	10	512.201.31
Boring bit with parallel shank	25	90	10	512.251.31
Boring bit with parallel shank	30	90	10	512.301.31
Plug cutter	16	140	13	529.160.31
Plug cutter	20	140	13	529.200.31
Plug cutter	25	140	13	529.250.31
Plug cutter	30	140	13	529.300.31

500.003.08 Boring bit & plug cutter set

SET CONTAINS	D mm	L mm	S mm	ORDER NO. Right-hand rotation
Boring bit with parallel shank	15	90	10	512.151.31
Boring bit with parallel shank	20	90	10	512.201.31
Boring bit with parallel shank	25	90	10	512.251.31
Boring bit with parallel shank	30	90	10	512.301.31
Plug cutter	15	140	13	529.150.31
Plug cutter	20	140	13	529.200.31
Plug cutter	25	140	13	529.250.31
Plug cutter	30	140	13	529.300.31

Forstner bits

SP Z2 V2 RH



537

D	L	S	ORDER NO.
mm	mm	mm	Right-hand rotation
10	90	8	537.100.31
12	90	8	537.120.31
14	90	8	537.140.31
15	90	8	537.150.31
16	90	8	537.160.31
18	90	8	537.180.31
20	90	8	537.200.31
22	90	8	537.220.31
24	90	8	537.240.31
25	90	8	537.250.31
26	90	8	537.260.31
28	90	8	537.280.31
30	90	8	537.300.31
32	90	10	537.320.31
35	90	10	537.350.31
38	90	10	537.380.31
40	90	10	537.400.31
45	90	10	537.450.31
50	90	10	537.500.31
55	90	10	537.550.31
68	157	12,7	537.680.31

D	L	S	ORDER NO.
inches	inches	inches	Right-hand rotation
1/4	3-35/64	3/8	537.064.31
3/8	3-35/64	3/8	537.095.31
1/2	3-35/64	3/8	537.127.31
5/8	3-35/64	3/8	537.158.31
3/4	3-35/64	3/8	537.190.31
7/8	3-35/64	3/8	537.222.31
1	3-35/64	3/8	537.254.31
1-1/8	3-35/64	3/8	537.285.31
1-1/4	3-35/64	3/8	537.317.31
1-3/8	3-35/64	3/8	537.349.31
1-1/2	3-35/64	3/8	537.381.31
1-5/8	3-35/64	3/8	537.413.31
1-3/4	3-35/64	3/8	537.445.31
1-7/8	3-35/64	3/8	537.476.31
2	3-35/64	3/8	537.508.31
2-1/8	3-35/64	3/8	537.540.31

TECHNICAL DETAILS:

- Super strength SP steel.
- Precision balanced centre point.
- 2 spurs [V2].
- 2 precision ground cutting edges [Z2].
- Long-lasting cutting performance.

APPLICATION: used to drill precise flat bottom holes with no chipping in any softwood thickness.

Forstner bit sets

We offer a wide range of Forstner bits in the most popular diameters. These bits are available separately or in beautiful wooden sets. The high performance stagger tooth design on the bits with larger diameters allows for sharp holes with straight sides and flat bottoms. Bits available for drill presses, electric and cordless drills and suitable to work on any type of softwood.

SP Z2 V2 RH



- 537.000.04**
- 537.000.05**
- 537.000.07**
- 537.000.12**

DESCRIPTION	SHANK	BIT DIAMETER	ORDER NO. Right-hand rotation
5 pcs. router bit set	Ø8-10mm	Ø15-20-25-30-35mm	537.000.05
12 pcs. router bit set	Ø8-10mm	Ø10-12-14-15-16-18-20-22-25-26-30-35mm	537.000.12
4 pcs. router bit set	Ø3/8"	Ø1/4" - 1/2" - 3/4" - 1"	537.000.04
7 pcs. router bit set	Ø3/8"	Ø1/4" - 3/8" - 1/2" - 5/8" - 3/4" - 7/8" - 1"	537.000.07
16 pcs. router bit set	Ø3/8"	Ø1/4" - 3/8" - 1/2" - 5/8" - 3/4" - 7/8" - 1" - 1-1/8" - 1-1/4" - 1-3/8" - 1-1/2" - 1-5/8" - 1-3/4" - 1-7/8" - 2" - 2-1/8"	537.000.16

Saw blades
Jig saw blades
Tools with bore & Knives
Router bits & sets
CNC router cutter & chucks
Industrial dowel drills
Bits for hand power tools
Power tools & accessories
Display cabinets & spare parts



531



D mm	L mm	S mm	Max RPM	ORDER NO. Right-hand rotation
54	73,5	9,5	1500	531.541
54	71,3	9,5	1500	531.542
54	67,3	9,5	1500	531.543
54	72,3	9,5	1500	531.544
70	76,5	9,5	1000	531.701
70	74	9,5	1000	531.702

- TECHNICAL DETAILS:**
- Super strength HS steel.
 - 2 HW precision ground cutting edges [Z2].
 - Parallel exagonal shank.
 - Right-hand rotation (RH).

APPLICATION: to be used on drill presses and drilling power tools at low RPMs (see table). We recommend clamping your workpiece mechanically during boring operations.

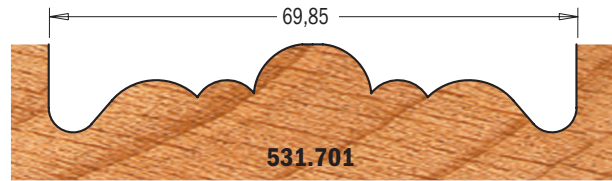
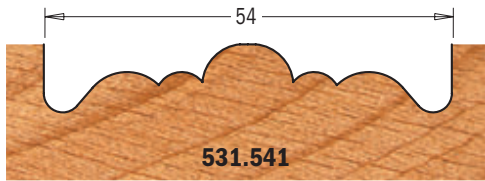

Drawings are 1:1 scale

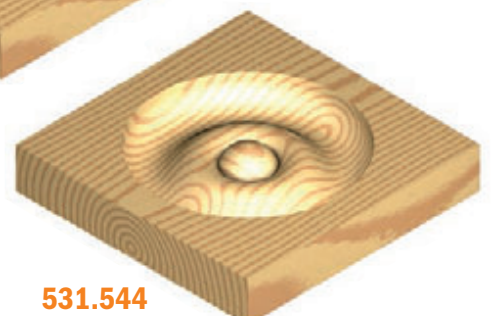
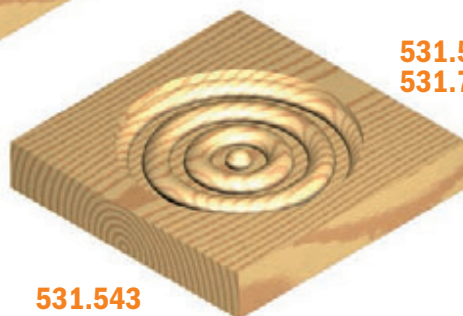
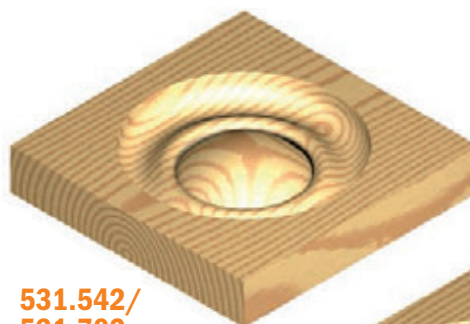
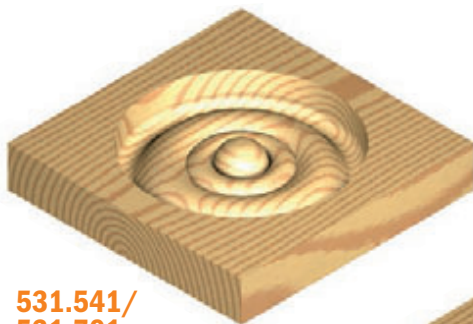

**531.541/
531.701**

**531.542/
531.702**

531.543

531.544

Brad point bits

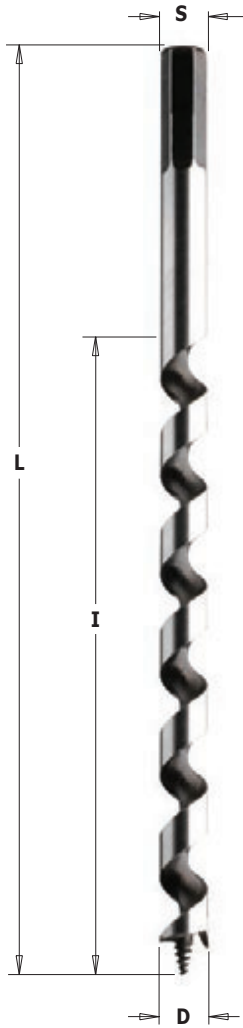
HS **Z1** **V1** **RH**

542-535

D mm	I mm	L mm	S	ORDER NO. Right-hand rotation
6	155	230	exagonal	542.060.51
8	155	230	exagonal	542.080.51
10	155	230	exagonal	542.100.51
12	155	230	exagonal	542.120.51
14	155	230	exagonal	542.140.51
16	155	230	exagonal	542.160.51
18	155	230	exagonal	542.180.51
20	155	230	exagonal	542.200.51
new 7	360	460	exagonal	535.070.51
8	360	460	exagonal	535.080.51
10	360	460	exagonal	535.100.51
12	360	460	exagonal	535.120.51
14	360	460	exagonal	535.140.51
16	360	460	exagonal	535.160.51
18	360	460	exagonal	535.180.51
20	360	460	exagonal	535.200.51

TECHNICAL DETAILS:

- Super strength HS steel.
- Precision balanced centre point.
- 1 precision ground cutting edge [Z1].
- 1 spiral flute.
- 1 spur [V1].
- Long-lasting cutting performance.

APPLICATION: used for drilling deep holes in soft and hardwood.

Brad point bits



540

HW **Z2** **V2** **RH**

D mm	L mm	S mm	ORDER NO. Right-hand rotation
5	90	8x30	540.050.11
6	90	8x30	540.060.11
8	90	8x30	540.080.11
10	90	8x30	540.100.11
12	90	8x30	540.120.11

TECHNICAL DETAILS:

- Super strength steel.
- HW head with precision balanced centre point.
- 2 precision ground cutting edges [Z2].
- 2 negatively ground spurs [V2].
- 2 spiral flutes

APPLICATION: for use on hand-held router to drill blind holes in solid wood, wood composites or plastic laminates.

541 Stop collars

D mm	ORDER NO.	Spare parts	
5	541.050.00		991.062.00
6	541.060.00		991.062.00
8	541.080.00		991.062.00
10	541.100.00		991.062.00
12	541.120.00		991.062.00

Stop collars with precision clamping nut and key for quick and easy assembly.

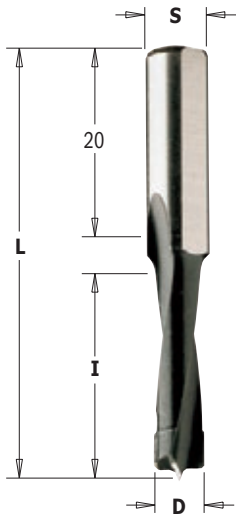

312



	D mm	I mm	L mm	S mm	ORDER NO. Right-hand rotation
new	4	30	58	8	312.040.11
	5	30	58	8	312.050.11
	6	30	58	8	312.060.11
	8	30	58	8	312.080.11
	10	30	58	8	312.100.11
	12	30	58	8	312.120.11
	14	30	58	8	312.140.11
	16	30	58	8	312.160.11

These drill bits are made with high-strength steel in order to work with high speed rotation. They are perfect to bore all materials like solid wood, wood and composites, plastic and laminated with **hand-held routers and MAFELL® machine model DD40.**

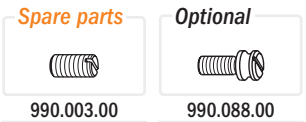

TECHNICAL DETAILS:

- Super strength steel.
- Spiral portion coated with black P.T.F.E.
- HW precision balanced centre point.
- 2 HW precision ground cutting edges [Z2].
- 2 spiral flutes.
- Parallel shank with driving flat and length adjusting screw.

Router bits for Domino® Joining machines by Festool®

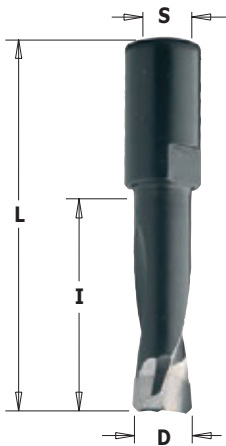

380



	D mm	I mm	L mm	S mm	FESTOOL®	ORDER NO. Right-hand rotation
	• 4	11	38	M6x0,75	DF500	380.040.11
	5	20	49	M6x0,75	DF500	380.050.11
	6	28	49	M6x0,75	DF500	380.060.11
	8	28	49	M6x0,75	DF500	380.080.11
new	8	50	70	M8x1	DF700	380.081.11
	10	28	49	M6x0,75	DF500	380.100.11
new	10	70	90	M8x1	DF700	380.101.11
new	12	70	90	M8x1	DF700	380.121.11
new	14	70	90	M8x1	DF700	380.141.11

• HWM

TECHNICAL DETAILS:

- Premium quality super-strength steel.
- Spiral portion coating with black P.T.F.E.
- Extra-fine micrograin carbide spiral portion.
- 2 cutting edges [Z2].
- 2 spiral flutes.

APPLICATION: for use on "Domino®" machines to rout slots on solid wood and wood composites.



Brad point bits

SP HS Z2 RH



517

D mm	I mm	L mm	S mm	ORDER NO. Right-hand rotation	SP	ORDER NO. Right-hand rotation	HS
3	33	61	3	517.030.31		517.030.51	
4	43	75	4	517.040.31		517.040.51	
5	52	86	5	517.050.31		517.050.51	
6	57	93	6	517.060.31		517.060.51	
7	69	109	7	517.070.31		517.070.51	
8	75	117	8	517.080.31		517.080.51	
9	80	120	9	517.090.31		517.090.51	
10	80	130	10	517.100.31		517.100.51	
11	89	142	8	517.110.31		517.110.51	
12	96	151	8	517.120.31		517.120.51	
13	96	151	8	517.130.31		517.130.51	
14	96	151	10	517.140.31		517.140.51	
15	100	160	10	517.150.31		517.150.51	
16	100	160	10	517.160.31		517.160.51	
18	130	180	10	517.180.31			
20	135	200	10	517.200.31			

SP

TECHNICAL DETAILS:

- Super strength SP steel.
- Precision balanced center point.
- 2 precision ground cutting edges [Z2].
- 2 flutes.

APPLICATION: used for drilling holes in softwood.

HS

TECHNICAL DETAILS:

- Super strength HS steel.
- Precision balanced center point.
- 2 precision ground cutting edges [Z2].
- 4 flutes.

APPLICATION: used for drilling holes in soft and hardwood.
Long-lasting cutting performance.

Brad point bit sets

HS SP Z2 RH



517

5 piece brad point bit set

An economical collection of the five most popular sized brad points - 4, 5, 6, 8 and 10mm. Safely packaged in a reusable plastic case for easy storage and inventory.

8 piece brad point bit set

A complete collection of the most popular brad points in the most requested sizes - 3, 4, 5, 6, 7, 8, 9 and 10mm. Safely packaged in a reusable plastic case for easy storage and inventory.

DESCRIPTION	Z	BIT DIAMETER	ORDER NO. Right-hand rotation
5 pcs. HS brad point set	4 flutes	(Ø4-5-6-8-10mm)	517.001.01
5 pcs. HS brad point set	2 flutes	(Ø4-5-6-8-10mm)	517.001.00
8 pcs. HS brad point set	4 flutes	(Ø3-4-5-6-7-8-9-10mm)	517.002.01
8 pcs. HS brad point set	2 flutes	(Ø3-4-5-6-7-8-9-10mm)	517.002.00



515

HS Z2 RH

ANUBA no.	d mm	D-S mm	I mm	I ₁ mm	LB mm	L mm	ORDER NO. Right-hand rotation
9,5	3,8	5,2	18	56	74	132	515.095.51
11	4,8	5,7	17	60	76	145	515.110.51
13	5,8	6,7	18	68	83	155	515.130.51
14,5	6,3	7,2	19	75	89	165	515.145.51
16	6,7	7,7	25	85	100	165	515.160.51
18	7,7	8,7	25	85	102	165	515.180.51
20	8,8	9,8	25	90	104	165	515.200.51

Parallel shank with driving flat

ANUBA no.	d mm	D mm	I mm	LB mm	S mm	L mm	ORDER NO. Right-hand rotation
9	3,8	5	20	40	10x35	75	515.091.51
11	4,2	5,7	20	45	10x35	80	515.111.51
13	5,2	6,5	15	50	10x35	85	515.131.51
14	5,5	7	15	55	10x35	90	515.141.51
16	6	7,7	15	60	10x35	95	515.161.51
18	6,6	8,2	20	70	10x35	105	515.181.51
20	7,2	8,7	20	80	10x35	115	515.201.51

TECHNICAL DETAILS:

- Super strength steel.
- HS steel.
- 2 HS precision ground cutting edges [Z2].
- 2 spiral flutes.

APPLICATION: used for drilling blind holes in soft and hardwood.



Brad point bits

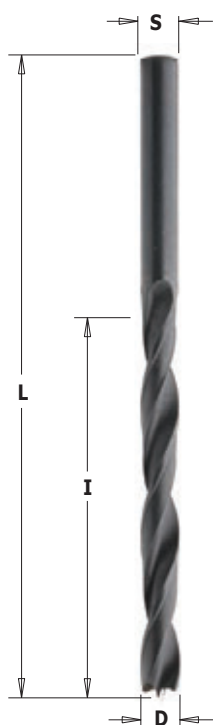

516

HS Z2 RH LH

D mm	I mm	L mm	S mm	ORDER NO. Right-hand rotation	ORDER NO. Left-hand rotation
2	24	49	2	516.020.51	516.020.52
2,5	30	57	2,5	516.025.51	516.025.52
3	33	61	3	516.030.51	516.030.52
3,5	39	70	3,5	516.035.51	516.035.52
4	43	75	4	516.040.51	516.040.52
4,5	47	80	4,5	516.045.51	516.045.52
5	52	86	5	516.050.51	516.050.52
5,5	57	93	5,5	516.055.51	516.055.52
6	57	93	6	516.060.51	516.060.52
7	69	109	7	516.070.51	516.070.52
8	75	117	8	516.080.51	516.080.52
9	81	125	9	516.090.51	516.090.52
10	87	133	10	516.100.51	516.100.52

TECHNICAL DETAILS:

- Super strength steel.
- Precision balanced centre point.
- 2 precision ground cutting edges [Z2].
- 2 spiral flutes.
- Common shank and cutting diameter (S=D).

APPLICATION: used for drilling holes in soft and hardwood.

Countersinks with threaded shank



350

HW **Z2** **RH** **LH**

D ₃ mm	S mm	ORDER NO. Right-hand rotation	ORDER NO. Left-hand rotation
3	M10/Ø11x4	350.030.11	350.030.12
4	M10/Ø11x4	350.040.11	350.040.12
5	M10/Ø11x4	350.050.11	350.050.12

TECHNICAL DETAILS:

- Super strength steel.
- 2 HW precision ground cutting edges [Z2].
- Quick and easy drill change.

Spare parts



990.001.00

APPLICATION: for use with spiral bits featuring parallel shank.

Countersinks with threaded shank

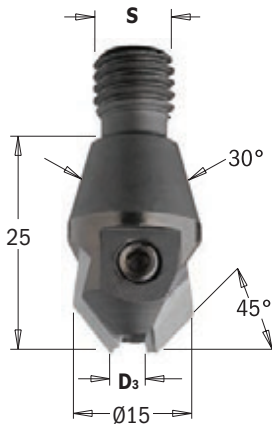

351

D ₃ mm	S mm	ORDER NO. Right-hand rotation	ORDER NO. Left-hand rotation
3	M10/30°	351.030.11	351.030.12
4	M10/30°	351.040.11	351.040.12
5	M10/30°	351.050.11	351.050.12

TECHNICAL DETAILS:

- Super strength steel.
- 2 HW precision ground cutting edges [Z2].
- Quick and easy drill change.

Spare parts



990.001.00

APPLICATION: for use with spiral bits featuring parallel shank.

Adjustable countersink

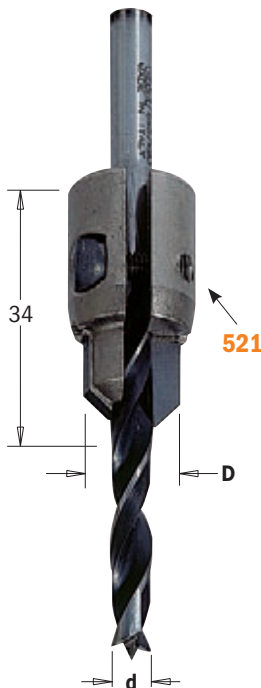

521.001

HW **Z2** **RH**

d mm	D mm	ORDER NO. Right-hand rotation	Spare parts	
3 ~ 7	11 ~ 15	521.001.11	990.061.00	991.067.00

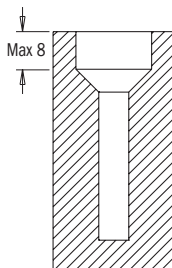

Twist drills	Overall diameter
Ø3	Ø11
Ø4	Ø12
Ø5	Ø13
Ø6	Ø14
Ø7	Ø15

TECHNICAL DETAILS:

- Premium quality HW.
- 2 HW precision ground cutting edges [Z2].
- Quick and easy drill change.

APPLICATION: for use with spiral bits featuring parallel shank.
Twist drills not included.

Drill bits with 45° countersink set

new

CMT ORANGE TOOLS™

HW Z2 RH

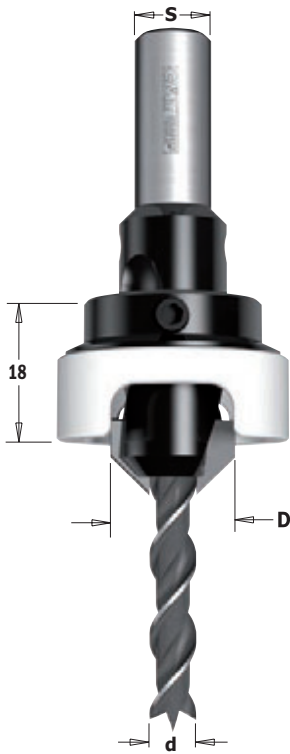

521A

d mm	D mm	A	S mm	ORDER NO. Right-hand rotation
3	12	45°	8	521.312.11A
4	12	45°	8	521.412.11A
5	16	45°	10	521.516.11A
6	16	45°	10	521.616.11A

Spare parts

521.312.11	517.030.51	541.101.00
521.412.11	517.040.51	541.101.00
521.516.11	517.050.51	541.141.00
521.616.11	517.060.51	541.141.00

Spare parts

990.014.00 Screw
991.060.00 Hex key

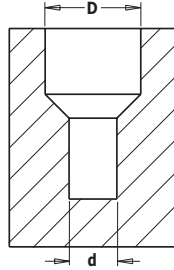

TECHNICAL DETAILS:

- Super strength steel.
- Countersink: 2 HW precision ground cutting edges [Z2].

APPLICATION: used for drilling holes in soft, hardwood and wood composites.

Stop collars with precision clamping nut for quick and easy assembly. The Delrin® protection sleeve lets you work without leaving marks on the workpiece.

Drill bits with 90° countersink set

new

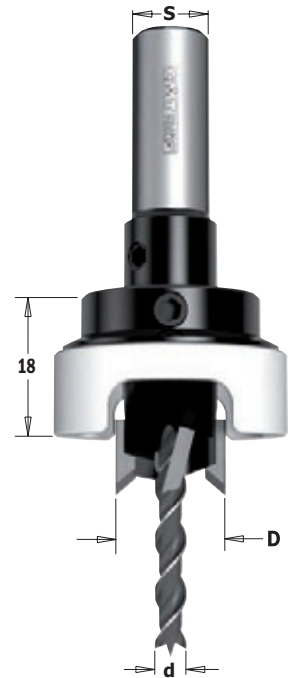

515A

d mm	D mm	D ₂ mm	S mm	ORDER NO. Right-hand rotation
4	12	10	10	515.412.11A
4	14	12	10	515.414.11A
5	15	14	10	515.515.11A
6	14	12	10	515.614.11A
6	15	14	10	515.615.11A

Spare parts

515.412.11	517.040.51	541.101.00
515.414.11	517.040.51	541.121.00
515.515.11	517.050.51	541.141.00
515.614.11	517.060.51	541.121.00
515.615.11	517.060.51	541.141.00

Spare parts

990.014.00 Screw
991.060.00 Hex key

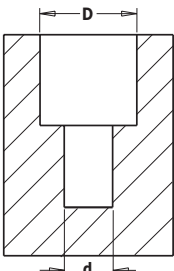

TECHNICAL DETAILS:

- Super strength steel.
- Countersink: 2 HW precision ground cutting edges [Z2].
- Countersink: 2 HW negatively ground spurs [V2].

APPLICATION: used for drilling holes in soft, hardwood and wood composites.

Stop collars with precision clamping nut for quick and easy assembly. The Delrin® protection sleeve lets you work without leaving marks on the workpiece.

Stop collars with Delrin® sleeve

new

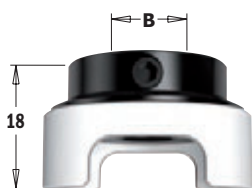

541

B mm	ORDER NO.
10	541.101.00
12	541.121.00
14	541.141.00

Spare parts

990.014.00	991.060.00
990.014.00	991.060.00
990.014.00	991.060.00

Stop collars with precision clamping nut for quick and easy assembly. The Delrin® protection sleeve lets you work without leaving marks on the workpiece.

45° countersink with parallel shank

new

CMT ORANGE TOOLS™

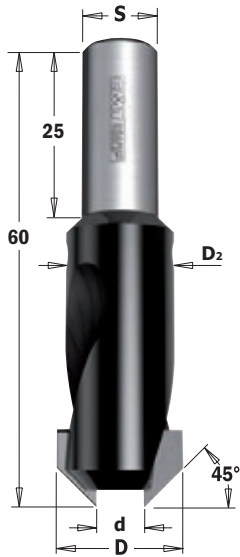

521

HW Z2 RH LH

d mm	D mm	D ₂ mm	A	S mm	ORDER NO. Right-hand rotation	ORDER NO. Left-hand rotation	Spare parts
3	12	10	45°	8	521.312.11	521.312.12	990.014.00
4	12	10	45°	8	521.412.11	521.412.12	990.014.00
5	16	14	45°	10	521.516.11	521.516.12	990.014.00
6	16	14	45°	10	521.616.11	521.616.12	990.014.00

Spare parts 991.060.00 2mm hex key

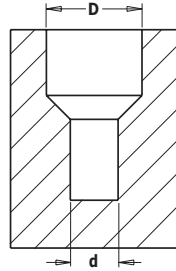

TECHNICAL DETAILS:
 - Super strength steel.
 - 2 HW precision ground cutting edges [Z2].

90° countersink with parallel shank

new

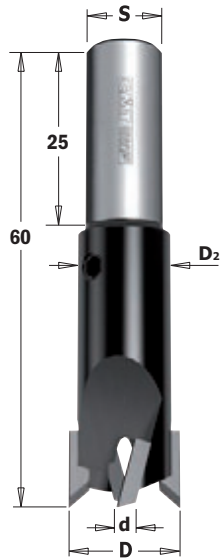

515

HW Z2 V2 RH

d mm	D mm	D ₂ mm	A	S mm	ORDER NO. Right-hand rotation	ORDER NO. Left-hand rotation	Spare parts
4	12	10	90°	10	515.412.11		990.014.00
4	14	12	90°	10	515.414.11		990.014.00
5	15	14	90°	10	515.515.11		990.014.00
6	14	12	90°	10	515.614.11		990.014.00
6	15	14	90°	10	515.615.11		990.014.00

Spare parts 991.060.00 2mm hex key

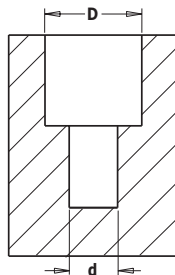

TECHNICAL DETAILS:
 - Super strength steel.
 - 2 HW precision ground cutting edges [Z2].
 - 2 HW negatively ground spurs [V2].

Saw blades

Jig saw blades

Tools with bore & Knives

Router bits & sets

CNC router cutter & chucks

Industrial dowel drills

Bits for hand power tools

Power tools & accessories

Display cabinets & spare parts

Power tools, jig accessories, display cabinets & spare parts



PRODUCTS	PAGE
Routers	270 - 271
Router tables	272 - 273
Professional straight edge clamps	274
Superjaws portable clamping system	274
Dovetail jig	276 - 277
Eclipse & circle cutting jig	278
CMT-Enlock joining system	279
Kitchen worktop jig	280
Inlay kit	281
3D router carver system	282 ~ 284
Organizer	284
Pocket-Pro joinery system	285
Boring systems	286 ~ 291
Blade & bit cleaner	289
Diamond whetstones	292 - 293
Flexible templates for routing	294
Bowl and tray system	295
Digital angle gauge & finder	296 - 297
Display cabinets	298 ~ 301
Spare parts	302 ~ 306

1000W router

QUICK ACCESS BRUSHES
allows the end user to change worn brushes.



SAFETY SWITCH SHUTTER
locks closed in bit change mode to prevent power on.



SIDE AIR VENTS
reduces intake of dust into the motor casing when mounted upside-down in a router table.



ELECTRONIC SPEED CONTROL & SOFT START
From 8.000 - 20.000 RPM.

FULLY ENCLOSED GUARDING
provides maximum protection from the cut zone.

MULTI-FUNCTION FENCE
provides excellent control for hand-held use and circle cutting.

QUICK FIT PINS
for fast fitment and removal from its fence.

Optional



- Bushes**
 Ø 7,93mm
 9,52mm
 11,1mm
 12,7mm
 15,87mm
 19,05mm
 20,2mm

CMT7E-TGA

CMT7E-TGA Template guide kit includes 7 guide bushes, a guide plate, and alignment bush, and spacers.

Optional for CMT7E-TGA

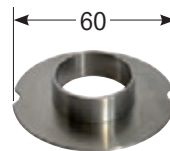

DESCRIPTION	ORDER NO.
Guide bush Ø30mm	899.007.07
Guide bush Ø27mm	899.008.07

Optional

Clamping nuts and collets for CMT8E

Diametre	ORDER NO.
D = 6mm	796.660.00
D = 6,35mm	796.664.00
D = 8mm	796.680.00
D = 10mm	796.700.00
D = 12mm	796.720.00
D = 12,7mm	796.727.00



TECHNICAL SPECIFICATIONS

- Horsepower 1.000 Watt
- No load speed 8.000-20.000 RPM
- Plunge stroke 0-59mm
- Collet diametre..... Ø6-12,7mm
- Tool weight..... 4 Kg

STANDARD EQUIPMENT

- Extended baseplate with adjustable fence
- Dust extraction outlet
- Easy adjustment
- Wrench for easy cutter change

- Ø8 and Ø12mm collets
- 1 year warranty
- Instruction manual

Worldwide technical assistance

DESCRIPTION	ORDER NO.
Router complete with standard equipment	CMT8E

2400W router



CMT7E

REMOVABLE PLUNGE SPRING

for easy bit adjustment when table mounted.



ELECTRONIC SPEED CONTROL & SOFT START

From 8.000 - 20.000 RPM

SWITCH FROM A PLUNGE TO A FIXED BASE ROUTER

by simply pressing or releasing the button.



QUICK ACCESS BRUSHES

allows the end user to change worn brushes.



SAFETY SWITCH SHUTTER

locks closed in bit change mode to prevent power on.



FULLY ENCLOSED GUARDING

provides maximum protection from the cut zone.

MULTI-FUNCTION FENCE

provides excellent control for hand-held use and circle cutting.

SIDE AIR VENTS

reduces intake of dust into the motor casing when mounted upside-down in a router table.

QUICK FIT PINS

for fast fitment and removal from its fence.

3 STAGE TURRET

with direct reading scales for precise preset cut depths.



TOP OF TABLE HEIGHT ADJUSTMENT

Top of table height adjustment is possible using the height winder handle from the template guide kit.

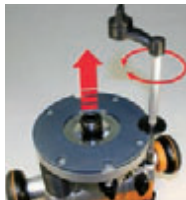

TECHNICAL SPECIFICATIONS

- Horsepower 2.400 Watt
- No load speed 8.000-20.000 RPM
- Plunge stroke 0-68mm
- Collet diameter..... Ø6-12,7mm
- Tool weight..... 6 Kg

STANDARD EQUIPMENT

- Extended baseplate with adjustable fence
- Dust extraction outlet
- Infinite micro adjustment
- Wrench for easy cutter change
- Ø8 and Ø12mm collets
- 1 year warranty
- Instruction manual

Worldwide technical assistance

Optional

Clamping nuts and collets for CMT8E

Diametre	ORDER NO.
D = 6mm	796.660.00
D = 6,35mm	796.664.00
D = 8mm	796.680.00
D = 10mm	796.700.00
D = 12mm	796.720.00
D = 12,7mm	796.727.00



Optional

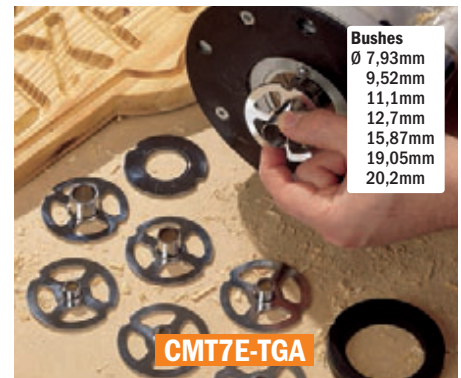

- Bushes**
- Ø 7,93mm
 - 9,52mm
 - 11,1mm
 - 12,7mm
 - 15,87mm
 - 19,05mm
 - 20,2mm

CMT7E-TGA

CMT7E-TGA Template guide kit includes 7 guide bushes, a guide plate, and alignment bush, and spacers.

Optional for CMT7E-TGA

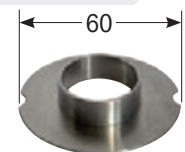

DESCRIPTION	ORDER NO.
Guide bush Ø30mm	899.007.07
Guide bush Ø27mm	899.008.07

DESCRIPTION

Router complete with standard equipment

ORDER NO.

CMT7E



Saw blades
Jig saw blades
Tools with bore & Knives
Router bits & sets
CNC router cutter & chucks
Industrial dowel drills
Bits for hand power tools
Power tools & accessories
Display cabinets & spare parts

Industrio routing system



CMT has turned the Industrio routing system into a great tool with new accessories such as phenolic insert, integral aluminium scales and an improved fence. Also, you will find some new optional features, such as a rugged moulded featherboard and a new mitre gauge.

999.500.01

The system includes:

999.501.09

Unique phenol top with new insert plate

Now featuring a 298x374mm (11-3/4"x14-3/4") insert plate, the top is milled from 12mm (15/32") thick phenol. Sturdy and very enduring material, phenol is much more resistant to warping than melamine. The top also features new aluminium scales on both ends to set the fence quickly and properly.

Easy fast bit change

No need to remove the router or fumble beneath the table top to change the bits. CMT's useful bent wrench allows you to replace the bits from above quickly and easily. 15 kg. shipping weight.

999.501.10 Pivoting, zero-clearance fence with new clamping system

Our extruded aluminium fence can be used as conventional locked-in-place fence or as a pivoting fence. New, quick-adjusting clamps on both ends of the fence make adjustments a breeze, especially when used in conjunction with the aluminium scales that we've added to the table top. The fence also includes a sub fence of high density white plastic for an ultra smooth feeding surface, with a replaceable centre section to create zero-clearance inserts. 8,5 kg shipping weight.

999.501.03 Sturdy melamine cabinet

This sturdy 20mm-thick (25/32") melamine cabinet is easy to assembly with posts and cross dowels. Also, it includes a double-door storage area to keep bits, wrenches and more tools safe and dust-free. 32,5 kg. shipping weight.

Router table dimensions:
79x59x(h)93cm. - 55 kg. weight

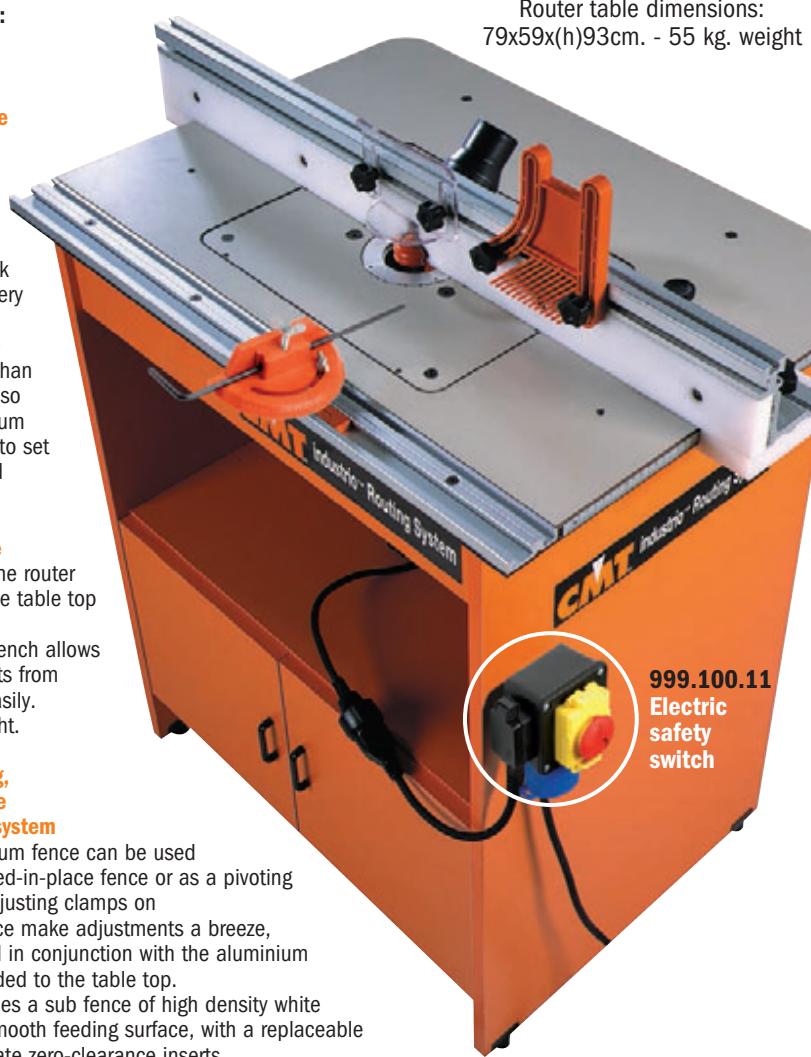

999.501.07_Moulded ABS featherboard setup on the table and in fence slots. In includes nuts, bolts and a plastic slide.



999.501.08_Mitre gauge.



999.501.18_Phenolic plate with aluminium rings (Ø103-69,5mm) for CMT7E.



999.502.34_Centring device to position your router perfectly in the 8-12mm (5/16"- 15/32") insert plate.



999.100.11 Electric safety switch

Optional

Bent wrenches for easy bit replacement

- 17mm991.005.00
- 21mm991.002.00
- 22,2mm991.004.00
- 23,8mm991.003.00
- 24mm991.006.00*
- 28,6mm991.001.00

* For CMT7E and CMT8E routers

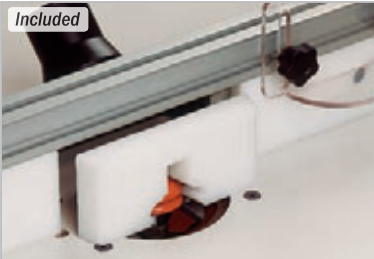

999.502.10_Central section of the fence is removable for custom replacements.

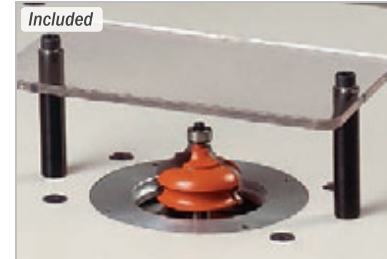

999.501.06_The dual and post guard makes freehand work safer.

DESCRIPTION	ORDER NO.
Industrio routing system (with plate prebored for CMT7E)	999.500.01
CMT7E router and 999.500.01 Industrio routing system + 999.100.11 Electric safety switch	CMT7E-IND
Electric safety switch (mandatory for CE legislation)	999.100.11
Optional:	
Universal phenolic plate with aluminium rings (Ø103-69,5mm), not bored (for not CMT routers)	999.501.26
Phenolic plate with (Ø103-69,5mm) aluminium rings for CMT8E router	999.501.27
Pair of (Ø103-69,5mm) reduction rings	999.501.05N

CMT Professional router table system



999.100.00

Router table dimensions:
68x50x(h)85cm. - 25 kg. weight

Our quality bits have been designed for you, the professional craftsman, to allow you to confidently work at your best. CMT now offers even more possibilities with our professional router table: the perfect place to combine your skills and CMT quality. The professional router table system has a strong and sturdy MDF laminate work surface measuring 68x50x2,5cm for easy mobility when working. This free standing table sits at a comfortable height of 85cm on solid high gauge steel legs and weighs 25 kg. The universal plate are adaptable to all brands and models of routers on the market and provide shank holder options to select any bit up to 90mm in diameter. Choose any of our wide range of CMT bits including multi profile and molding bits or even kitchen set bits and work easily and safely on this table!

999.100.11
(mandatory for CE legislation)

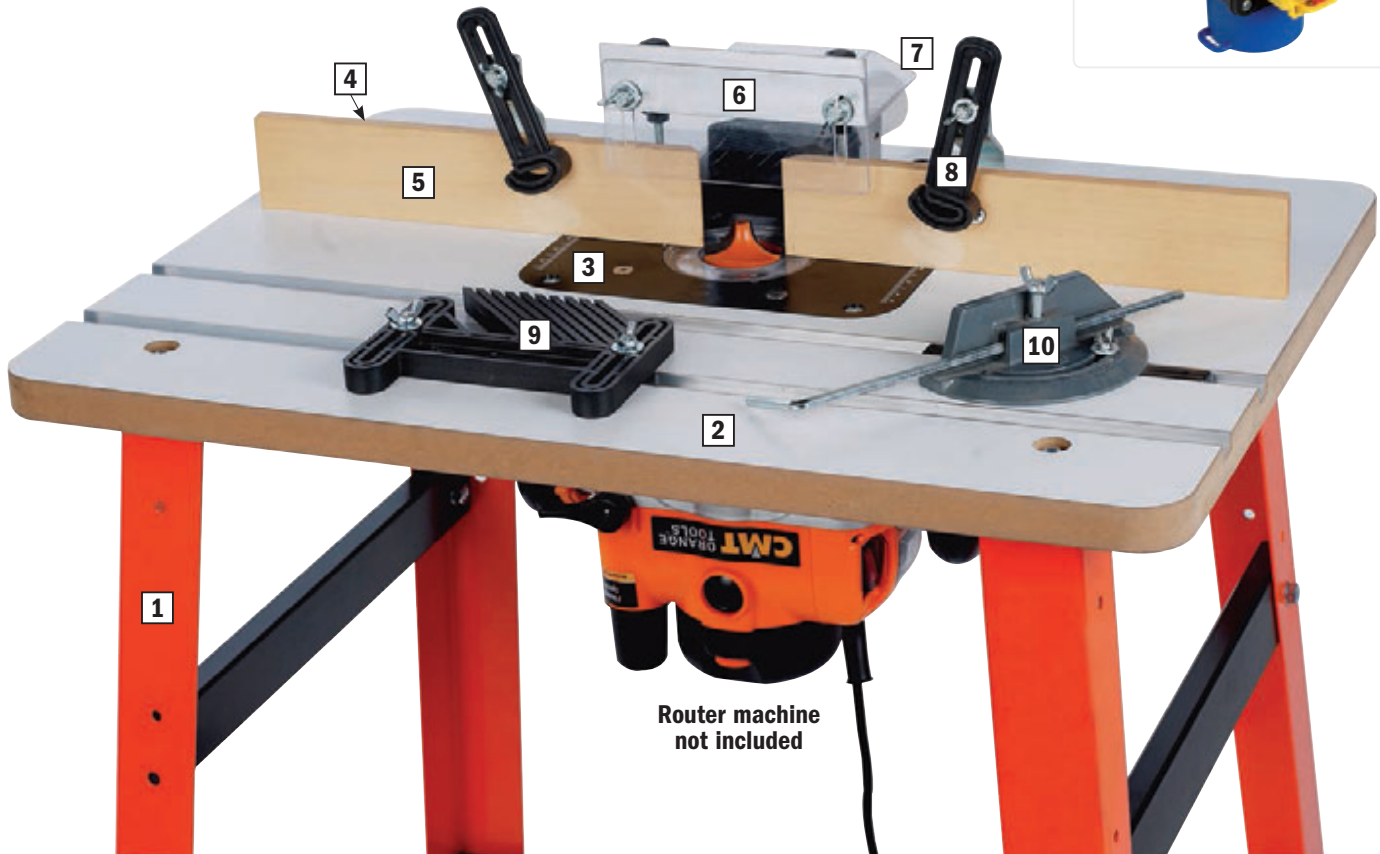

DESCRIPTION	ORDER NO.
CMT professional router table system:	999.100.00
Electric safety switch (mandatory for CE legislation)	999.100.11
CMT7E router and 999.500.01 Industrio routing system + 999.100.11 Electric safety switch	CMT7E-IND
Spare parts included with the table:	
1) High gauge steel legs	999.100.01
2) Thick MDF work surface with aluminium fluting	999.100.02
3) Plate (235x170x8mm) with 30-40mm reduction rings prebored for CMT7E	999.100.33
4) Aluminium support for wooden fence	999.100.04
5) Longitudinal wooden fence (RH - LH)	999.100.05
6) Lexan® and aluminium safety shield	999.100.06
7) Vacuum hose	999.100.07
8) Standing spring press	999.100.08
9) Moulded ABS feather board	999.100.09
10) Transversal mitre gauge	999.100.10
Optional:	
Universal plate (235x170x8mm) with 30-40mm reduction rings not bored (for not CMT routers)	999.100.03
Plate (235x170x8mm) with 30-40mm reduction rings prebored for CMT8E	999.100.34

Saw blades

Jig saw blades

Tools with bore & Knives

Router bits & sets

CNC router cutter & chucks

Industrial dowel drills

Bits for hand power tools

Power tools & accessories

Display cabinets & spare parts

Professional straight edge clamps

new

CMT ORANGE TOOLS™

PGC

Used as a fence for your bandsaw, drill press or even as an auxiliary fence on your router table or table saw, CMT's professional straight edge clamps represent a two-in-one tool, allowing you to either use them as an edge guide, or to easily clamp your boards or any object for woodworking. Available in different sizes. Here are the main features:

- Made of extruded aluminium for easy carriage and enhanced durability.
- Light, yet more rigid than any other clamps on the market.
- Measuring scales, low-profile jaws, built-in T-tracks on the top allowing the use of accessories or jigs.
- Either single or back-to-back clamps.

DESCRIPTION	ORDER NO.
Professional Straight Edge Clamp 610mm	PGC-24
Professional Straight Edge Clamp 915mm	PGC-36
Professional Straight Edge Clamp 1270mm	PGC-50

Low-profile clamps allow for accurate cuts, dados and grooves. In addition they properly work as an auxiliary fence on your drill press or router table. Sturdy jaws hold your workpiece to the full length of the clamp without any side-to-side play. Back-to-back clamps with the suitable accessories also let you manage your woodworking operations with a lot of versatility. Adjustable scale and two T-tracks allow you to use many accessories.

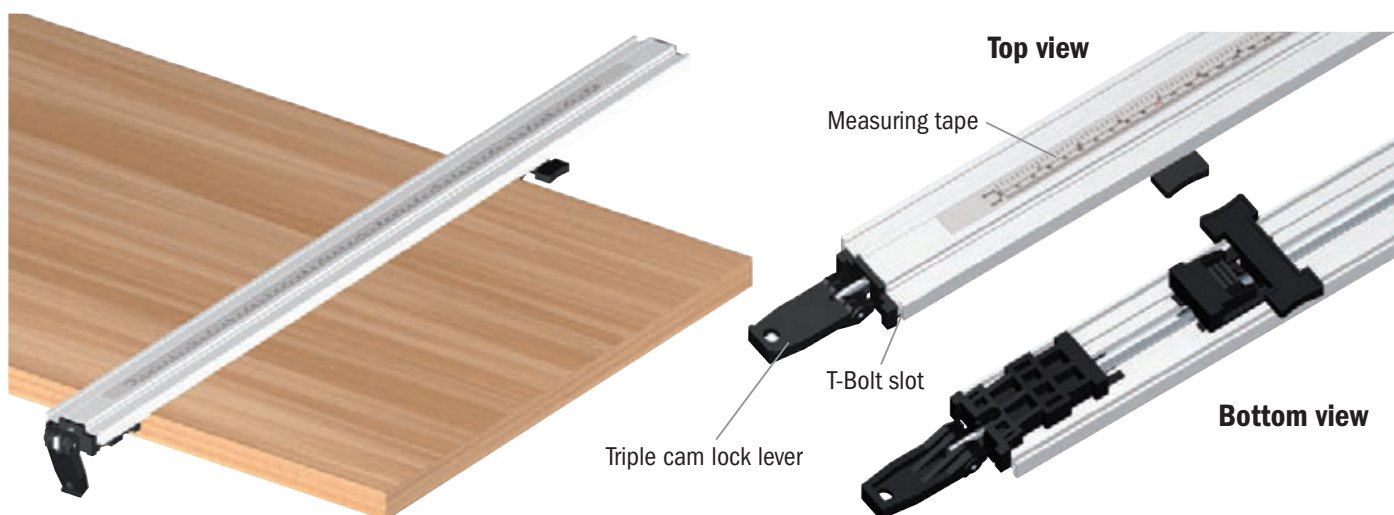

Back-to-Back connectors for straight edge clamps (optional)

new

Lay two more straight edge clamps on the back of the other pair of straight edge clamps and secure them by using your back-to-back connectors.

Fasten the bottom jaw pads to the table top and clamp wood with the top jaw pads. Thanks to the low profile jaws your work surface is never obstructed.

The back-to-back straight edge clamps can also be taken apart for making two separate clamps.

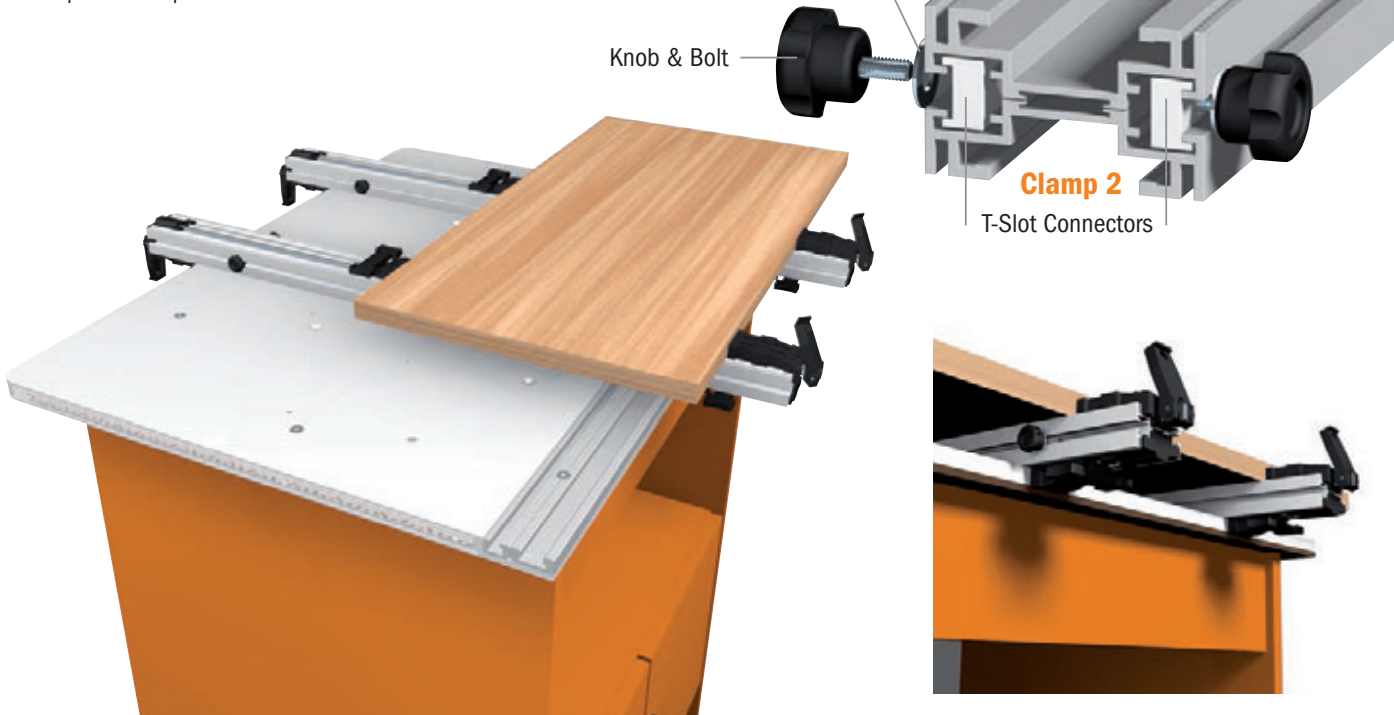

DESCRIPTION	ORDER NO.
Back to Back Connectors for straight edge clamps (8 pieces)	PGC-B2B

Superjaws portable clamping system

CMT200

LOCK / RELEASE SWITCH

allows fast, trouble-free release of the jaws.

URETHANE JAW FACINGS

provide a protective, slip-resistant grip.

REVERSIBLE SLIDING JAWS

allow for extra wide 956mm clamping width capacity.

FOOT OPERATED CLAMPING

frees up your hands for full control of the job.

ROBUST, ALL-STEEL CONSTRUCTION WITH POWDERCOAT FINISH

for long-lasting operation.

POWERFUL 1 TONNE CLAMPING FORCE

allows the ability to apply as much or as little clamping pressure as you require.

QUICKLY FOLDS DOWN FOR STORAGE AND TRANSPORT

TRIPOD BASE

for all-terrain stability.

The CMT200 SuperJaws is the workstation you take right to the job; indoors, outdoors, construction sites or the factory floor. It provides fast and easy hands-free clamping action of material up to 956mm and features a massive force of up to 1000kg, for all clamping or pressing applications. It holds anything: car parts, bicycles, timber and tubing.

TECHNICAL SPECIFICATIONS

- Clamping Range 0 - 956mm
- Clamping Force Up to 1000kg
- Clamping Method Foot operated
- Standard Jaws Urethane
- Max. Load: 100kg approx.
- Folding Time 20 seconds approx.
- Folded Size 275 x 775 x 295mm
- Standing Size 980 x 1000 x 860mm
- Weight 16kg

DESCRIPTION	ORDER NO.
SuperJaws Portable Clamping System	CMT200
<i>Optional</i>	
Pair of jaws for clamping logs and pole for chain sawing, etc.	CMT200-01
Pair of tough cast iron jaws for heavy duty metal work	CMT200-02
Support foot to enhance work station stability	CMT200-03
Extension tray to keep all your tools within your hand's reach	CMT200-04
Pair of black polyurethane jaws	CMT200-05

ACCESSORIES OPTIONAL



CMT200-01

Log Jaws
Pair of jaws for clamping logs and pole for chain sawing, etc.

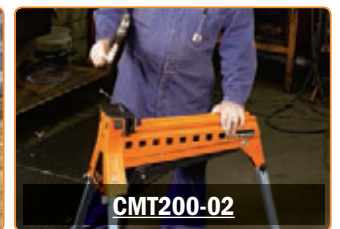

CMT200-02

Engineers Jaws
Pair of tough cast iron jaws for heavy duty metal work.



CMT200-03

Support foot
To enhance work station stability.



CMT200-04

Extension tray
To keep all your tools within your hand's reach.

new
new

CMT300

305mm max length
11~25mm joint thickness

Universal dovetail jig

Dovetail joints give a touch of craftsmanship to your work, but many woodworkers avoid these joints, because of their apparent complexity. CMT's new 305mm dovetail jig is the fast easy solution! Thanks to precise templates, permanent stops and easy adjustments, we have taken the "tinkering" out of the dovetail joinery. Simply clamp your workpiece in with the edges against the factory-set stops, set your bit depth and then you are ready to rout.

Also, we haven't cut corners on quality either. This jig features steel body, templates, stops and clamping bars, so it produces perfect long-lasting joints for all your woodworking needs. The machine accepts stock from 11mm to 25mm thick, and is capable of producing a variety of joints with the available templates. Standard jig includes a template for 12,7mm half blind joints and a template guide. Optional templates are available for through dovetail and box joints.



Standard equipment
 · Standard Ø12,7mm silver blind template **CMT300-T128**
 · Ø15,8x4mm template guide
899.005.00

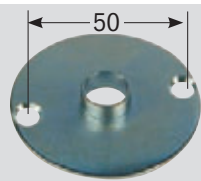

MASSIVE STEEL BODY SOLID SUPPORT

EASY-TO-GRID HANDLE

IMPORTANT TIP



HW DOVETAIL BITS (not included):

- 718.127.11** D=12,7mm A=14° S=6mm
- 818.128.11** D=12,7mm A=14° S=6,35mm
- 918.127.11** D=12,7mm A=14° S=8mm
- 818.628.11** D=12,7mm A=14° S=12,7mm



Will the template fit my router?

Standard template guide attaches using two screws spaced 50mm on centre. Many routers accept this design. If your router does not, order one of the listed universal router bases below:

Universal router bases

- For Ø8 and Ø12mm shank
- For Ø6,35 and Ø12,7mm shank
- Prebored router plate for CMT7E and CMT8E

ORDER NO.

- CMT300-SB1**
- CMT300-SB2**
- CMT300-SB**

Here's how it works:

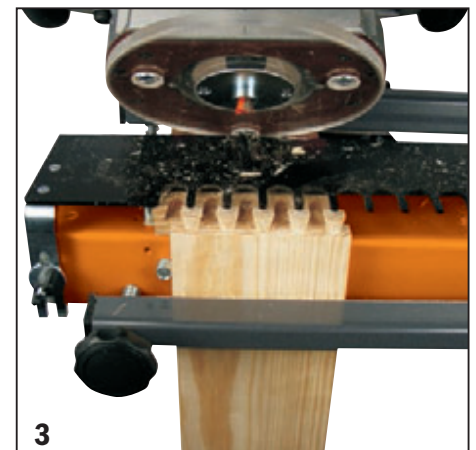
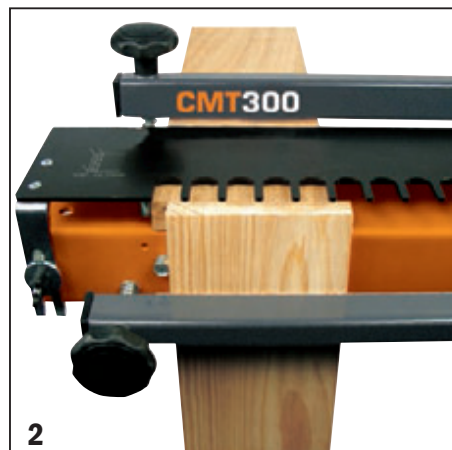

Saw blades
Jig saw blades
Tools with bore & Knives
Router bits & sets
CNC router cutter & chucks
Industrial dowel drills
Bits for hand power tools
Power tools & accessories
Display cabinets & spare parts

Half blind template CMT300-T064

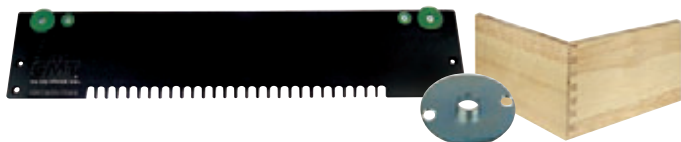

Template length mm	Dovetail size mm	Thickness mm	Colour	ORDER NO.
300	6,3	8 ~ 12	green	CMT300-T064

Supplied with Ø7,8x4mm precision guide **899.003.00**

To be used with CMT dovetail router bits:
 Ø8x8mm HW bit (Ø6mm shank) **718.060.11**
 Ø6,35x8,3mm HW bit (Ø6,35mm shank) **818.064.11**

Through dovetail templates CMT300-T129 - T190

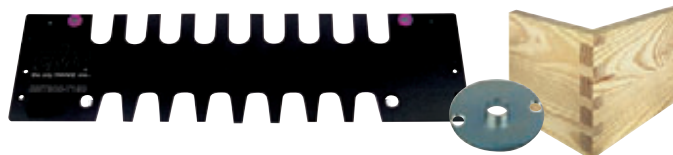

Template length mm	Dovetail size mm	Thickness mm	Colour	ORDER NO.
300	12,7	8 ~ 20	brown	CMT300-T129

Supplied with Ø11,1x4mm precision guide **899.004.00**

To be used with CMT straight router bits:
 Ø8x25mm HW bit (shank Ø6,35mm) **811.081.11**
 Ø8x30mm HW bit (shank Ø8mm) **912.080.11**

To be used with CMT dovetail router bits:
 Ø12,7x20mm HW bit (Ø6,3mm shank) **818.129.11**
 Ø12,7x20mm HW bit (Ø8mm shank) **918.129.11**

Box joint templates CMT300-T080 - CMT300-T127

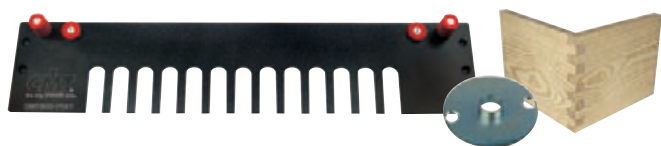

Template length mm	Dovetail size mm	Thickness mm	Colour	ORDER NO.
300	8	8 ~ 20	blue	CMT300-T080

Supplied with Ø11,1x4mm precision guide **899.004.00**

To be used with CMT straight router bits:
 Ø8x25mm HW bit (Ø6,35mm shank) **811.081.11**
 Ø8x30mm HW bit (Ø8mm shank) **912.080.11**

Template length mm	Dovetail size mm	Thickness mm	Colour	ORDER NO.
300	12,7	8 ~ 20	red	CMT300-T127

To be used with CMT straight router bits:
 Ø12,7x30mm bit HW (Ø6,35mm shank) **812.127.11**
 Ø12,7x30mm bit HW (Ø8mm shank) **912.127.11**
 Ø12,7x25mm bit HW (Ø12,7mm shank) **811.627.11**

Template length mm	Dovetail size mm	Thickness mm	Colour	ORDER NO.
300	19	15 ~ 22	violet	CMT300-T190

Supplied with Ø22x4mm precision guide **899.006.00**

To be used with CMT straight router bits:
 Ø12,7x30mm HW bit (Ø6,35mm shank) **812.127.11**
 Ø12,7x30mm HW bit (Ø8mm shank) **912.127.11**
 Ø12,7x25mm HW bit (Ø12,7mm shank) **811.627.11**

To be used with CMT dovetail router bits:
 Ø19x22mm HW bit (Ø6mm shank) **718.190.11**
 Ø19x22mm HW bit (Ø6,35mm shank) **818.190.11**
 Ø19x22mm HW bit (Ø8mm shank) **918.190.11**
 Ø19x22mm HW bit (Ø12mm shank) **918.690.11**
 Ø19x22mm HW bit (Ø12,7mm shank) **818.690.11**

Precision guide for router:

DESCRIPTION	ORDER NO.
7,8 x 4mm	899.003.00
11,1 x 4mm	899.004.00
15,8 x 4mm	899.005.00
22 x 4mm	899.006.00
30 x 4mm	899.007.00

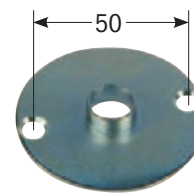

Here are a few of the beautiful dovetail joints you can produce using CMT bits

Half blind

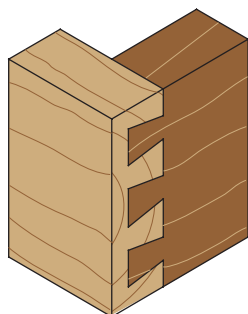

CMT300 - T064
CMT300 - T128 (INCLUDED with CMT300)

Box joint

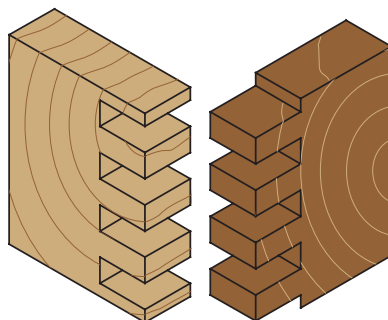

CMT300 - T080
CMT300 - T127

Through dovetail

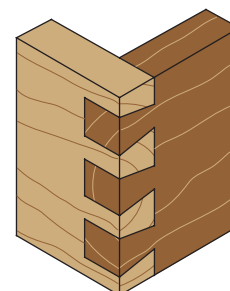

CMT300 - T129
CMT300 - T190

This product has been designed for cutting ellipses and circles with any router types. You can make ellipses and circles for windows, doors and any other application. By using two slides into the T-slot you can cut ellipses, whereas if you use one slide, you can cut circles.

Ellipse & circle cutting jig



Slider in the T-slot of the cross frame

CMT3000 ellipse jig includes:

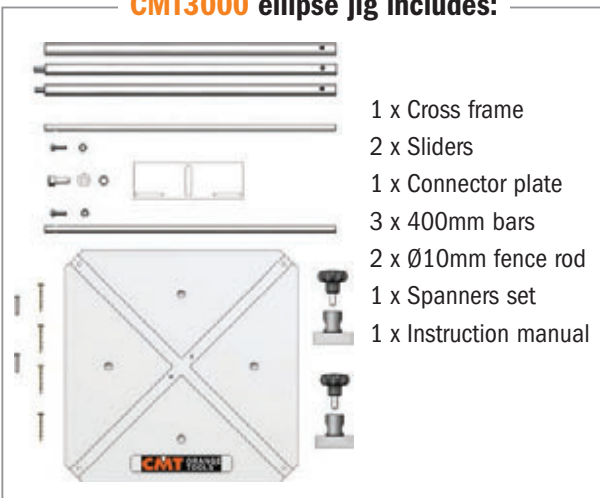

- 1 x Cross frame
- 2 x Sliders
- 1 x Connector plate
- 3 x 400mm bars
- 2 x Ø10mm fence rod
- 1 x Spanners set
- 1 x Instruction manual

Ellipse and circle cutting jig:

- Precise and rapid creation of ellipses and circles.
- Simple setup and effective operating.
- Clamping system for any type of routers.
- Special plastic cross frame with excellent sliding performance.
- Precisely machined T-slots and steel sliders.
- Zinc-coated metal parts to prevent rust.
- Delivered in a carton box along with instruction manual.

Major axis	Minor axes	
	Max	Min.
3000	2890	2590
1800	1690	1390
1500	1390	1090
1030	920	620
900	790	620
730	620	620
Min/max cutting radius		550/1500
Package dimension (mm)		405x360x54
Weight		6,6 kg.

Here are a few examples you can produce using **CMT3000 ellipse**

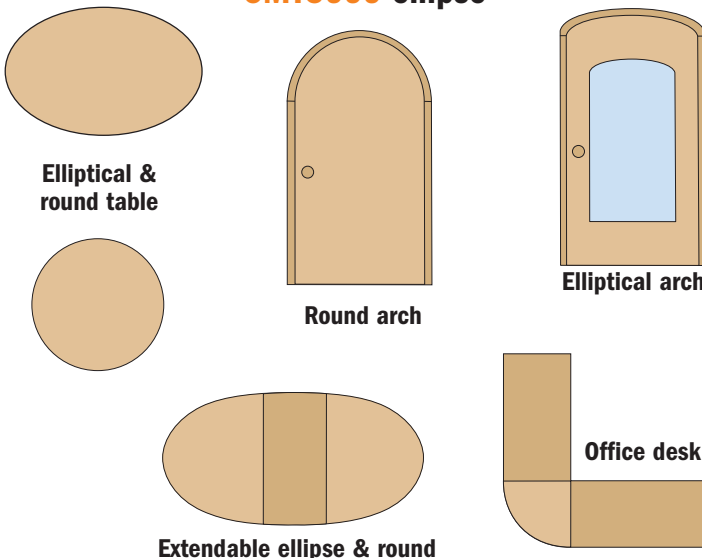

Optional

new



CMT3000-SB1
Ø170x15mm Delrin® guide plate for CMT3000 to be used with CMT7E & CMT8E

DESCRIPTION	ORDER NO.
Ellipse & circle cutting jig	CMT3000
Optional:	
400mm robust bar to extend the working radius	CMT3000-7
2 pcs. of fence rod for routers with bars up to Ø8mm in diameter	CMT3000-8
new Ø170x15mm Delrin® guide plate for CMT3000 to be used with CMT7E & CMT8E	CMT3000-SB1

Saw blades
Jig saw blades
Tools with bore & Knives
Router bits & sets
CNC router cutter & chucks
Industrial dowel drills
Bits for hand power tools
Power tools & accessories
Display cabinets & spare parts

CMT-Enlock joining system

CMT-Enlock1

Patent No. AU2005/903586
PCT/AU2006/000957

Width range 30~75mm
Thickness range 19~35mm

The innovative CMT-Enlock joining system is designed to build the strongest "T", "Mitre" joints and "Edge-to-edge" assemblies using the patented E15 and E10 dovetail keys. The dovetail slots in each part to be joined are machined quickly and accurately using the CMT Enlock jig. Simply clamp your workpiece in the jig, set the bit depth and you are ready to rout. The jig features strong cast aluminium construction throughout the body, top plate, stops and clamping bar to produce perfect strong joints for life!

1. The strong and versatile clamping bar ensures no workpiece movement.

2. Solid cast aluminium body.

3. Support foot to fix the jig on the table.

4. Adjustable mitre blocks for mitre joints in picture frames.

5. Adjustable mitre plate to suit the workpiece width.

6. Clamp extension arm to make widening joints.

Standard equipment
CMT-Enlock1 joining system
CMT-Enlock10 masterpack (50 keys)
Instruction manual (in five languages)
Video available on www.cmtutensili.com
Hw dovetail bits not included

Patented system

The CMT-Enlock dovetail key expands when the cap is forced in. This widens the dovetail producing a strong clamping force across the joint. No other dovetail system on the market produces this clamping force.

Here are a few of the beautiful joints you can produce using CMT-Enlock Jig

T-Joint

Edge-to-edge assemblies

Mitre joints

"T" joints

A few seconds and your joints are ready!



Order now!

DESCRIPTION	ORDER NO.
Complete joining system	CMT-Enlock1
Optional	
Ø9,5mm 50 key masterpack	CMT-Enlock10
Ø12,7mm 50 key masterpack	CMT-Enlock15
Ø9,5mm dovetail bit (Ø6mm shank)	718.098.11B
Ø12,7mm dovetail bit (Ø6mm shank)	718.127.11B
Ø9,5mm dovetail bit (Ø6,35mm shank)	818.098.11B
Ø12,7mmdovetail bit (Ø6,35mm shank)	818.128.11B

CMT650

For perfect joint

For kitchen worktops from 420mm to 650mm in width.

CMT650 is designed to cut kitchen worktop joints with any type of router.

Letter code system for different operations makes the jig work much easier and very quick.

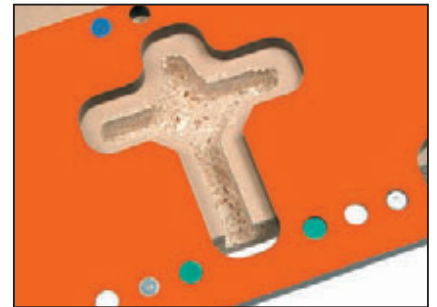

Kitchen worktop jig

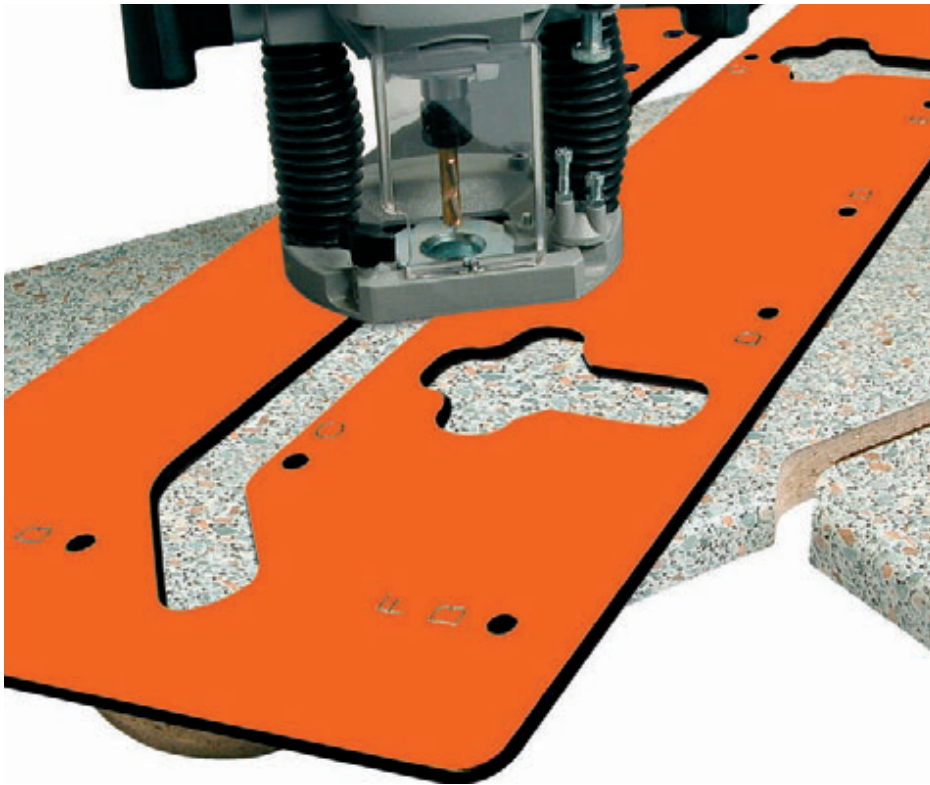

Joints made in 15 minutes! Including setup time

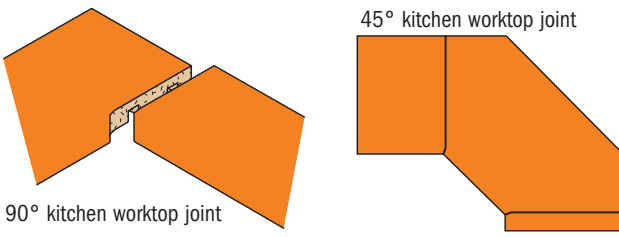

JIG INCLUDES:

- 1pc. Phenolic template
- 3pc. Zinc-coated steel location bush
- 1pc. Adjustable end stop
- 1pc. Instruction manual

Optional

new

- Portable router
- Guide bush Ø30mm*
- HW straight bit Ø12mm
- Two clamps

* COMBINATION ROUTERS/ACCESSORIES

Router	Bush guide	Base Plate
CMT7E	899.007.00	CMT300-SB
CMT8E	899.007.00	CMT300-SB
NO-CMT	899.007.00	CMT300-SB1

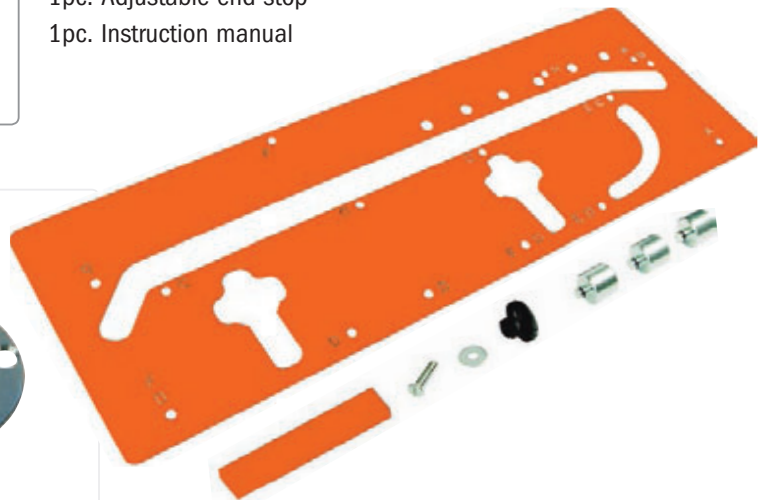

Bits for the jig:

We recommend the use of these Ø12mm straight bits:

ORDER NO.	DESCRIPTION
912.120.11	Ø12x31,7 S=8mm
652.120.11	Ø12x28,3 S=8mm
912.621.11	Ø12x38,1 S=12mm
912.622.11	Ø12x50,8 S=12mm
812.620.11	Ø12x31,7 S=12,7mm
812.621.11	Ø12x38,1 S=12,7mm
652.121.11	Ø12x48,3 S=12mm
652.621.11	Ø12x48,3 S=12,7mm

CMT650 is designed for Ø12mm straight bits.

- Template made of stable and hardened material.
- For 90° and 45° joints
- Integrated templates for rounding over and chamfering edges.
- Extra location bush for worktop width of 600mm.
- Two integrated templates for panel bolt recesses.
- Delivered with a clear and comprehensive instruction manual.

DESCRIPTION	ORDER NO.
Kitchen worktop jig	CMT650

Saw blades
Jig saw blades
Tools with bore & Knives
Router bits & sets
CNC router cutter & chucks
Industrial dowel drills
Bits for hand power tools
Power tools & accessories
Display cabinets & spare parts

Beautiful, professional-quality inlays aren't as difficult as they seem. In fact, they are easy with CMT inlay kit. Just remove and reassemble the small bushing to make the recess in the workpiece and cut out the inlay. Perfect for toy making, puzzle making, lettering and lots of other decorative projects. Use the spiral bit for routing MDF, or the straight bit for natural wood.

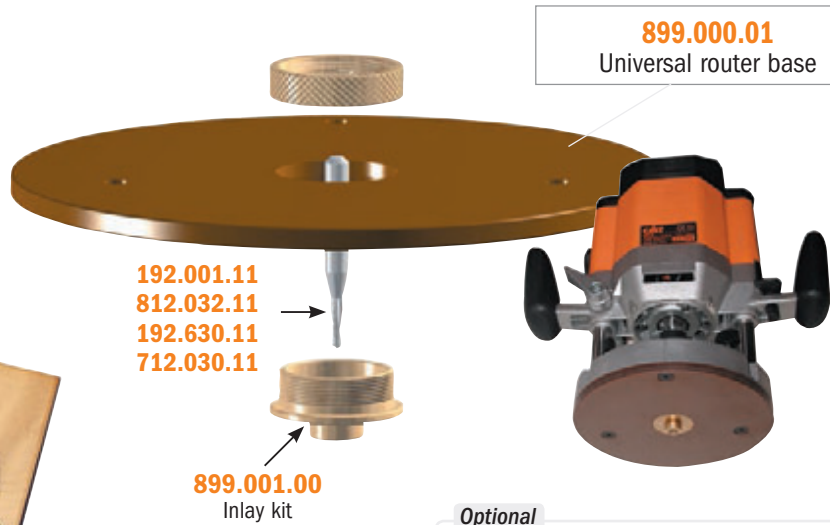

Complete instructions for assembling and using CMT inlay kit are included.

DESCRIPTION	ORDER NO.
Inlay kit with 3,2mm (1/8") HWM spiral bit (Ø6,35mm shank)	899.051.00
Inlay kit with 3,2mm (1/8") HWM straight bit (Ø6,35mm shank)	899.052.00
Solid brass template guide	899.001.00
Universal router base	899.000.01
Router base for CMT7E	899.000.02
3,2mm (1/8") HWM spiral bit (Ø6,35mm shank)	192.001.11
3,2mm (1/8") HWM straight bit (Ø6,35mm shank)	812.032.11
3mm HWM spiral bit (Ø6mm shank)	192.630.11
3mm HWM straight bit (Ø6mm shank)	712.030.11

Optional

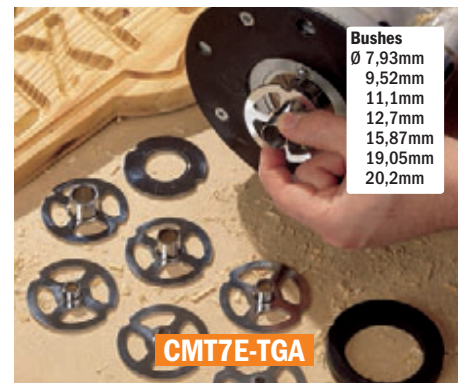

CMT7E-TGA_Template guide kit includes 7 guide bushes, a guide plate, and alignment bush, and spacers. It could be used with CMT7E and CMT8E routers.

Here's how it works:

Make your pattern

Make your pattern in the desired shape of your inlay out of 6,35mm (1/4") thick material. For better results use masonite or similar smooth materials, avoid square corners, and be sure the opening is wide enough to place a 14,2mm(9/16") bushing.

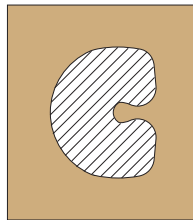

Rout the workpiece

Attach the brass inlay guide to your router with the snap-on bushing in place. Set the bit depth to match your inlay stock. Attach the pattern to your workpiece and rout out the mortise for the inlay.

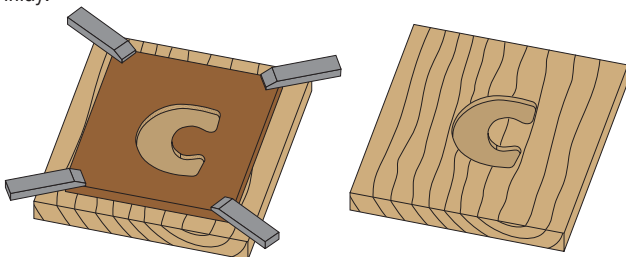

Rout the inlay

Temporarily attach the inlay stock to a piece of scrap with two-sided tape. Now attach your pattern to the inlay material. Take off the snap-on bushing and rout around the opening in the pattern very carefully. Be sure the template guide keeps tight to the perimeter of the pattern at all times.

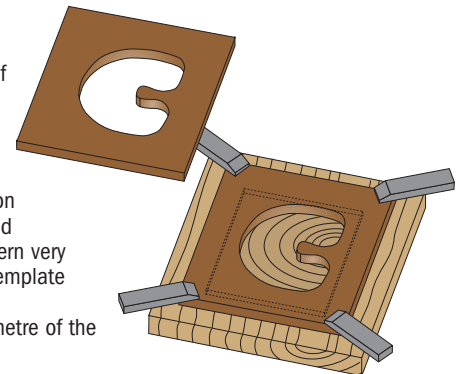

Assemble everything

Make sure the two workpieces fit perfectly. If it is necessary sand the inlay material. Apply adhesive and carefully tap the inlay in place. Use a wood block to protect the inlay stock. Sand as needed and that's it.

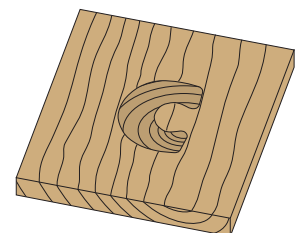

Complete detailed instructions in English are included in the kit. Instructions in Spanish, French, German and Italian are available on www.cmtutensili.com

3D Router Carver™ system

Exclusively from your CMT distributor

RCS

Turn your router into a remarkable carving tool. It's fast, easy, and a whole lot of fun!

Who says that intricate woodcarving requires an artist's touch? Thanks to the patented 3D Router Carver system, anyone with a plunge router can create any of the beautiful designs shown on these pages in just minutes. Decorate doors, drawers, cabinets, furniture or just about any flat wooden surface with one or more of these designs. How does it work? The secret is in the 3D Router Carver Bit and the way that bit interacts with the carving templates. The V-Groove router bit is enclosed in a 45° cone-shaped guide. You rout with the plunge mechanism of your router **unlocked**, allowing the bit to move up or down as the router moves forward. As the slot in the template get wider, the bit moves down, producing a wider, deeper V-groove. As the slot gets narrower, the bit moves up, and the groove gets narrower and shallower. It sounds simple, and it is! (that's why the system is patented worldwide). Please see the illustrations below for more details on the carving technique. You'll receive complete instructions with your 3D Carver templates. For an informative visual demonstration, check out the 3D Router Carver video on our web site.

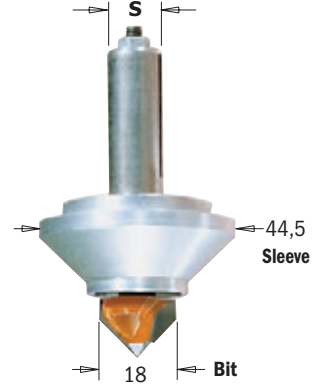



What do you need to get started?

- The 3D Router Carver bit
- The Carver template of your choice
- The Holding frame to match your template
- Your plunge router

(Note: Be sure the opening in the base of your router is at least 47,6mm in diameter. If it isn't, you'll need to make a sub-base to accept the large diameter of the 3D Carver bit.)

3D Router carver bit & sleeve

S mm	ORDER NO. Right-hand rotation	Spare parts					Optional
8	RCS-BIT8						
12,7	RCS-BIT	RCS-CUT8	RCS-SLE8	RCS-SHIELD	RCS-NUT8	991.007.00	RCS-SLEEVE8
		RCS-CUT	RCS-SLE	RCS-SHIELD	990.091.00	990.092.00	RCS-SLEEVE

Here's how it works:

1. Clamp or tack the holding frame to your workpiece

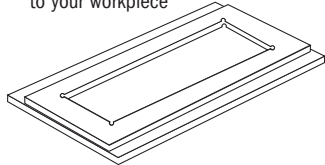

2. Drop the template into the holding frame

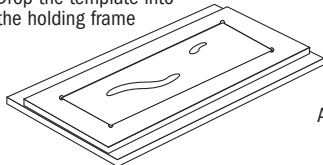

3. Plunge the bit into a wide part of the slot and rout with the router's plunge mechanism unlocked.

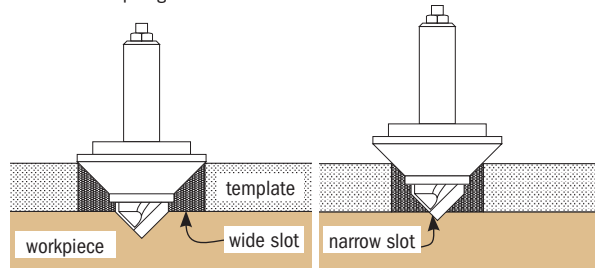

Allow the plunge mechanism to move up and down as you advance. Wider template slots allow wider, deeper grooves. Narrower slots produce shallower grooves.

4. With the frame still in place, flip the template & rout again. Some templates will be routed 2 to 4 times, depending on the complexity of the design.

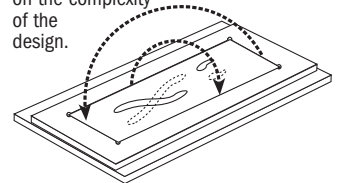

5. Remove the frame and you're finished!

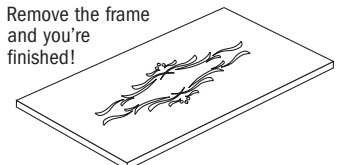

Cabinet door & panel carvings

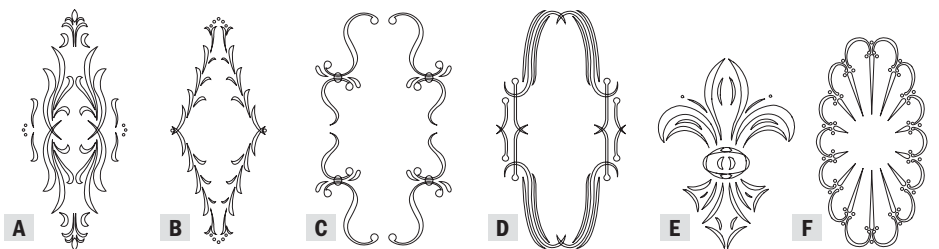

These designs are ideal for the doors or panels of cabinets, entertainment centers, fireplace surrounds or almost any flat surface. See the designs below for complementary patterns for drawers, rails and corners. Approximate carving time is 5 minutes.

DESCRIPTION	Carving dimensions mm	No. of templates	ORDER NO.
Classical cabinet door - A	440 x 185	2	RCS-302
Florentine cabinet door - B	415 x 170	2	RCS-304
Cascade cabinet door - C	365 x 210	1	RCS-305
Roma cabinet door - D	375 x 200	1	RCS-306
Fleur-de Lys door - E	250 x 180	4	RCS-805
Spanish fan template - F	380 x 200	2	RCS-806
Cabinet door holding frame			RCS-003

Saw blades
Jig saw blades
Tools with bore & Knives
Router bits & sets
CNC router cutter & chucks
Industrial dowel drills
Bits for hand power tools
Power tools & accessories
Display cabinets & spare parts



Panel and rail carvings

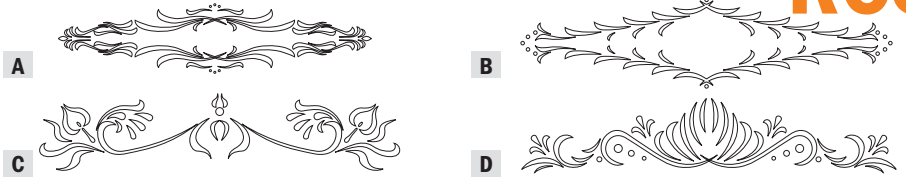

Tip: many carvings, like the Florentine rail, are enhanced with the additional of a rosette.

With a long, horizontal shape, these designs are perfect for door rails, headboards, cabinet face frames and valences. Approximate carving time is 4 minutes.

DESCRIPTION	Carving dimensions mm	No. of templates	ORDER NO.
Classical rail - A	550 x 120	2	RCS-402
Florentine rail - B	550 x 130	2	RCS-404
Cascade rail - C	530 x 110	3	RCS-405
Folklore rail - D	550 x 110	3	RCS-406
Rail holding frame			RCS-004

Drawer and furniture carvings

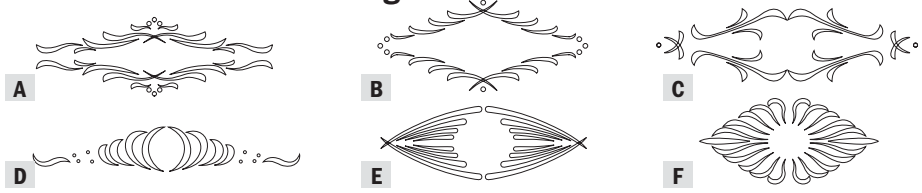

Originally intended for drawer fronts, these designs are great for lots of other projects: small doors, side panels of cabinets, furniture and more. For door and drawer combinations, match the style of the door designs above. Approximate carving time is 4 minutes.

DESCRIPTION	Carving dimensions mm	No. of templates	ORDER NO.
Classical drawer - A	210 x 70	2	RCS-502
Florentine drawer - B	195 x 85	2	RCS-504
Cascade drawer - C	250 x 65	1	RCS-505
Folklore drawer - D	250 x 40	2	RCS-506
Roma drawer - E	190 x 65	2	RCS-507
Blaze drawer - F	250 x 110	2	RCS-510
Drawer holding frame			RCS-005

Corner & small decoration carving designs



DESCRIPTION	Carving dimensions mm	No. of templates	ORDER NO.
Classical corner - A	155 x 40	3	RCS-602
Florentine corner - B	120 x 30	3	RCS-604
Cascade corner - C	190 x 40	3	RCS-605
Folklore corner - D	150 x 45	3	RCS-606
Corner holding frame			RCS-006

Rosette carvings

You get two templates for the price of one with these designs! Each item includes templates for two sizes of rosette. Use with the rosette frame sold above, or use the large rosettes with the cabinet door frame or small rosettes with rail frame.

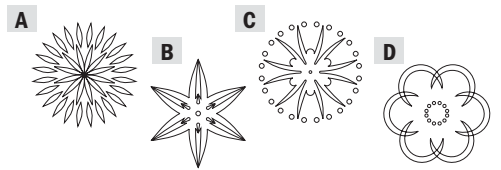

DESCRIPTION	Carving diameter mm	No. of templates	ORDER NO.
Rosette #1 & #5 - A	85 & 68	2 & 2	RCS-701
Rosette #2 & #6 - B	88 & 70	1 & 1	RCS-702
Rosette #3 & #7 - C	82 & 65	1 & 1	RCS-703
Rosette #4 & #8 - D	79 & 62	1 & 1	RCS-704
Rosette holding frame			RCS-007

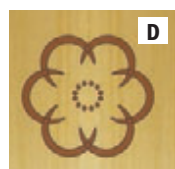
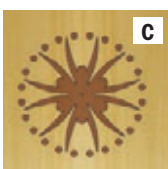
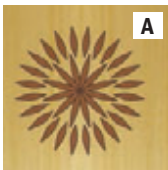

3D Router Carver™ system

RCS

Saw blades

Jig saw blades

Tools with bore & Knives

Router bits & sets

CNC router cutter & chucks

Industrial dowel drills

Bits for hand power tools

Power tools & accessories

Display cabinets & spare parts

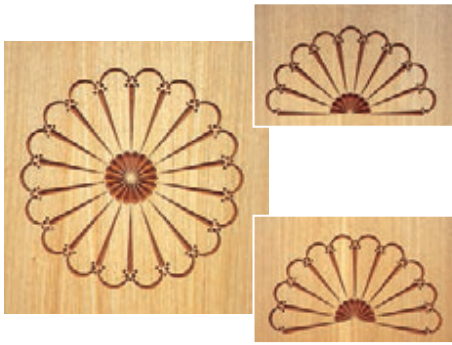

Southwestern carving designs

These popular Southwestern designs are actually several shapes in one. Both sizes can be routed as circular carvings, or use only portions of the template to suit your project.

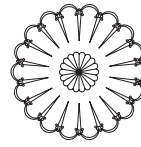

Rout the complete spanish fan design or make partial rosettes

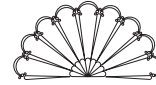

DESCRIPTION	Carving dimensions mm	No. of templates	ORDER NO.
Large spanish fan	400	1	RCS-801
Small spanish fan	200	1	RCS-802
Rosette holding frame			RCS-007

Just for fun: Designs For every animal lover!



Your imagination will be your guide on these neat designs. Furniture or decorations for the kids, paneling for the den or rec room, a gift for the sportsman - who knows?

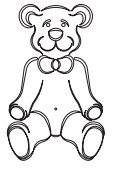

DESCRIPTION	Carving dimensions mm	No. of templates	ORDER NO.
Dolphin - A	200 x 290	4	RCS-803
Eagle - B	178 x 298	4	RCS-804
Deer - C	394 x 190	4	RCS-901
Horse - D	445 x 203	3	RCS-902
Longhorn - E	419 x 194	4	RCS-904
Teddy bear - F	394 x 203	3	RCS-906
Cabinet door holding frame			RCS-003

Organizer

100 bits at your fingertips

When you constantly work on projects, you always need your most used bits right within hand's reach and safely organized. CMT gives you the perfect solution for keeping them all in sight, thanks to the 100 piece organizer. This conveniently holds any size router or drill bit by using CMT's interchangeable bushings to fit all CMT shank diametres. See options listed below.

03.51



DESCRIPTION	ORDER NO.
Bit organizer (without bushings)	03.51.0106
Interchangeable bushings for Ø6mm shank (20 pcs)	03.51.0046A
Interchangeable bushings for Ø6,35mm shank (20 pcs)	03.51.0047A
Interchangeable bushings for Ø8mm shank (20 pcs)	03.51.0048A
Interchangeable bushings for Ø9,5mm shank (20 pcs)	03.51.0057A
Interchangeable bushings for Ø10mm shank (20 pcs)	03.51.0058A
Interchangeable bushings for Ø12mm shank (20 pcs)	03.51.0059A
Interchangeable bushings for Ø12,7mm shank (20 pcs)	03.51.0049A

Pocket-Pro™ joinery system

For fast, easy and accurate cabinet & furniture construction. Designed by CMT and professional cabinetmakers, this new system allows you to make rock-solid pocket hole joints in stock 12,7mm (1/2") to 40mm (1-5/8") thick with unprecedented speed and accuracy.

The heart of the Pocket-Pro™ system is our unique moulded jig, which features hardened drill bushings and an interlocking two-piece design. Sliding the jig up or down enables you to adjust the stock thickness in preset 1,6mm (1/16") increments without test joints or measurements! If you have used other pocket hole jigs you will be familiar with many joint applications, but you will benefit from many Pocket-Pro™ system advantages.

For example:
- some jigs require adding or removing various parts of the jig to join different stock thicknesses. With the Pocket-Pro™ system you simply have to adjust the interlocking jig up or down for the full range of joints 12,7mm (1/2") to 40mm (1-5/8") thick;

- other jigs require frequent repositioning of the depth stop collar for different joint styles. CMT's Pocket-Pro™ joinery system allows you to make most of the adjustments leaving the stop collar in the same position of the drill bit;

- plus, with CMT's Pocket-Pro™ system you can quickly adjust the location of the pocket in relation to the end of your workpiece to create a stronger joint by using longer screws, or to leave more "meat" in the joint.

Check out the Pocket-Pro™ joinery system today. Easy enough for beginners and accurate enough for professional workers, it is the world's most versatile pocket hole jig.

PPJ-002

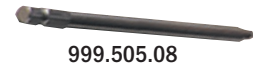

DESCRIPTION	ORDER NO.
Pocket-Pro™ joinery system set	PPJ-002
Set contains:	
Pocket-Pro™ main parts	999.505.10
Toggle clamp	999.505.05
9,5mm (3/8") step drill bit	515.001.51
9,5mm (3/8") depth collar for step drill bit	541.095.00
152mm (6") Square drive screw driver bit	999.505.08
Masterpack 30 screw 1-1/4"	990.101X30

DESCRIPTION OPTIONAL	ORDER NO.
500 fine screws (31,7mm)	990.101X500
500 coarse screws (31,7mm)	990.102X500
500 fine screws (38,1mm)	990.103X500
500 coarse screws (38,1mm)	990.104X500
Face clamp swivel pad	999.505.06
6mm (3") square drive screwdriver bit	999.505.07

Optional

999.505.06
Face clamp with swivel pad



Enjoy Easy Pocket Hole Joinery!

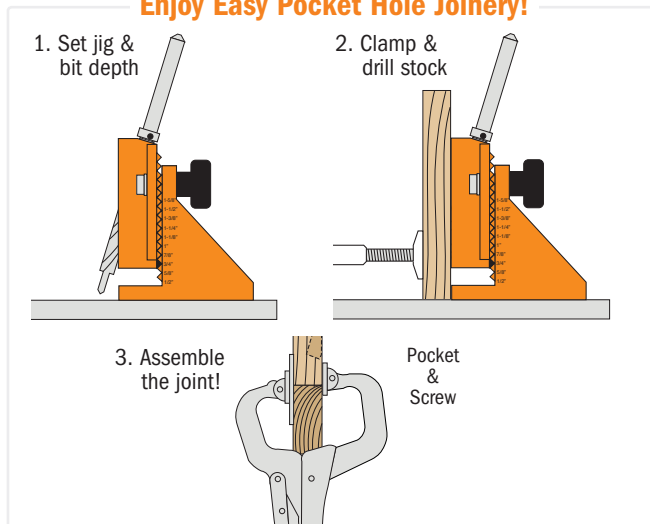

Build almost anything!

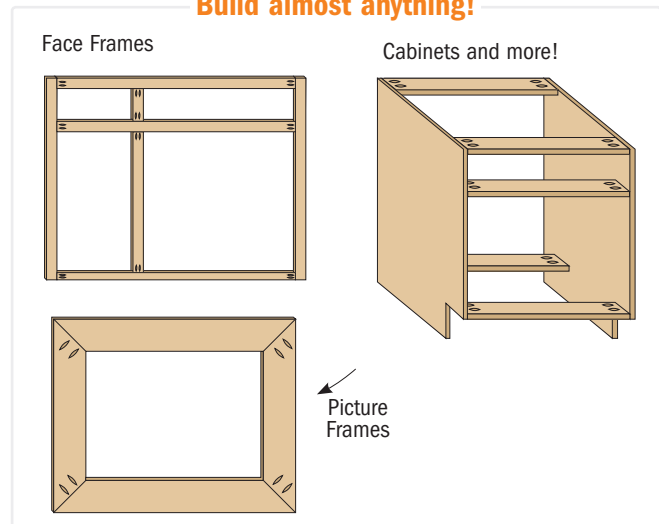

Universal hinges boring system

The innovative CMT333 hinge boring system with 3 spindle-heads allows you to bore holes for any hinge brand, such as Salice, Blum, Hettich, Würth, Mepla, Grass, etc.. The universal modular base supports the installation of 5 different boring heads, engineered by the worldwide leading company in industrial boring machines. Use the CMT333 universal hinge boring system on all hand-held or standing drilling power tools.

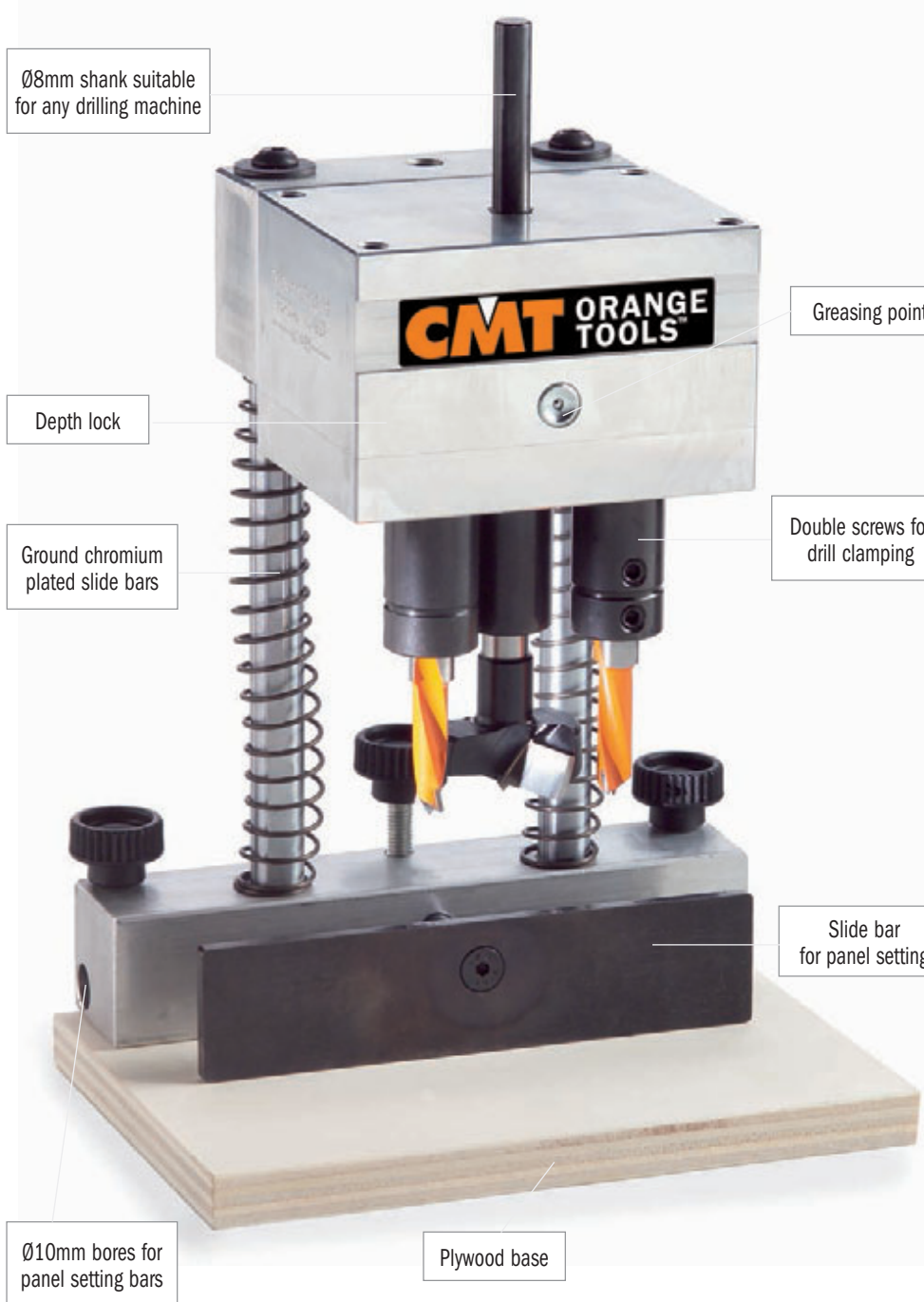

For use on standing drilling machines



To use on standing drilling power tools



For use on CMT Industrio™ router table

Technical features and specifications

- Complete anti-rust parts
- Ground aluminium (Avional)
- Max 5000 RPM
- Six radial antifriction bearings

Safety tips:

for lubrication use oil SHC100 Mobil

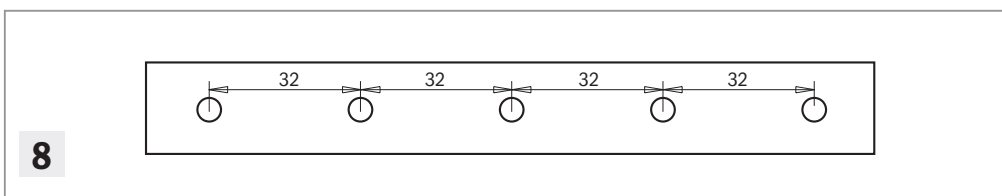

8 Boring head with 5 adaptors for system 32



CMT333-325

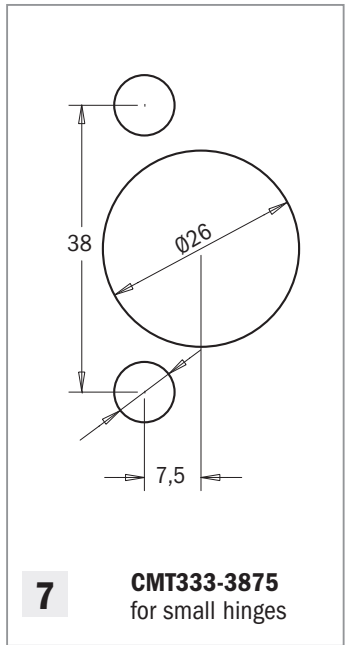
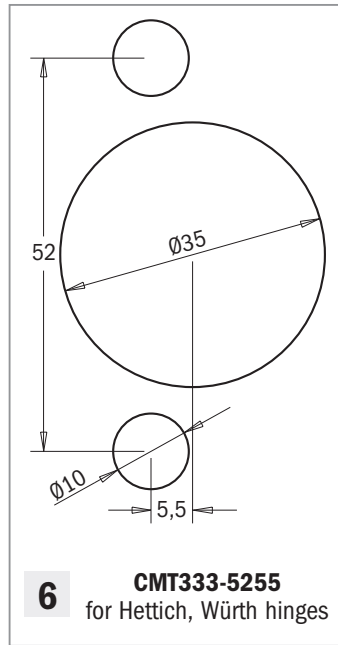
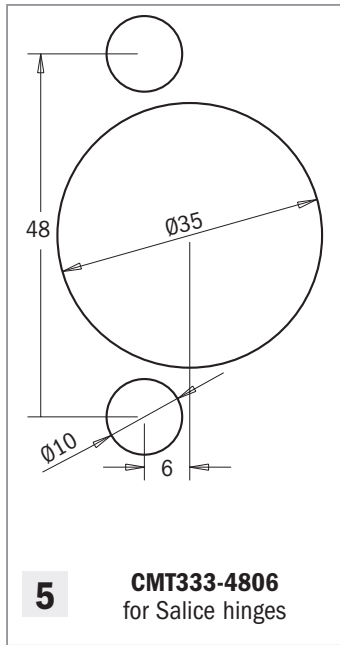
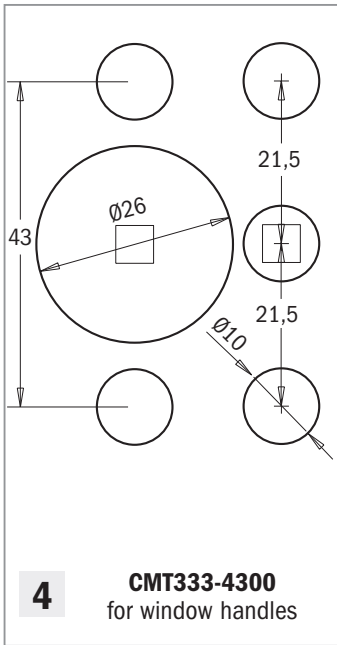
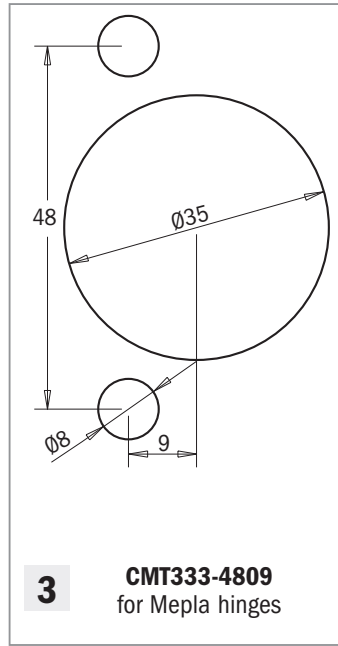
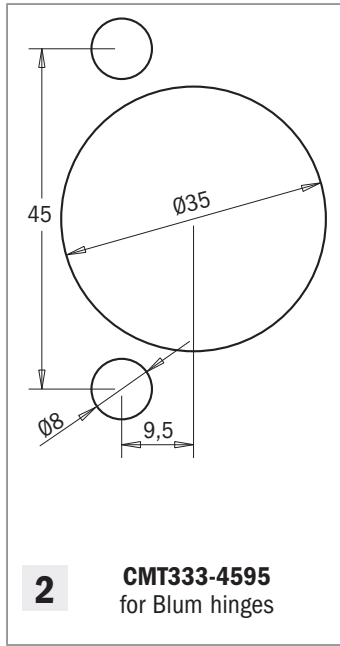
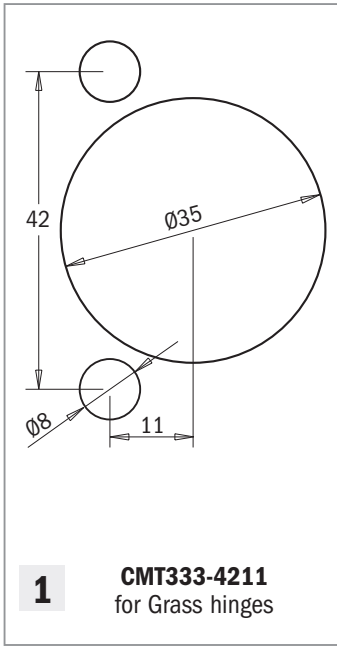

MAXIMUM VERSATILITY FOR ANY BRAND

Make your set

Choose your hinge

1	Grass	42/11
2	Blum	45/9,5
3	Mepla	48/9
4	Window handles	43/00
5	Salice	48/6
6	Hettich, Würth	52/5,5
7	Small hinges	38/7,5
8	System 32	

Support modular base	Boring heads	Drill bits	Boring bit
ORDER NO.	ORDER NO.	ORDER NO. Left-hand rotation	ORDER NO. Right-hand rotation
CMT333	CMT333-4211 Grass	310.080.12 (2 pcs.)	317.350.11
CMT333	CMT333-4595 Blum	310.080.12 (2 pcs.)	317.350.11
CMT333	CMT333-4809 Mepla	310.080.12 (2 pcs.)	317.350.11
CMT333	CMT333-4300 W/handles	310.100.12 (2 pcs.)	317.260.11
CMT333	CMT333-4806 Salice	310.100.12 (2 pcs.)	317.350.11
CMT333	CMT333-5255 Hettich	310.100.12 (2 pcs.)	317.350.11
CMT333	CMT333-3875 Small	(2 pcs.)	317.260.11
CMT333	CMT333-325 System 32	(3 pcs. RH + 2 pcs. LH)	

Blum, Salice, Häfele & Hettich Hinges Boring Head

The innovative CMT334 Universal Hinge Boring Head employs three spindles which allow you to bore the holes for all of the major hinge brands. The head can be utilized on boring and point to point machines.

new

CMT ORANGE TOOLS™

CMT334

Standard

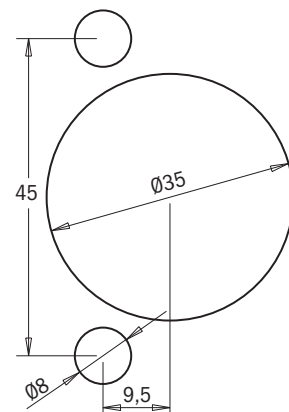

CMT334-4595

for Blum, Salice, Häfele and Hettich hinges 45/9.5



For use on boring and point to point machines



DESCRIPTION	ORDER NO.
Hinge boring head (bits not included)	CMT334-4595
Boring bit Ø35mm x 38,5mm. Right-hand rotation	393.350.11
Dowel Drill Ø8mm x 38,5mm. Left-hand rotation	393.080.12

Double-edge trimmer

new

Attach this trimmer to your workpiece, press both ends against the board for a cutting range between 13mm (1/2") and 25mm (1"), move the trimmer in the correct direction indicated by the arrow. This will cut on both sides easily. The first cutter will cut straight, the second one can be adjusted for a tapering cut. Both cutters are made from high-quality hardened steel and can be easily replaced when worn out.

DET-001



DESCRIPTION	ORDER NO.
Double-edge trimmer	DET-001
<i>Spare parts</i> DET-001K Spare knives for double-edge trimmer	

Formula 2050: blade and bit cleaner



Finally a safe, environmentally-friendly cleaner that is more effective than all those hazardous chemicals used for cleaning cutting tools.

998

Saw shops know how to get the most out of cutting tools. They know that the pitch and resin left by wood on tools greatly shortens the useful life of carbide. Therefore we asked many blade sharpeners to test Formula 2050 and they rated it as an excellent product. Most blade and bit cleaning products work with dissolving action, but it takes some power and nasty chemicals to dissolve wood residues and adhesives. CMT's non-toxic and safe Formula 2050 penetrates the microscopic cracks in the resin and attacks the bond between carbide or steel surfaces and the resin itself. Formula 2050 keeps your tools clean and helps you increase the life span between sharpening and replacement.



12 spray bottles 0,500 lt (18 oz.) in merchandising display



- Removes pitch, resin and adhesive residue from all woodworking cutting tools (saw blades, router bits, drill bits, shaper cutters, planer blades, etc.).
- Do not rinse after cleaning. Formula 2050 provides protection from rust and corrosion. Keeps your table saw top rust free too!
- Completely non-toxic, non-flammable and certified biodegradable. Formula 2050 is a safe, earth-friendly product.
- Can be applied by spray bottle or used in ultrasonic cleaners and dip tanks.

★★★★★ This product received a five-star performance rating from "Wood Magazine"

DESCRIPTION	ORDER NO.
0,500 lt. spray bottle	998.001.01
3,780 lt. plastic jug	998.001.03
12 spray bottles 0,500 lt (18 oz.) in merchandising display	998.001.01-X12
Empty merchandising display (suitable for 12 spray bottles)	998-DIS

Lubricant for wood, Neutralizes resin

- Neutralizes resin, preventing it from being stuck on chips and sawdust.
- Cleans knobs, barbell handles, etc.
- Anti-corrosion action on woodworking machine table.
- Excellent against humidity.

Instruction:
Spray or apply the product on the desired parts of your woodworking machine. You will obtain a uniform layer on its surface that will aid in the sliding of your workpiece.

998

FLAMMABLE PRODUCT.
AIR FREIGHT IS NOT ALLOWED.



DESCRIPTION	ORDER NO.
1 lt. spray bottle (master packaging 12 bottles)	998.002.01
5 lt. plastic jug	998.002.03

CMT900

For dowelling into a surface

For shelf supports

For hinges

Universal boring template

CMT's universal boring template has been designed for precise and productive manual dowelling of furniture elements by using 32mm Euro-System screws, for boring shelf supports with 3mm or 5mm in diameter and for making and marking hinge holes.

By using this template you can prebore the most popular hinge types and also to bore holes for pivots, wooden screws and hinges on the base element, as well as prebore door hinges, included the marking of holes featuring 35mm in diameter for hinges.

This template will guarantee high precision work and productivity and has been designed to be used in pair with the specific CMT400-1 boring adaptor supporting any Ø8mm shank drill bits featuring different diametres.

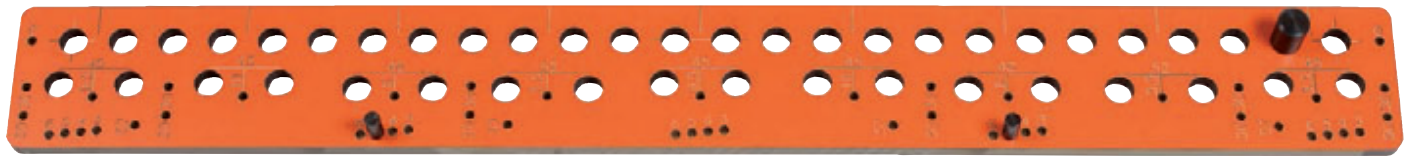

Laminated phenolic material

Clear and comprehensible template marking

Precise end stops

QUICK AND EASY:

Technical data:	CMT900
Max. board width in one tightening:	900mm
Max board width:	no limits
Board thickness:	no limits
For dowels:	Ø8mm
Hole distance:	32mm
Number of holes:	26
For shelf support:	Ø3mm, Ø5mm
For hinges:	Ø3mm for wooden screws Ø5mm for Euro screws

Boring into a surface for dowel joints using the template.

Boring Ø3mm and Ø5mm holes for shelf supports.

Preboring holes for hinges (base and panel).

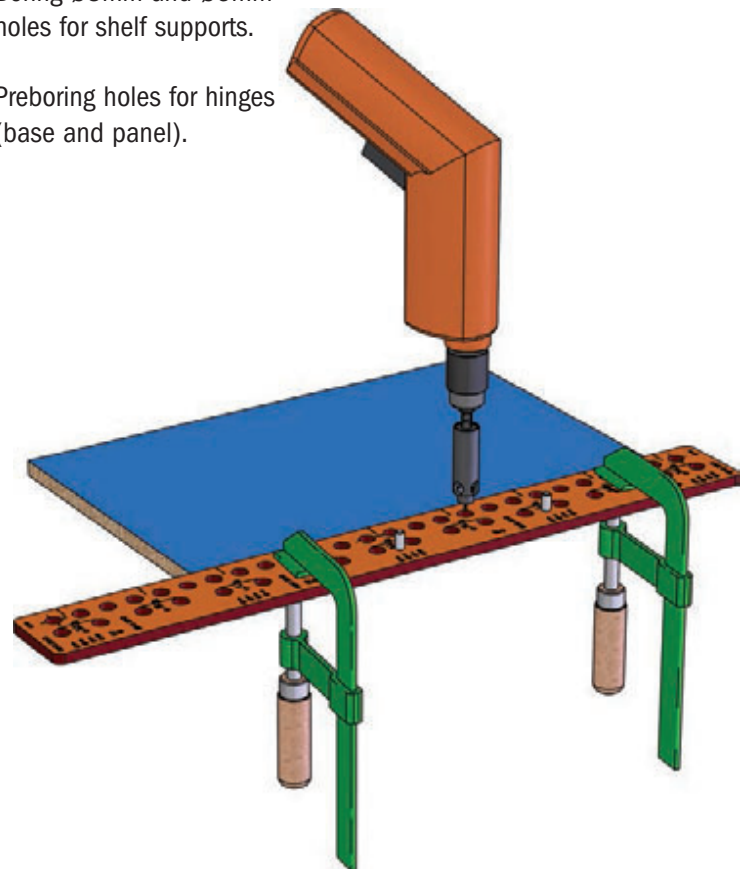

BORING ADAPTORS (not included):

- End stop for different boring depths
- Suitable for any type of drilling machine
- Duralumin body with holes for better chip ejection
- Precise and flat seating for proper alignment.

ORDER NO. **CMT400-1**

Boring adaptor for **CMT656, CMT900 JIGS** to be used with drill bits up to 30mm depth:
306.030.21 - 306.050.11 - 306.080.11



HW DOWEL BITS (not included):

DESCRIPTION	ORDER NO.
D=3x18mm S=8x20mm HWM	306.030.21
D=5x30mm S=8x20mm HW	306.050.11
D=8x30mm S=8x20mm HW	306.080.11



Other sizes available in 306-307 series

CMT900 boring template includes:

- Boring template from laminated pertinax
- End stop set
- End stop set for large elements
- Centring pin for hinges

DESCRIPTION	ORDER NO.
Universal boring template	CMT900

This universal boring jig has been designed for precise and productive manual dowelling of furniture elements and guarantees high precision work and productivity. The holes have been made with a distance of 32mm between one another, in compliance with the European regulations for doweling machine production. Also, the dowel jig fits CMT Ø8mm shank HW drill bits, clamped into a special boring adaptor.

CMT656

For edge dowelling and jointing

Precise holes

Detachable end stops

Ergonomic manual tighteners

Precise and flat duralumin profile

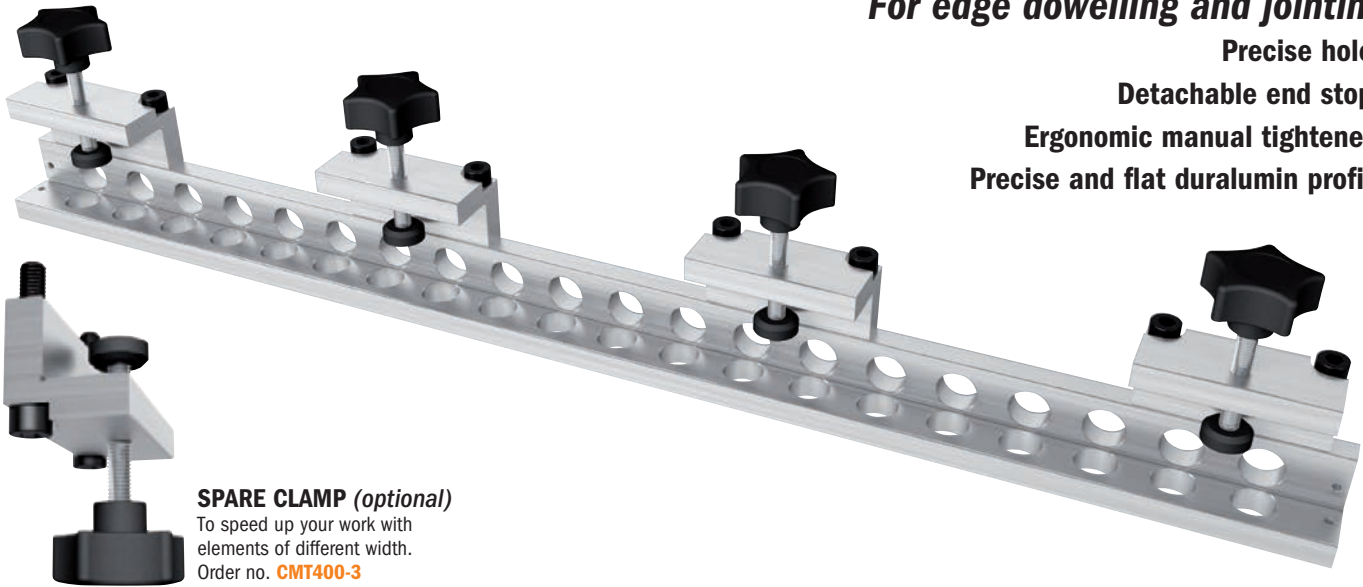

SPARE CLAMP (optional)

To speed up your work with elements of different width.
Order no. **CMT400-3**

UNIQUE SOLUTION

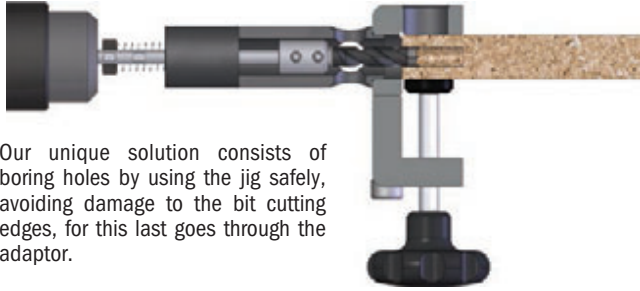

Our unique solution consists of boring holes by using the jig safely, avoiding damage to the bit cutting edges, for this last goes through the adaptor.

BORING ADAPTORS (not included):

- End stop for different boring depths
- Suitable for any type of drilling machine
- Duralumin body with holes for better chip ejection
- Precise and flat seating for properly alignment.

ORDER NO. **CMT400-1**

Boring adaptor for **CMT656, CMT900 JIGS**

to use with the drill bit:

306.030.21 - 306.050.11 - 306.080.11 - 307.050.11

ORDER NO. **CMT400-2** (for screw joints)

Boring adaptor for **CMT656, CMT900 JIGS**

to use with the drill bit: 307.050.11

HW DOWEL BITS (not included):

DESCRIPTION			ORDER NO.
D=3x18mm	S=8x20mm	HWM	306.030.21
D=5x30mm	S=8x20mm	HW	306.050.11
D=8x30mm	S=8x20mm	HW	306.080.11
D=5x40mm	S=8x20mm	HW	307.050.11 for screw joints
D=7x40mm	S=8x20mm	HW	307.070.11 for screw joints

Other sizes available in 306-307 series

TECHNICAL DETAILS:

Max board width in one tightening:	CMT656 656mm
For dowels:	Ø8mm
For through holes:	Ø7mm
Hole distance:	32mm
Number of Ø18mm holes :	2x20
Board thickness:	16-40mm
Facet (elements lap):	0,8mm

3 easy steps for your dowel joints



Place the jig onto the board, fix the end stop and tighten the workpiece. Set the bore depth and clamp the boring adaptor on your drilling machine. Bore vertical holes.



Fasten the jig on the other element, fix the end stop and set the bore depth. Bore horizontal holes.



Now insert the dowels with glue into the holes and join both elements



As an alternative, use through hole bits and screw the elements together.

DESCRIPTION	ORDER NO.
Universal boring jig (656mm in one tightening)	CMT656

Diamond whetstones

For professional, industrial and home users

DSS

FAST: real quality diamond, the hardest known material, reduces the sharpening process.

EASY: stoke the blade across surface with little pressure.

DURABLE: we use natural diamonds for long-lasting performance.

VERSATILE: or sharpening any hard material, steel, glass, ceramic, tungsten carbide, etc.

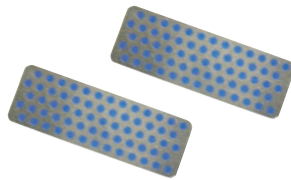
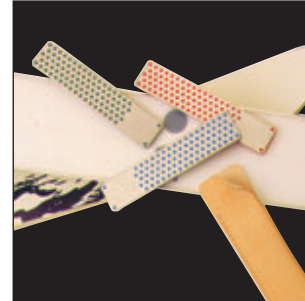

Mini-diamond whetstone in plastic cases

Dimensions mm	Grains	Colour	ORDER NO.
70 x 24 x 2	D15 extrafine	green	DSS-070E
70 x 24 x 2	D25 fine	green	DSS-070F
70 x 24 x 2	D46 coarse	blue	DSS-070M

Until stocks last

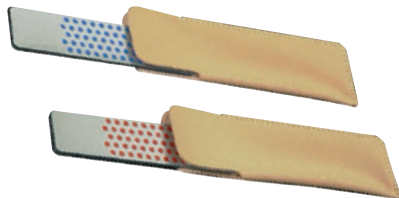

Universal diamond whetstone in leather sheaths

Dimensions mm	Grains	Colour	ORDER NO.
115 x 25 x 3	D15 extrafine	green	DSS-115E
115 x 25 x 3	D25 fine	red	DSS-115F
115 x 25 x 3	D46 coarse	blue	DSS-115M
115 x 25 x 3	D76 extracoarse	black	DSS-115G



Diamond whetstone file

Dimensions mm	Grain	Colour	ORDER NO.
100 Ø4,8	D54 coarse	blue	DSS-048M

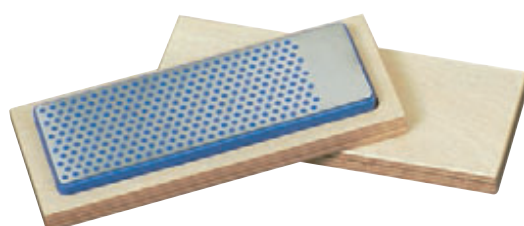

Universal diamond whetstones in hardwood case

Dimensions mm	Grains	Colour	ORDER NO.
150 x 52 x 16	D15 extrafine	green	DSS-150E
150 x 52 x 16	D25 fine	red	DSS-150F
150 x 52 x 16	D46 coarse	blue	DSS-150M
150 x 52 x 16	D76 extracoarse	black	DSS-150G

For sharpening, honing and lapping

- axes
- bayonets
- broadheads
- cable cutters
- carbide cutters
- chainsaws
- chisels
- climbing equipment
- engraving tools
- farm and garden tools
- fish hooks
- Fostner bits
- knives
- lapidary tools
- lawn mower blades
- masonry drills
- moulds and dies
- plane blades
- planer /jointer knives
- pruners
- ring tool
- router bits
- saw blades
- scissors
- shears
- ski and snowboard edges
- small contact area and pointed tools
- speed and hockey skates
- woodcarving scrapers
- woodturning tools

For abrading hard materials

- ceramic
- composites
- fibreglass
- glass
- stainless steel
- stone
- titanium
- tool steel
- tungsten carbide

DSS

For flattening

- chisel backs
- engine heads
- machine bolsters and ways

A unique production process to guarantee a long tool life

A perforated steel plate is moulded onto a strong plastic base by applying high pressure. The steel is then covered with natural diamonds embedded into a nickel plate. The pattern of diamond coating ensures fast sharpening, whereas the plastic indents hold the lubricating water and disperse the fine dust emitted by the diamonds during sharpening.

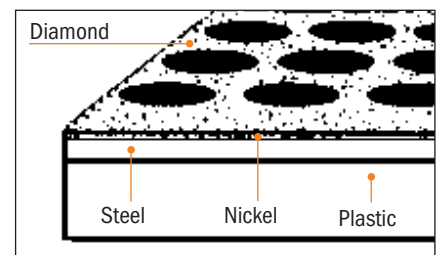

The diamond whetstones are available in four meshes for multiple purposes:

D15 EXTRAFINE/GREEN (9 microns, 1200 mesh)

To refine and polish sharp edges to razor sharp perfection. If you are new to sharpening or need your knife or tool edges as sharp as possible, this grain type is not recommended, but if this suffice, then this is what you are looking for.

D25 FINE/RED (25 microns, 600 mesh)

To restore any slightly dull knife or tool edges to perfect sharpness. Many customers consider the fine grit grain to be suitable to satisfy any working need. Professional chefs and gourmet cooks prefer using this grit grain too. For woodworkers and sportsmen who are stepping through this grit, it is the edge refinement process before micro- refinement and polishing.

D46 COARSE/BLUE (45 microns, 325 mesh)

To quickly restore dull edges to cutting sharp again. Workers who need fast cutting action without caring for edge refinement often use this grit grain.

D76 EXTRA-COARSE/BLACK (60 microns, 220 mesh)

Recommended for aggressive removal of metal on damaged tools or for heavy-duty outdoor tools such as axes and lawn mower blades. Also, this grit grain is commonly used as a first step for flattening the back of chisel and plane irons or for rapid stock removal from chipped or badly damaged edges.

Instructions

Use water for lubrication, after use, rinse and store dry.

1. Keep your knife with cutting edge away from you.

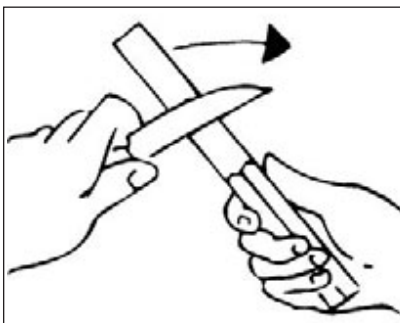

2. Apply some water to the stone surface. Hold blade 20° to diamond surface.

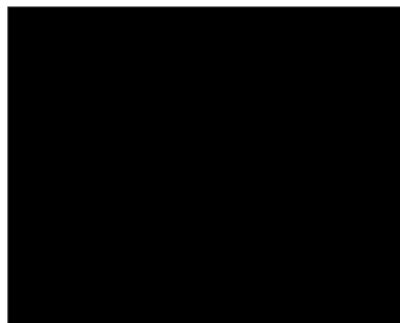

3. With little pressure and in long strokes push the blade across surface. From edge heel to edge tip, alternately on both sides. For pointed tools. Use the unperforated diamond area.

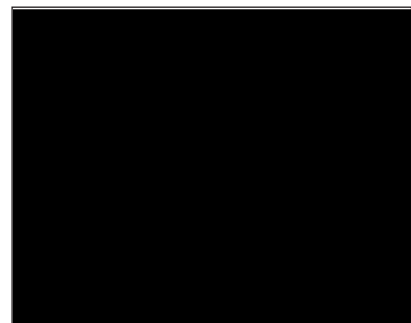

Flexible templates for curved and arched routing



TMP

The CMT flexible template is easy to screw on any kind of wooden panels, MDF or chipboard for creating forms, arcs and curved elements easily and rapidly. In order to fix your template you can use countersunk screws, which are widely available on the market. The CMT template is made of a highly-resistant flexible plastic, which can be tied in knots without any risk of ruining or reducing flexibility.

Screw your template to the edge of the panel and follow its shape and rout the border on the guide ring. The template is suitable for manual feed on routers, router tables and spindle moulders. Rout easily, safely and accurately to make multiple forms such as arcs, curved elements and cut-out forms. Mark the edge of your form precisely and screw it onto a previously-placed panel from underneath.

If you rout with a guide ring mounted onto your spindle moulder, keep your hands a safe distance behind the template. Two different profiles in three lengths are available. Please notice that the smallest profile features a short radius, whereas the larger profile features a larger opening in case of flat and long curves.

TECHNICAL SPECIFICATIONS:

- Special plastic without any plasticizer.
- Made in Germany.
- Lasts more than 10 years!

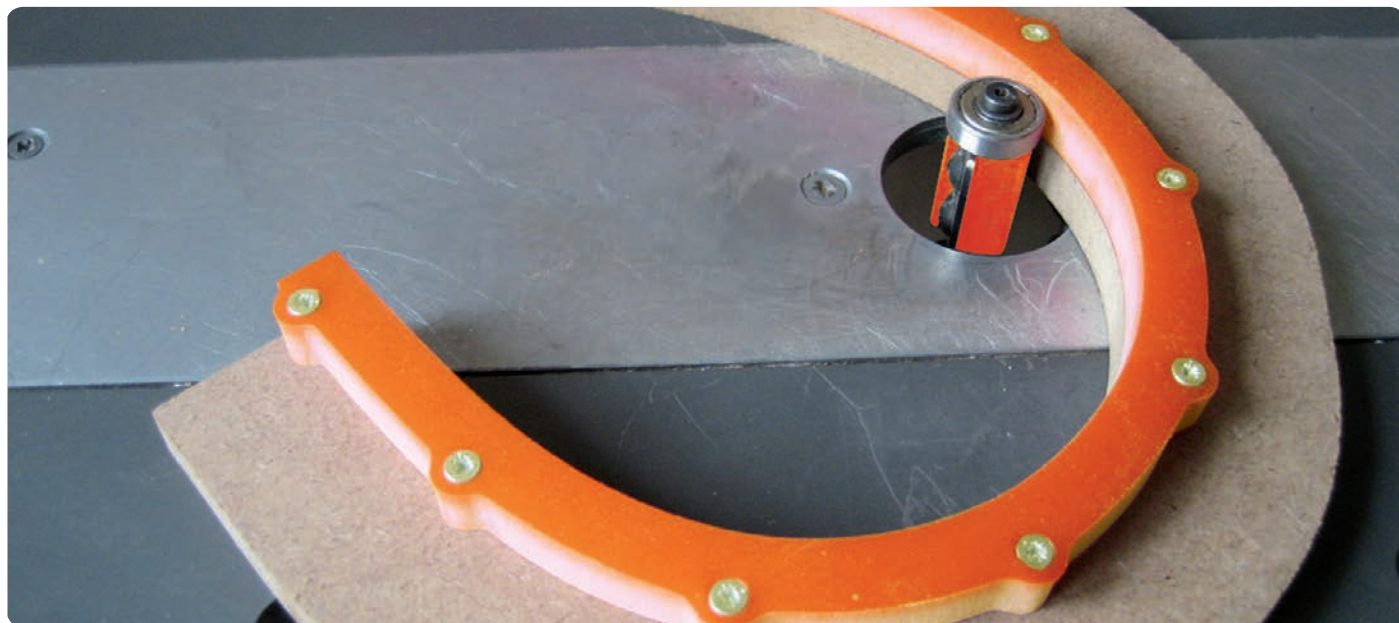

	DESCRIPTION	ORDER NO.
	Flexible template for routing 18x18mm L=1000mm	TMP-1000
	Flexible template for routing 12x12mm L=1200mm	TMP-1200
	Flexible template for routing 18x18mm L=2000mm	TMP-2000

Bowl & tray system

new

CMT ORANGE TOOLS™

BTS-002

CMT System BTS-002 provides a fun and easy way for you to make divided bowls and trays in your shop. No lathe? No problem. This bowl making technique uses a router and CMT's unique bowl and tray router bit. The resulting bowls and trays are beautiful, and will leave your friends astonished! This kit also provides an excellent way to use up scrap wood. Glue pieces together, butcher block style, to make a beautiful pattern of colors and species.

The templates will withstand a lifetime of use and can be used to make more than just one style of bowl or tray. So, with a little imagination, you can make a variety of shapes and styles of bowls and trays. The collet extension, used to make extra deep bowls, is also useful whenever your general woodworking requires extra deep cuts.



TMP-012
MDF Template



TMP-011
MDF Template



DESCRIPTION	ORDER NO. S=Ø12mm
Bowl & tray system	BTS-002
<i>The kit includes</i>	
Router Bit	951.502.11B
Router Collet Extension	796.002.00
MDF Template nr. 1	TMP-011
MDF Template nr. 2	TMP-012
instruction manual	



Trace the templates onto the bowl blank.



Rough out the interior using a drill press and a 50,8mm Forstner bit.



Rout the interior to final shape using the bowl and tray router bit and collet extension.



Bandsaw the exterior to final shape.

Optional



TMP-101
MDF Template
400x400mm.



TMP-103
MDF Template
400x400mm.



TMP-105
MDF Template
330x300mm.

DAG-001

Digital angle gauge

The digital angle gauge is a mini waterproof digital protractor that provides digital readings between $\pm 180^\circ$ with a resolution of $0,1^\circ$ and auto shut off after 5 minutes. It is small enough to be carried around in a pocket and the LED screen is convenient to read. It incorporates magnets in the base for adhesion to any ferrous surface to accurately measure mitre and bevel angles on mitre saws, saw benches, etc.



- TECHNICAL DETAILS:**
- battery voltage/type
3V/L lithium;
 - 51x51x33mm size;
 - $\pm 180^\circ$ range;
 - $0,1^\circ$ resolution.

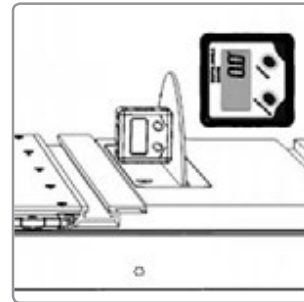
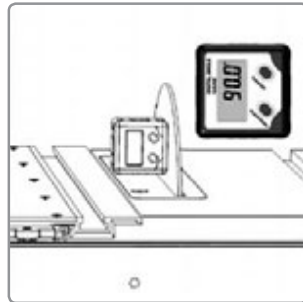
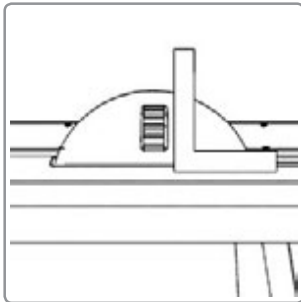
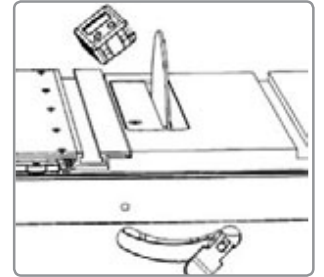
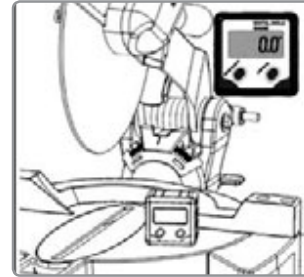

DESCRIPTION

ORDER NO.

Digital angle gauge

DAG-001

Digital angle finder

DAF-001

This digital angle finder is a multi-functional tool for many measuring applications. Easy to operate the base unit carries the electronics giving a very clear detailed LCD display as well as a pair of levelling vials and a pivoting measuring arm. When the arm is extended the angle it makes with the base is indicated clearly on digital read-out to the nearest $0,05^\circ$. The measuring range is $0 - 360^\circ$. The vials allow variations from the vertical and the horizontal to be accurately measured. Other features include a lock function to prevent the last measurement being lost, a low battery indicator and automatic shut off function. Being robust but light in weight this is a very well thought out tool with a lot of uses. Instructions included.

- Easy and simple to use;
- Calculates angles in seconds;
- Large detailed LCD display;
- Robust, lightweight aluminium construction;
- $0 - 360^\circ$ measuring range.

- TECHNICAL DETAILS:**
- 265x50x25mm size;
 - $\pm 0 - 360^\circ$ range;
 - $0,05^\circ$ resolution.

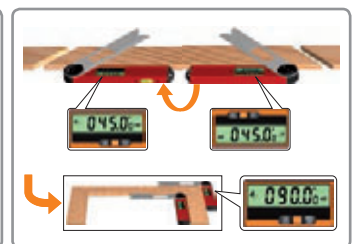
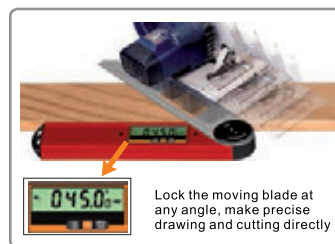
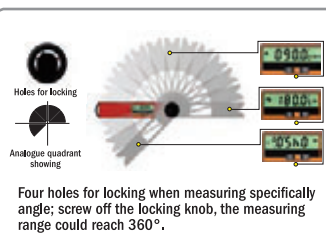
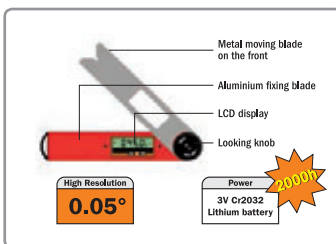

DESCRIPTION

ORDER NO.

Digital angle finder

DAF-001



Horizontal and vertical measuring.

Self-standing for setting cutting depth on router tables and low profiles for backfence adjustment.

Measuring ruler with metric/imperial scale and locking screw.

Instruction manual.

TECHNICAL DETAILS :

- Measuring range: Scale: 0~80mm (0~3")
Needle: 0~50mm (0~2").
- Resolution: 0.05mm/0.002".
- Accuracy: ±0.1mm (±0.004").
- Power: CR2032 3V - 1500 hours.



Place your gauge on a flat surface and set "0" on the display.

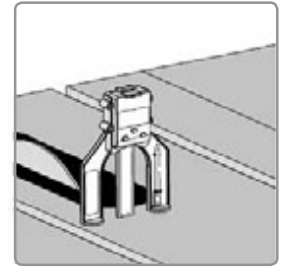
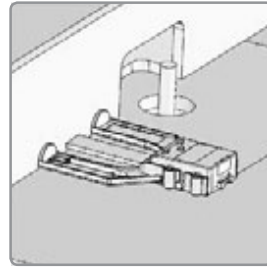
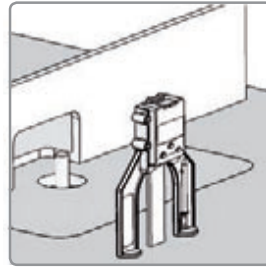

Position your gauge on the tool

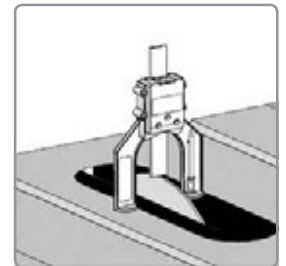
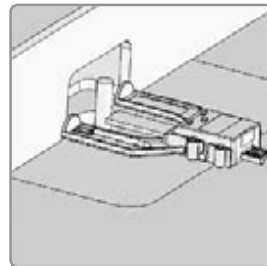
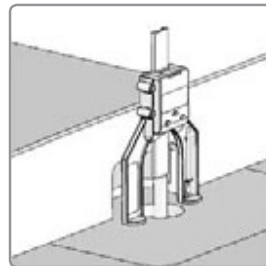

Insert needle and set "0"

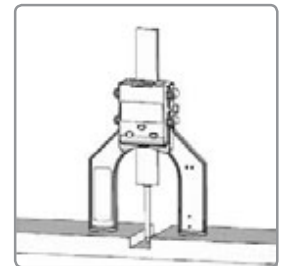
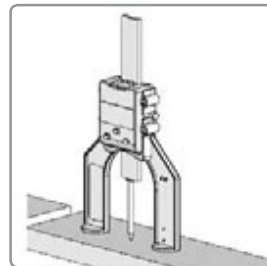

DESCRIPTION	ORDER NO.
Digital height gauge	DHG-001

Display cabinets for router bits / cutter heads / drill bits

This sturdy structure is hand-crafted using wood, tempered glass and iron and is free-standing to offer 360° visibility and to give you the versatility of positioning the display anywhere you like in the store. The front is a convenient 2 component assembly. The two upper sections are designed to display 141 of the best selling router bits from the CMT router bits line and 20 corresponding spare parts; while 10 of the popular wooden box sets can fit perfectly in the lower section if required.

Dimensions are in cm.



The products shown in the images do not correspond to the actual products in the display cabinets (700.300.00L and 900.300.00L)

03.53.0017



Order screws 990.010.00/65 to fix drill bits to the tool holder shelf.

Empty display cabinet for drill bits and toolholder shelf

Start your stock of CMT drill bits now by ordering a convenient cabinet to help you get organized and keep your tools within your hand's reach.

Contact our office for terms and for choosing the drill bits you need from a very broad range.

Dimensions in cm.



DESCRIPTION

ORDER NO.

Display cabinets with: 240 HW router bits (S=Ø6mm), 60 spare parts (saw blades at your choice)	700.300.00L
Display cabinets with: 240 HW router bits (S=Ø8mm), 60 spare parts (saw blades at your choice)	900.300.00L
21 pcs. HW router bits with shank Ø12mm for our display cabinet (optional)	900.021.00
Display cabinet for router bits / cutter heads / drill bits (empty) includes 145 hooks (125 long and 20 short)	03.00.0032
Toolholder shelf for CMT display cabinet 03.00.0032 for drills bits 270x209x1,5cm.	03.53.0017
Long hooks 200mm.	03.53.0010
Short hooks 150mm.	03.53.0011

List of items included in display cabinets



700.300.00L Shank Ø6mm

ORDER NO.	DESCRIPTION	Q.TY	ORDER NO.	DESCRIPTION	Q.TY	ORDER NO.	DESCRIPTION	Q.TY
700.240.00 KIT 240 ROUTER BITS WITH SHANK Ø6MM			714.127.11	Round nose bit	2	748.190.11	Roman ogee bit	2
701.127.11	Mortising bit	2	714.160.11	Round nose bit	2	748.190.11B	Roman ogee bit w/bearing	2
701.160.11	Mortising bit	2	714.190.11	Round nose bit	2	749.001.11	60° Lettering bit	2
701.190.11	Mortising bit	2	714.190.11B	Round nose bit	2	750.001.11	Keyhole bit	2
701.190.11B	Mortising bit	2	715.060.11	V-Grooving bit (90°)	2	751.002.11	Bowl and tray bit	2
703.240.11	Chamfer bit	2	715.095.11	V-Grooving bit (90°)	2	751.002.11B	Bowl and tray bit	2
704.240.11	Chamfer bit	2	715.127.11	V-Grooving bit (90°)	2	753.001.11	Flush and V-groove bit	2
705.240.11	Chamfer bit	2	715.190.11	V-Grooving bit (90°)	2	754.002.11	Bull nose bit	2
706.095.11	Flush trim bit w/bearing	2	715.190.11B	V-Grooving bit (90°)	2	754.003.11	Bull nose bit	2
706.096.11	Flush trim bit w/bearing	2	716.060.11	Panel pilot bit	2	754.004.11	Bull nose bit	2
706.127.11	Flush trim bit w/bearing	2	716.061.11	Panel pilot bit	2			
706.128.11	Flush trim bit w/bearing	2	718.095.11	Dovetail bit	2	758.001.11	Laser point bit (60°)	2
706.190.11	Flush trim bit w/bearing	2	718.127.11	Dovetail bit	2	759.040.11	Roman ogee bit w/bearing	2
707.210.11	Combination flush and bevel trim bit	2	718.158.11	Dovetail bit	2	759.064.11	Roman ogee bit w/bearing	2
709.260.11	Bevel trim and chamfer bit	2	718.190.11	Dovetail bit	2	760.040.11	Roman ogee bit w/bearing	2
710.260.11	Bevel trim and chamfer bit	2	721.030.11	Combination trimmer bit	2	760.064.11	Roman ogee bit w/bearing	2
711.020.11	Straight bit	2	724.060.10	Slot cutter arbor	2	796.000.00	Collet chuck	2
711.030.11	Straight bit	2	727.040.11	Ovolo bit	2	796.560.00	Collet	2
711.040.11	Straight bit	2	727.050.11	Ovolo bit	2	796.580.00	Collet	2
711.050.11	Straight bit	2	727.060.11	Ovolo bit	2	796.595.00	Collet	2
711.060.11	Straight bit	2	727.080.11	Ovolo bit	2	822.320.11	Slot cutter	2
711.070.11	Straight bit	2	727.095.11	Ovolo bit	2	822.325.11	Slot cutter	2
711.080.11	Straight bit	2	735.317.11	Rabbeting bit w/bearing	2	822.330.11	Slot cutter	2
711.090.11	Straight bit	2	736.130.11	Chamfer bit w/bearing	2	822.335.11	Slot cutter	2
711.100.11	Straight bit	2	736.190.11	Chamfer bit w/bearing	2	822.340.11	Slot cutter	2
711.110.11	Straight bit	2	736.280.11	Chamfer bit w/bearing	2	822.350.11	Slot cutter	2
711.120.11	Straight bit	2	736.420.11	Chamfer bit w/bearing	2	822.360.11	Slot cutter	2
711.130.11	Straight bit	2	737.190.11	Round nose bit w/bearing	2			
711.130.11B	Straight bit	2	737.222.11	Round nose bit w/bearing	2	900.060.00 KIT WITH 60 SPARE PARTS		
711.140.11	Straight bit	2	737.254.11	Round nose bit w/bearing	2	541.003.00	Stop collar for top bearing bit	3
711.150.11	Straight bit	2	737.286.11	Round nose bit w/bearing	2	541.004.00	Stop collar for top bearing bit	3
711.150.11B	Straight bit	2	737.350.11	Round nose bit w/bearing	2	791.002.00	Bearing	3
711.160.11	Straight bit	2	738.160.11	Ovolo bit w/bearing	2	791.003.00	Bearing	3
711.180.11	Straight bit	2	738.190.11	Ovolo bit w/bearing	2	791.004.00	Bearing	3
711.190.11	Straight bit	2	738.222.11	Ovolo bit w/bearing	2	791.006.00	Bearing	3
711.190.11B	Straight bit	2	738.254.11	Ovolo bit w/bearing	2	791.007.00	Bearing	3
711.200.11	Straight bit	2	738.285.11	Ovolo bit w/bearing	2	791.012.00	Bearing	3
711.220.11	Straight bit	2	738.317.11	Ovolo bit w/bearing	2	791.018.00	Bearing	3
711.240.11	Straight bit	2	738.380.11	Ovolo bit w/bearing	2	791.023.00	Bearing	3
711.250.11	Straight bit	2	740.270.11	Roman ogee bit w/bearing	2	791.024.00	Bearing	3
712.060.11	Straight bit	2	740.350.11	Roman ogee bit w/bearing	2	791.025.00	Bearing	3
712.080.11	Straight bit	2	741.285.11	Roman ogee bit w/bearing	2	799.060.00	Bushing	3
712.100.11	Straight bit	2	741.380.11	Roman ogee bit w/bearing	2	990.004.00	Bearing screw	3
712.120.11	Straight bit	2	744.287.11	Roman ogee bit w/bearing	2	990.005.00	Bearing screw	3
712.150.11B	Straight bit	2	744.350.11	Roman ogee bit w/bearing	2	990.058.00	Bearing screw	3
712.160.11	Straight bit	2	745.287.11	Roman ogee bit w/bearing	2	990.059.00	Bearing screw	3
714.032.11	Round nose bit	2	745.350.11	Roman ogee bit w/bearing	2	991.056.00	Hex key for bearing screw	3
714.060.11	Round nose bit	2	746.325.11	Roman ogee bit w/bearing	2	991.057.00	Hex key for bearing screw	3
714.095.11	Round nose bit	2	747.325.11	Roman ogee bit w/bearing	2	991.062.00	Hex key for bearing screw	3

900.300.00L Shank Ø8mm

ORDER NO.	DESCRIPTION	Q.TY	ORDER NO.	DESCRIPTION	Q.TY	ORDER NO.	DESCRIPTION	Q.TY
900.240.00 KIT 240 ROUTER BITS WITH SHANK Ø8MM			914.160.11	Round nose bit	2	945.350.11	Roman ogee bit w/bearing	2
901.127.11	Mortising bit	2	914.160.11B	Round nose bit w/bearing	2	946.325.11	Roman ogee bit w/bearing	2
901.160.11	Mortising bit	2	914.190.11	Round nose bit	2	947.325.11	Roman ogee bit w/bearing	2
901.160.11B	Mortising bit w/bearing	2	915.060.11	V-Grooving bit (90°)	2	948.190.11	Roman ogee bit	2
901.180.11	Mortising bit	2	915.095.11	V-Grooving bit (90°)	2	950.001.11	Keyhole bit	2
901.190.11	Mortising bit	2	915.127.11	V-Grooving bit (90°)	2	951.002.11	Bowl and tray bit	2
901.200.11	Mortising bit	2	915.160.11	V-Grooving bit (90°)	2	953.001.11	Flush and V-groove w/bearing	2
903.240.11	Chamfer bit	2	915.160.11B	V-Grooving bit (90°) w/bearing	2	954.002.11	Bull nose bit	2
904.240.11	Chamfer bit	2	916.080.11	Panel pilot bit	2	954.003.11	Bull nose bit	2
905.240.11	Chamfer bit	2	918.095.11	Dovetail bit	2	954.004.11	Bull nose bit	2
906.095.11	Flush trim bit w/bearing	2	918.127.11	Dovetail bit	2	958.001.11	Laser point bit (60°)	2
906.096.11	Flush trim bit w/bearing	2	918.158.11	Dovetail bit	2	959.040.11	Roman ogee bit w/bearing	2
906.127.11	Flush trim bit w/bearing	2	918.190.11	Dovetail bit	2	959.064.11	Roman ogee bit w/bearing	2
906.128.11	Flush trim bit w/bearing	2	921.030.11	Combination trimmer bit	2	960.040.11	Roman ogee bit w/bearing	2
906.190.11	Flush trim bit w/bearing	2	924.080.00	Slot cutter arbor	2	960.064.11	Roman ogee bit w/bearing	2
907.210.11	Combination flush and bevel trim bit	2	924.080.10	Slot cutter arbors w/bearing	2	796.000.00	Collet chuck	2
909.260.11	Bevel trim and chamfer bit w/bearing	2	927.040.11	Ovolo bit	2	796.560.00	Collet	2
910.260.11	Bevel trim and chamfer bit w/bearing	2	927.050.11	Ovolo bit	2	796.580.00	Collet	2
911.030.11	Straight bit	2	927.060.11	Ovolo bit	2	796.595.00	Collet	2
911.040.11	Straight bit	2	927.080.11	Ovolo bit	2	822.320.11	Slot cutter	2
911.050.11	Straight bit	2	927.095.11	Ovolo bit	2	822.325.11	Slot cutter	2
911.060.11	Straight bit	2	935.001.11	Rabbeting bit w/bearing	2	822.330.11	Slot cutter	2
911.070.11	Straight bit	2	935.317.11	Rabbeting bit w/bearing	2	822.335.11	Slot cutter	2
911.080.11	Straight bit	2	935.350.11	Rabbeting bit w/bearing	2	822.340.11	Slot cutter	2
911.090.11	Straight bit	2	935.502.11	Rabbeting set w/bearing	2	822.350.11	Slot cutter	2
911.100.11	Straight bit	2	936.130.11	Chamfer bit w/bearing	2	822.360.11	Slot cutter	2
911.120.11	Straight bit	2	936.190.11	Chamfer bit w/bearing	2			
911.140.11	Straight bit	2	936.280.11	Chamfer bit w/bearing	2	900.060.00 KIT WITH 60 SPARE PARTS		
911.150.11	Straight bit	2	936.420.11	Chamfer bit w/bearing	2	541.003.00	Stop collar for top bearing bit	3
911.160.11	Straight bit	2	937.190.11	Round nose bit w/bearing	2	541.004.00	Stop collar for top bearing bit	3
911.160.11B	Straight bit w/bearing	2	937.222.11	Round nose bit w/bearing	2	791.002.00	Bearing	3
911.180.11	Straight bit	2	937.254.11	Round nose bit w/bearing	2	791.003.00	Bearing	3
911.200.11	Straight bit	2	937.286.11	Round nose bit w/bearing	2	791.004.00	Bearing	3
911.220.11	Straight bit	2	937.350.11	Round nose bit w/bearing	2	791.006.00	Bearing	3
911.220.11B	Straight bit w/bearing	2	938.160.11	Ovolo bit w/bearing	2	791.007.00	Bearing	3
911.240.11	Straight bit	2	938.190.11	Ovolo bit w/bearing	2	791.012.00	Bearing	3
911.250.11	Straight bit	2	938.222.11	Ovolo bit w/bearing	2	791.018.00	Bearing	3
912.060.11	Straight bit	2	938.254.11	Ovolo bit w/bearing	2	791.023.00	Bearing	3
912.080.11	Straight bit	2	938.285.11	Ovolo bit w/bearing	2	791.024.00	Bearing	3
912.100.11	Straight bit	2	938.317.11	Ovolo bit w/bearing	2	791.025.00	Bearing	3
912.120.11	Straight bit	2	938.380.11	Ovolo bit w/bearing	2	799.060.00	Bushing	3
912.140.11	Straight bit	2	938.445.11	Ovolo bit w/bearing	2	990.004.00	Bearing screw	3
912.150.11	Straight bit	2	940.270.11	Roman ogee bit w/bearing	2	990.005.00	Bearing screw	3
912.160.11	Straight bit	2	940.350.11	Roman ogee bit w/bearing	2	990.058.00	Bearing screw	3
912.160.11B	Straight bit w/bearing	2	941.285.11	Roman ogee bit w/bearing	2	990.059.00	Bearing screw	3
914.032.11	Round nose bit	2	941.380.11	Roman ogee bit w/bearing	2	991.056.00	Hex key for bearing screw	3
914.060.11	Round nose bit	2	944.287.11	Roman ogee bit w/bearing	2	991.057.00	Hex key for bearing screw	3
914.095.11	Round nose bit	2	944.350.11	Roman ogee bit w/bearing	2	991.062.00	Hex key for bearing screw	3
914.127.11	Round nose bit	2	945.287.11	Roman ogee bit w/bearing	2			

900.021.00 Shank Ø12mm

ORDER NO.	DESCRIPTION	Q.TY	ORDER NO.	DESCRIPTION	Q.TY	ORDER NO.	DESCRIPTION	Q.TY
900.506.11	Three wing slot cutter set	1	954.509.11	Bull nose bit	1	956.701.11	Table edge and hand rail bit	1
918.658.11	Dovetail bit	1	955.501.11	Reverse glue joint bit	1	956.801.11	Multiprofile bit with bearing	1
938.990.11	Ovolo bit with bearing	1	955.601.11	Finger pull bit	1	956.802.11	Multiprofile bit with bearing	1
938.991.11	Ovolo bit with bearing	1	955.901.11	Molding bit with bearing	1	956.851.11	CMT molding system	1
938.992.11	Ovolo bit with bearing	1	955.902.11	Molding bit with bearing	1	956.852.11	CMT molding system	1
938.993.11	Ovolo bit with bearing	1	956.501.11	Molding bit with bearing	1	990.501.11	Raised panel bit	1
954.507.11	Bull nose bit	1	956.601.11	Table edge and hand rail bit	1	991.501.11	Rail & Stile set	1

Display cabinets for router bits / cutter heads / Forstner bits

7/900.084.00

A beautiful, well-organized display of router bits in your shop is the best way to encourage customers to buy. CMT has produced this beautiful cabinet to best show off our wide selection of high quality bright orange bits. Made with a sturdy hardwood frame and three glass panels, it is the ideal counter-top display. Holds 42 of our most popular router bits and spare parts - 2 pcs. each for 84 pcs. total or 3 pcs. each for 126 pcs. total. The wooden slat back wall allows for easy bit organization and comes standard with front door lock. The cabinet is available with router bits with 6mm and 8mm shanks.

Dimensions are in cm.



Suitable for boring and Forstner Bits
(at your choice)



Suitable for cutter heads
(at your choice)

700.084.00 Shank Ø6mm

ORDER NO.	DESCRIPTION	Q.TY
701.190.11	Mortising bit	2
706.096.11	Flush trim bit w/bearing	2
706.127.11	Flush trim bit w/bearing	2
706.190.11	Flush trim bit w/bearing	2
711.030.11	Straight bit	2
711.040.11	Straight bit	2
711.050.11	Straight bit	2
711.060.11	Straight bit	2
711.080.11	Straight bit	2
711.100.11	Straight bit	2
711.120.11	Straight bit	2
711.160.11	Straight bit	2
711.200.11	Straight bit	2
712.060.11	Straight bit	2
712.120.11	Straight bit	2
714.060.11	Round nose bit	2
714.095.11	Round nose bit	2
715.060.11	V-Grooving bit (90°)	2
715.127.11	V-Grooving bit (90°)	2
716.060.11	Panel pilot bit	2
718.127.11	Dovetail bit	2
727.060.11	Ovolo bit	2
735.317.11	Rabbeting bit w/bearing	2
736.190.11	Chamfer bit w/bearing	2
736.280.11	Chamfer bit w/bearing	2
737.222.11	Round nose bit w/bearing	2
737.286.11	Round nose bit w/bearing	2
737.350.11	Round nose bit w/bearing	2
738.254.11	Ovolo bit w/bearing	2
738.317.11	Ovolo bit w/bearing	2
738.380.11	Ovolo bit w/bearing	2
740.270.11	Roman ogee bit w/bearing	2
741.285.11	Roman ogee bit w/bearing	2
744.287.11	Roman ogee bit w/bearing	2
746.325.11	Roman ogee bit w/bearing	2
748.190.11	Roman ogee bit	2
754.003.11	Bull nose bit	2
759.040.11	Roman ogee bit w/bearing	2
791.002.00	Bearing	2
791.003.00	Bearing	2
990.058.00	Bearing screw	2
991.057.00	Hex key for bearing screw	2

900.084.00 Shank Ø8mm

ORDER NO.	DESCRIPTION	Q.TY
901.190.11	Mortising bit	2
906.096.11	Flush trim bit w/bearing	2
906.127.11	Flush trim bit w/bearing	2
906.190.11	Flush trim bit w/bearing	2
911.030.11	Straight bit	2
911.040.11	Straight bit	2
911.050.11	Straight bit	2
911.060.11	Straight bit	2
911.080.11	Straight bit	2
911.100.11	Straight bit	2
911.120.11	Straight bit	2
911.160.11	Straight bit	2
911.200.11	Straight bit	2
912.060.11	Straight bit	2
912.120.11	Straight bit	2
914.060.11	Round nose bit	2
914.095.11	Round nose bit	2
915.060.11	V-Grooving bit (90°)	2
915.127.11	V-Grooving bit (90°)	2
916.080.11	Panel pilot bit	2
918.127.11	Dovetail bit	2
927.060.11	Ovolo bit	2
935.317.11	Rabbeting bit w/bearing	2
936.190.11	Chamfer bit w/bearing	2
936.280.11	Chamfer bit w/bearing	2
937.222.11	Round nose bit w/bearing	2
937.286.11	Round nose bit w/bearing	2
937.350.11	Round nose bit w/bearing	2
938.254.11	Ovolo bit w/bearing	2
938.317.11	Ovolo bit w/bearing	2
938.380.11	Ovolo bit w/bearing	2
940.270.11	Roman ogee bit w/bearing	2
941.285.11	Roman ogee bit w/bearing	2
944.287.11	Roman ogee bit w/bearing	2
946.325.11	Roman ogee bit w/bearing	2
948.190.11	Roman ogee bit	2
954.003.11	Bull nose bit	2
959.040.11	Roman ogee bit w/bearing	2
791.002.00	Bearing	2
791.003.00	Bearing	2
990.058.00	Bearing screw	2
991.057.00	Hex key for bearing screw	2

DESCRIPTION	ORDER NO.
Display cabinet with: 76 HW Router bits (S=Ø6mm), 8 Spare parts (2 pcs. each)	700.084.00
Display cabinet with: 76 HW Router bits (S=Ø8mm), 8 Spare parts (2 pcs. each)	900.084.00
Display cabinet for router bits / cutter heads / Forstner bits (empty) includes 42 short hooks	03.00.0002
Short hooks 150mm.	03.53.0011

Saw blades
Jig saw blades
Tools with bore & Knives
Router bits & sets
CNC router cutter & chucks
Industrial dowel drills
Bits for hand power tools
Power tools & accessories
Display cabinets & spare parts

Display cabinets for saw blades

new

CMT ORANGE TOOLS™

A sturdy steel-made saw blade display cabinet with backlight to place anywhere you want in your store. You can hang up different types of saw blades. Please contact your CMT salesman to get advice on the most suitable saw blade composition to display.

Saw blades are not included.

Dimensions are in cm.

03.00.0038

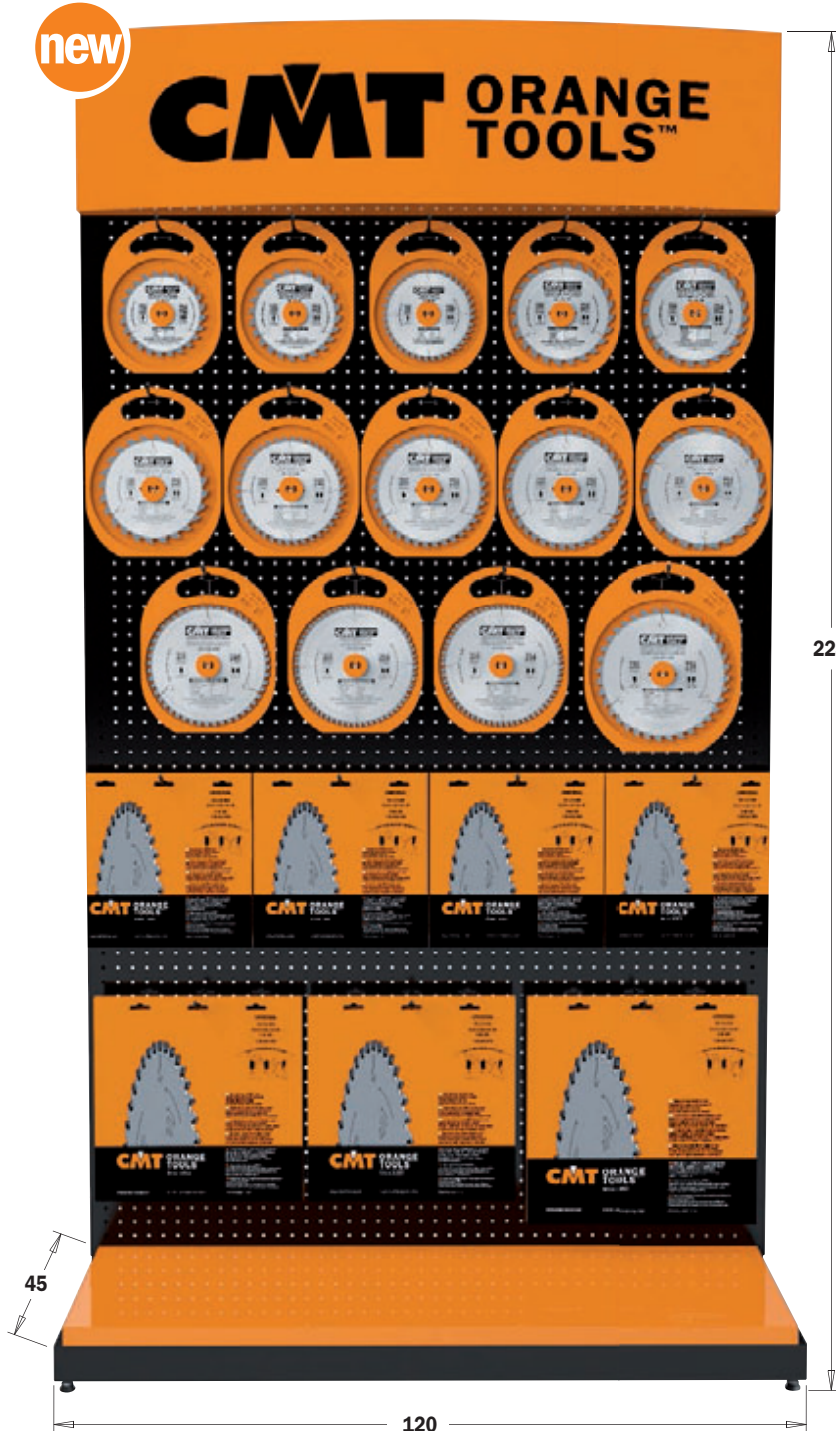

03.00.0030



We also offer a practical wire counter display for saw blades up to Ø350mm.

DESCRIPTION	ORDER NO.
Wire counter display only (empty)	03.00.0030
Display cabinet with backlight (220V) for saw blades (empty) hooks not included, order separately	03.00.0038
Short hooks 150mm.	03.53.0011

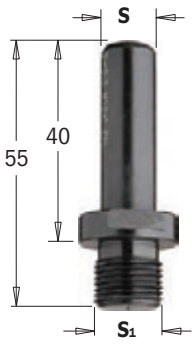
Arbors
797

S mm	S ₁ mm	ORDER NO.
8	M10x1,5	797.580.00
10	M12x1	797.100.00
12	M12x1	797.120.00
12,7	M12x1	797.127.00

TECHNICAL DETAILS:

- Super strength steel.
- Precisely machined for accuracy.

Collet chucks
796

S ₁ mm	D ₃ _For collet diameter mm	L mm	ORDER NO.
M10x1,5	6 - 6,35 - 8 - 9,5	38	796.100.00
M12x1	6 - 6,35 - 8 - 9,5	38	796.000.00
M12x1	10 - 12 - 12,7	47	796.121.00

TECHNICAL DETAILS:

- Super strength steel.
- Precisely machined for accuracy.

Collet not included.

Router chuck extensions with collet
796.001/002

S mm	D ₃ _For collet diameter mm	L mm	ORDER NO.
12	8	81	796.002.01
12	12	88	796.002.00
12,7	6,35	81	796.001.01
12,7	12,7	88	796.001.00

TECHNICAL DETAILS:

- Super strength steel.
- Precisely machined for accuracy.

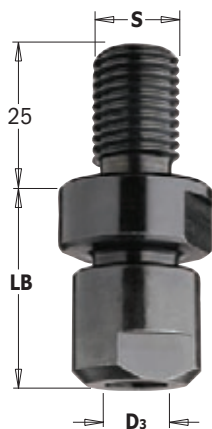
Collet included.

Collet chucks
796

S mm	D ₃ _For collet diameter mm	LB mm	ORDER NO.
M14x2	6 - 6,35 - 8 - 9,5	32	796.140.00
M14x2	10 - 12 - 12,7	38	796.141.00
M16x2	6 - 6,35 - 8 - 9,5	32	796.160.00
M16x2	10 - 12 - 12,7	38	796.161.00

TECHNICAL DETAILS:

- Super strength steel.
- Precisely machined for accuracy.

Collet not included.

Collets
796.500/600

D ₃ mm	ORDER NO.	D ₃ mm	ORDER NO.
6	796.560.00	10	796.600.00
6,35	796.564.00	12	796.620.00
8	796.580.00	12,7	796.627.00
9,5	796.595.00		

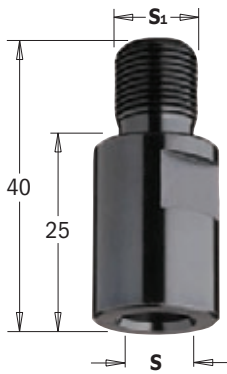

Arbors

798

S mm	S ₁ mm	ORDER NO.
M10x1,5	M10x1,5	798.101.00
M10x1,5	M12x1	798.102.00
M12x1	M10x1,5	798.121.00
M12x1	M12x1	798.122.00

TECHNICAL DETAILS:

- Super strength steel.
- Precisely machined for accuracy.

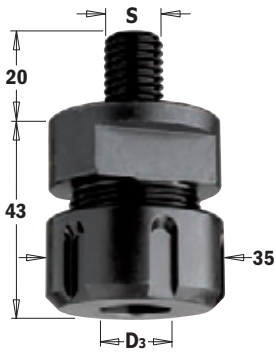

“ER20” chucks

796

S mm	D ₃ _For collet diameter mmmm	LB mm	ORDER NO.
M12x1,75	3 ~ 12,7	43	796.122.00
M14x2	3 ~ 12,7	43	796.142.00
M16x2	3 ~ 12,7	43	796.162.00

Spare parts: 992.483.03 M25x1,5mm clamping nut
991.483.00 “ER20” key

TECHNICAL DETAILS:

Super strength steel. Precisely machined for accuracy.

Collet not included.

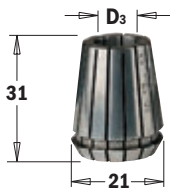

“ER20” precision collets for 796.122/142/162 items

184

D ₃ mm	ORDER NO.	D ₃ mm	ORDER NO.
3	184.030.20	8	184.080.20
5	184.050.20	10	184.100.20
6	184.060.20	12	184.120.20
6,35	184.064.20	12,7	184.127.20

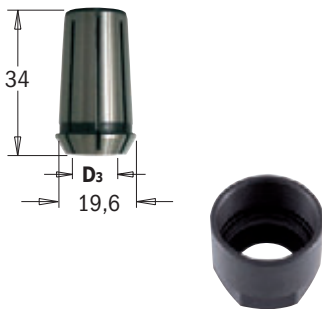

“ER20” precision collets for 796.122/142/162 items

796.8

D ₃ mm	ORDER NO.	D ₃ mm	ORDER NO.
6	796.860.00	10	796.900.00
6,35	796.864.00	12	796.920.00
8	796.880.00	12,7	796.927.00
9,5	796.895.00		

Spare parts: 992.100.01 M22 clamping nut



Collets for CMT1E, CMT2E, DeWalt, Felisatti, Fein, Metabo hand-held routers

796.780

D ₃ mm	L mm	ORDER NO.
8	14	796.780.00



Bushings

799

B mm	D mm	L mm	ORDER NO.	B mm	D mm	L mm	ORDER NO.
6	8	25	799.060.00	8	10	25	799.280.00
6	9,5	25	799.160.00	8	12	25	799.380.00
6	12	25	799.260.00	8	12,7	25	799.480.00
6,35	8	25	799.064.00	9,5	12,7	25	799.001.00
6,35	9,5	25	799.164.00	10	12	25	799.100.00
6,35	12,7	25	799.264.00	13	16	45	799.130.00
8	9,5	25	799.180.00				

Spare part and accessories

Saw blades
Jig saw blades
Tools with bore & Knives
Router bits & sets
CNC router cutter & chucks
Industrial dowel drills
Bits for hand power tools
Power tools & accessories
Display cabinets & spare parts

990

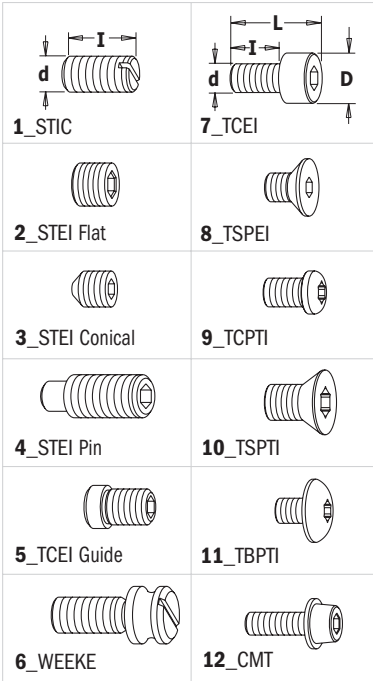

Screws

d x l x L mm	D mm	TIPO	ORDER NO.	d x l x L mm	D mm	TIPO	ORDER NO.
M5x8		1_STIC	990.008.00	M6x25x31	10	7_TCEI	990.098.00
M5x10		1_STIC	990.003.00	M8x25x33	13	7_TCEI	990.099.00
M4x20		2_STEI	990.091.00	1/8"x1/2"x5/8"	5,5	7_TCEI	990.059.00
M5x4		2_STEI	990.015.00	M5x10x15	8,5	7_TCEI	990.010.00
M5x5		2_STEI	990.001.00	M4x3,7x6	8	8_TSPEI	990.004.00
M5x5 p/coppa		2_STEI	990.006.00	M5x9x12	10	8_TSPEI	990.055.00
M3x3		3_STEI	990.005.00	M5x5,2x8	9	8_TSPIC	990.067.00
M5x5		3_STEI	990.002.00	M6x8x10	9	8_TSPEI	990.083.00
M6x6		3_STEI	990.007.00	1/4"x11/16"x7/8"	12	9_TSPEI	990.097.00
M4x3		3_STEI	990.013.00	1/8"x3/8"x1/2"	7	12_TCEI	990.058.00
M4x4		3_STEI	990.014.00	Torx screw			
M6x5		3_STEI	990.009.00	M3x4x5,7	4,6	9_TCPTI	990.082.00
M6x8		4_STEI	990.087.00	M4x4,5x8	7,5	9_TCPTI	990.094.00
M6x16		4_STEI	990.066.00	M5x12x18	6,8	8_TSPEI	990.063.00
M6x20		4_STEI	990.084.00	M2,5x3x4,5	3,5	10_TSPTI	990.070.00
M6x25		4_STEI	990.085.00	M2,5x4,5x6	3,7	10_TSPTI	990.071.00
M8x16		4_STEI	990.064.00	M4x2x3	7,6	10_TSPTI	990.079.00
M8x12		4_STEI	990.065.00	M5x4,75x6,5	9	10_TSPTI	990.080.00
M8x20		4_STEI	990.086.00	M5x5x8	9	10_TSPTI	990.093.00
M5x5x9	6	5_STEI	990.068.00	M3,5x3,5x6	6	11_TBPTI	990.072.00
M5x11,5x17		6_WEEKE	990.088.00	M3,5x5x7,2	8,8	11_TBPTI	990.073.00
M2,5x6x8,5	4,5	7_TCEI	990.062.00	M3,5x6x8,5	6	11_TBPTI	990.077.00
M3x6x9	5,5	7_TCEI	990.051.00	M4x3,5x5,7	8,8	11_TBPTI	990.074.00
M3x10x13	5,5	7_TCEI	990.053.00	M4x4x6,2	9	11_TBPTI	990.056.00
M3x16x19	5,5	7_TCEI	990.054.00	M4x4x6,2	5,8	11_TBPTI	990.076.00
M4x6x10	7	7_TCEI	990.052.00	M4x6x8	6	11_TBPTI	990.078.00
M4x12x16	7	7_TCEI	990.061.00	M4x6x8,2	8,8	11_TBPTI	990.075.00

991

Keys for screws



DESCRIPTION	ORDER NO.	DESCRIPTION	ORDER NO.
Hex keys		6mm	991.066.00
1,5mm (for M3 screws)	991.056.00	Torx key	
2mm	991.060.00	T8	991.063.00
3/32" (for 1/8W screws)	991.057.00	T9	991.069.00
2,5mm (for M4 screws)	991.062.00	T15	991.061.00
3mm	991.067.00	T20	991.072.00
4mm	991.064.00	T25	991.073.00
5mm	991.065.00	T30	991.071.00

990

Shields for bearings



DESCRIPTION	ORDER NO.	DESCRIPTION	ORDER NO.
Ø9,5mm	990.422.00	Ø12,7mm	990.423.00

990.0

Nuts for arbors



DESCRIPTION	ORDER NO.	DESCRIPTION	ORDER NO.
M4	990.092.00	M8	990.020.00
M6	990.095.00	M12x1,25mm	990.022.00

541

Stop collars



B mm	ORDER NO.	B mm	ORDER NO.
6	541.003.00	9,5	541.006.00
6,35	541.001.00	12	541.005.00
8	541.004.00	12,7	541.002.00

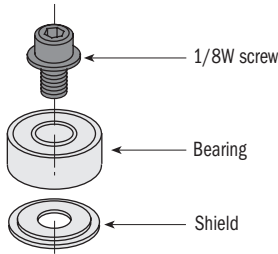

Be Sure: to keep the black washer right side up to correspond with the bearing rotation during reassembly.



***10° Delrin® conical bearing**



****Delrin® triangular bearing**



*****Delrin® cylindrical bearings**

Bearings

D		B		Thickness	ORDER NO.
mm	inches	mm	inches	mm	
6,35	1/4	3,17	1/8	2,8	791.035.00
9,5	3/8	4,76	3/16	3,2	791.002.00
12,7	1/2	4,76	3/16	5	791.003.00
12,7	1/2	6,35	1/4	4,8	791.010.00
13		5		4	791.022.00
13		6		5	791.023.00
15		6		5	791.024.00
15,8	5/8	4,76	3/16	5	791.018.00
15,8	5/8	6,35	1/4	5	791.009.00
16		5		5	791.006.00
16		8		5	791.025.00
19	3/4	4,76	3/16	7,5	791.019.00
19		6		6	791.007.00
19	3/4	6,35	1/4	7	791.004.00
19		8		6	791.034.00
19	3/4	12,7	1/2	4	791.011.00
22		8		6	791.012.00
22		8		7	791.005.00
22,2	7/8	4,76	3/16	7,5	791.017.00
22,2	7/8	9,52	3/8	7	791.021.00
22,2	7/8	12,7	1/2	7	791.013.00
24		8		8	791.036.00
28		12		8	791.026.00
28,5	1-1/8	4,76	3/16	8,4	791.014.00
28,5	1-1/8	8		8,5	791.030.00
28,5	1-1/8	12,7	1/2	8	791.027.00
31,7	1-1/4	8		5	791.033.00
31,7	1-1/4	12,7	1/2	8	791.015.00
34,9	1-3/8	4,76	3/16	11,5	791.016.00
34,9	1-3/8	8		11,6	791.031.00
34,9	1-3/8	12,7	1/2	11	791.029.00
37		12		12	791.028.00
38,1	1-1/2	12,7	1/2	13,3	791.020.00
62		30		16	791.051.00
62		35		14	791.052.00
80		40		18	791.054.00
80		50		16	791.053.00
10° Delrin® conical bearings					
19	3/4	4,76	3/16	6,8	791.041.00*
Delrin® triangular bearings					
12,7	1/2	4,76	3/16	5,8	791.042.00**
19	3/4	4,76	3/16	7	791.043.00**
Delrin® cylindrical bearings					
12,7	1/2	4,76	3/16	5	791.044.00***
15,87	5/8	4,76	3/16	7,2	791.045.00***
19,05	3/4	4,76	3/16	6,8	791.046.00***
37,4		12,7	1/2	15,7	791.047.00***

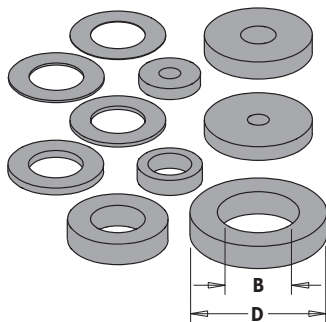

Shields for assembly

B	D	Thickness	ORDER NO.	B	D	Thickness	ORDER NO.
mm	mm	mm		mm	mm	mm	
3,25	9	1,6	541.550.00	8	14,7	5,8	541.519.00
3,25	15,8	2	541.552.00	12	20	2	541.512.00
5,2	15,8	2,5	541.551.00	12	20	3	541.511.00
6,4	9,52	2,2	541.514.00	12	21	0,1	541.513.00
8	14	0,1	541.515.00	12	21	0,3	541.520.00
8	14	0,3	541.516.00	12	21	1,59	541.521.00
8	14	0,5	541.517.00	12	21	3,18	541.522.00
8	14	1	541.518.00	12	21	6,16	541.523.00
8	14,7	3	541.500.00	12	21	1	541.524.00
8	14,7	4	541.501.00	12	21	0,5	541.525.00

Spare part and accessories

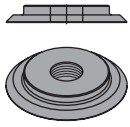

Threaded rings for 694.001 cutter heads

695.996

DESCRIPTION	ORDER NO.
M4 (Ø10x1,6mm)	695.996.01
M4 (Ø12x1,7mm)	695.996.02

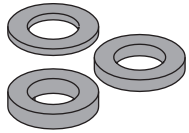

A SPACER SETS

Spacers set

695.998

DESCRIPTION	FOR CUTTER HEAD	ORDER NO.	DESCRIPTION	FOR CUTTER HEAD	ORDER NO.
Ø50x9x30mm	694.015	695.998.01	Ø60x33x40mm	694.005	695.998.14
Ø50x9x31,75mm	694.015	695.998.02	Ø70x22x50mm	694.005	695.998.15
Ø55x9x35mm	694.015	695.998.03	...Pin Hole		
Ø60x9x40mm	694.015	695.998.04	Ø65x8x30mm	694.001 & 694.015	695.998.21
Ø70x9x50mm	694.015	695.998.05	Ø65x8x31,75mm	694.001 & 694.015	695.998.22
Ø50x33x30mm	694.005	695.998.11	Ø65x8x35mm	694.001 & 694.015	695.998.23
Ø50x33x31,75mm	694.005	695.998.12	Ø70x8x40mm	694.001 & 694.015	695.998.24N
Ø55x33x35mm	694.005	695.998.13	Ø70x8x50mm	694.001 & 694.015	695.998.25N

B SPACER SETS WITH PIN HOLE

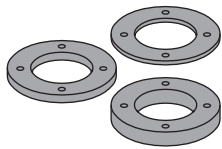

Wedges for cutter heads

651-692-693-695

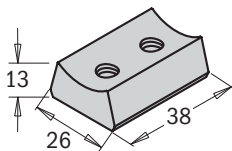
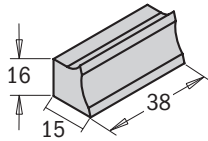

DESCRIPTION	ORDER NO.	DESCRIPTION	ORDER NO.
Wedge for cutter heads			
31x11x9,5mm	695.999.31	38x15x16mm	692.999.01
38x11x9,5mm	695.999.38	38x22,5x13mm	692.999.02
38x11x9,5mm	695.999.39	38x26x13mm	693.999.01
38x11x9,5mm	695.999.41	38x28x12,5mm	693.999.02
38x11x9,5mm	695.999.42	38x15x16mm (per/para 695.018)	695.018.01
38x11x9,5mm	695.999.46	7x11x9,5mm	695.999.07
38x11x9,5mm	695.999.49	16x11x9,5mm	695.999.16
38x11x9,5mm	695.999.53	17x11x9,5mm	695.999.17
Wedges for router bits with knives		22x11x9,5mm	695.999.22
D=8x20mm	651.999.01	23x11x9,5mm	695.999.23
D=10-12-12,7x30mm	651.999.02	23x11x9,5mm	695.999.24
D=12-12,7x50mm	651.999.03		

Slot cutter arbors

7/8/924

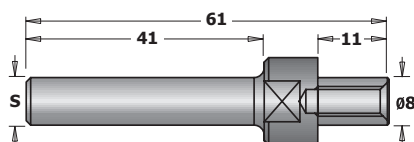
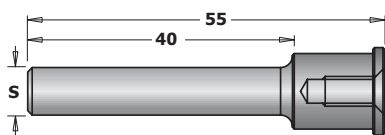
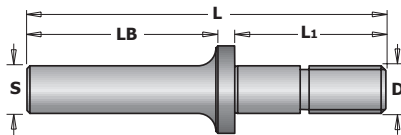

D mm	L1 mm	LB mm	L mm	ORDER NO. S=Ø6mm	ORDER NO. S=Ø6,35mm	ORDER NO. S=Ø8mm	ORDER NO. S=Ø12mm	ORDER NO. S=Ø12,7mm
Arbors for 822 slot cutters								
M8	26	32	61	724.060.00	824.064.00	924.080.00		
M8	40	38	86			924.083.00		
M8	26	38	67,5				924.120.00	824.127.00
M8	40	38	81				924.128.00	824.128.00
M12	54	38	97				924.129.00	824.129.00
M8	47	38	97				924.130.00	824.130.00
M8	29,75	32	71				924.131.00	824.131.00
M8	35,5	28,5	71				924.132.00	824.132.00
M8	23	41	71				924.133.00	824.133.00
M12	39,5	38	85				924.134.00	824.134.00
M12	54,5	38	100					824.135.00
Arbors for 823 slot cutters with counterbore								
		40	55	724.061.00	824.061.00	924.081.00		824.121.00
8	11	41	61	724.062.00	824.062.00	924.082.00		824.122.00

Saw blades
Jig saw blades
Tools with bore & Knives
Router bits & sets
CNC router cutter & chucks
Industrial dowel drills
Bits for hand power tools
Power tools & accessories
Display cabinets & spare parts

Alphabetical index

DESCRIPTION	PAGE	DESCRIPTION	PAGE
1 piece rail & stile cutter heads	67	Cap nuts for router machines	196
1000W router	270	Cavetto edge mold bits	148
12 piece router bit set with wooden case	179	Chamfer bits	143-144
13 piece dovetail and straight bit sets	178	Chamfer bits with insert knives	143
13 piece multiprofile cutter head sets without limiters	71	Chamfer set	144
13 piece router bit set with wooden case	179	Chucks and "ER20" collets for spindle moulder machine	87
15° dovetail cutter with insert knives for roof-frames	138	Chucks for "ER32" precision collets	192
2 flute dowel drills	236-237	Clamping nuts	194, 197
2 flute dowel drills for through holes	242-243	Clamping nuts for chucks with "ER32" collets	192
2 piece adjustable grooving sets	55	Clamping nuts for chucks with "ER40" precision collets	193
2 piece adjustable rounding & chamfering sets	57	Classical bead bits	152
2-piece entry door router bit set	181	Classical ogee bits	154
2400W router	271	CMT Inlay kit	281
3 in 1 flush trim bits for MDF/laminate	116	CMT Molding system	159
3 piece adjustable grooving sets	54	CMT Professional router table system	273
3D Router Carver™ system	282-284	CMT-Enlock joining system	279
4 flute dowel drills	238-239	CMT's complete kitchen set	184
4 flute dowel drills	240	Collet chucks clamp with MK2 tapered shank	197
4 flute dowel drills for through holes	243	Collets for 123 chucks	197
4-wing cut out slot cutters for solid surface	174	Combination trimmer bits	112-113
45° chamfer cutter heads	58	Complete set for decorating and engraving	215
45° countersink with parallel shank	268	Complete set for MDF doors	216
45° lock miter cutter heads	65	Complete set for MDF doors insert knives for optional profiles	217
5 piece boring bit set for hinges	254	Conical scoring blades industrial line	21
5 piece boring bit set for hinges	255	Contractor saw blade masterpack	30
5 piece spiral bit sets	183	Corner beading bit with 45° chamfer	157
5 piece straight bit set and profile bit set	182	Corner beading bits	158
5%co HS spiral bits for aluminium positive single flute	105	Countersinks for 2 flutes dowel drills	244
5%co HS spiral bits for aluminium positive single flute for high cutting depth	105	Countersinks for 4 flutes dowel drills	244
6 piece mortising bit sets	220	Countersinks with threaded shank	266
6 piece mortising bit sets	221	Cove bit set	147
6 piece profile bit set with wooden case	180	Cove bits	147
60° Lettering bit	139	Crosscut saw blades for portable machines	31
7 piece multiprofile cutter head sets with limiters	72	Cutter arbor with HSK tapered shank	196
8 piece dovetail and straight bit sets	178	Cutter arbor with ISO30 tapered shank	196
9° Dovetail cutters	138	Cutter heads for rabbeting and 40mm profile knives	53
90° countersink with parallel shank	268	Cutter heads with limiters	70
		Cutter heads without limiters	70
A		D	
Adaptors	226-228, 252-253	Dado & Planer bits	109
Adaptors for twist drills	234	Decorative ogee bits	151-153
Additional templates, bits and accessories	277	Diamond router cutters with 20° shear angle	208
Adjustable chamfer cutter heads with positive stop	59	Diamond router cutters with 40° shear angle for roughing	209
Adjustable chamfering CNC cutter	214	Diamond router cutters with 45° shear angle	207
Adjustable countersink	266	Diamond whetstones	292-293
Adjustable double roundover router bits	156	Digital angle finder	296
Adjustable roundover and bevel router bits	156	Digital angle gauge	296
Adjustable scoring blades industrial line	21	Digital height gauge	297
Adjustable shaker router bit sets	188	DIN6388 precision collets	194
Adjustable tongue & groove bit set for mission style cabinet doors	188	Display cabinets for router bits / cutter heads / Forstner bits	300
		Display cabinets for router bits /cutter heads / drill bits	298
B		Display cabinets for saw blades	301
Back-to-Back connectors for straight edge clamps (optional)	274	Divided light door sets	187
Balance blade & sanding disks	35	Double-bearing spiral flush trim bits	116
Ball milling	146	Double-edge trimmer	288
Bead & Bull nose bits	158	Dovetail bits	136-137
Beading bits	149	Dowel drills	232
Biscuit joiner saw blades	34	Dowel drills for Mafell® and hand-held routers	263
Blank knives and limiters (to be sharpened)	87	Dowel drills for through holes	233
Blum, Salice, Häfele & Hettich Hinges Boring Head	288	Dowel drills for through holes with countersink	241
Boring bit and plug cutter sets	259	Dowel drills with countersink	241
Boring bits with parallel shank	254-257	Dowel drills with threaded shank	247
Bowl & tray system	295	Dowel drills with threaded shank with countersink	248-249
Bowl and tray bits	139	Dowel drills with threaded shank without countersink	248-249
Brad point bit sets	264	DP conical scoring blades XTreme line	19
Brad point bits	262, 264-265	DP Flush trim bits for laminates	115
Bushings for twist drills	235	DP Hinge boring bits	245
		DP laminated and chipboard saw blades XTreme line	19
C		DP router cutters with shear angle	206-208
C-spanner	197	DP saw blades for ultra-hard materials	29
C-Spanner for "DIN6388" & "ER40"	194	DP spiral router cutters with shear angle	209
C-Spanner for "ER32" precision collets	192	Drawer lock bits	131
C-spanner for "ER40" precision collets	193	Drill bits for ANUBA® hinges	265
Cap nuts for CNC machines	196		

Saw blades
Jig saw blades
Tools with bore & Knives
Router bits & sets
CNC router cutter & chucks
Industrial dowel drills
Bits for hand power tools
Power tools & accessories
Display cabinets & spare parts

Alphabetical index

DESCRIPTION	PAGE	DESCRIPTION	PAGE
Drill bits with 45° countersink set	267	Lock miter bits	129
Drill bits with 90° countersink set	267	Lock miter set	128
Dry cutter saw blades	24	Lockset bits	219
E		Low noise & Chrome coated saw blades with ATB grind	14
Edge Banding bits set	135	Low noise & Chrome coated saw blades with TCG grind	17
Edge-fluting bits	159	Lubricant for wood, neutralizes resin	289
Ellipse & circle cutting jig	278	M	
Entry & interior door router bit set	180	Melamine and laminated long-lasting saw blades XTreme line	17
ER20 precision collets for 796.122/142/162 items	87	Mini-spot circular saw blade for Lamello	35
F		Molding bits	161-162
FILE-FREE Flush trim bits for laminate	117	Mortise chisel & bit sets	257
Fine cut-off saw blades for melamine two-sided XTreme line	16	Mortising bits	108
Fine cut-off saw blades for portable machines	32	Multi-rip anti-kickback saw blades industrial line	9
Fine cut-off saw blades for two-sided melamine industrial line	15-16	Multi-rip saw blades with rakers industrial line	9
Finger joint bit	134	Multiprofile bits	160
Finger pull bit	163	Multiradius roundover cutter heads	60-61
Finishing saw blades industrial line	13	N	
Flexible templates for curved and arched routing	294	Non-ferrous metal and laminated panel saw blades industrial line	23
Flooring router bits	124	Non-ferrous metal and plastic material saw blades industrial line	22
Flush trim bit set	114	O	
Flush trim bits	114	Ogee bits	155
Flush trim bits with insert knives	117	Ogee with fillet bits	155
Flush trim router bits with double bearing	118	Organizer	284
Flute & bead set	128	Ovolo bits	148
Formula 2050: blade and bit cleaner	289	Ovolo sash bits	133
Forstner bit sets	260	P	
Forstner bits	260	Pair of bore reducers	87
G		Panelign strips	184
Glass panel retainers	187	Panel pilot bits with guide	119
Glass panel sets	187	Panel sizing saw blades industrial line	20
Grand rabbeting bits with insert knives	122	Pattern bits	110
Grinding wheels for XTreme sharpening	231	Pattern router bits with insert knives	111
Grooving saw blades industrial line	34	Pattern router bits with insert knives for laminates	111
H		Pattern/Flush trim bits with insert knives	118
Hinge boring bits	245-246	Planner and jointer knives	89-90
Hinge boring bits with chipbreaker for boring machines	246	Planing and jointing spiral cutter heads	56
Hinge recesser bits	109	Plug cutters	258
HS corrugated back moulder knives	88	Plunge ogee bits	153
HSK chuck for "DIN6388" precision collet	194	Plywood groove set	100
HSK chuck for "ER32" precision collets	190	Pocket-Pro™ joinery system	285
HSK chucks for "ER40" precision collets	193	Precision chucks and collets	190
HWM reversible knives	92-93	Precision collets	195
HWM reversible knives for portable planers	91	Precision dado	33
I		Professional adjustable chamfer cutter heads with gear box	59
Industrial chrome-coated scoring blades	22	Professional finger joint bit	134
Industrial XTreme saw blades for stainless steel	24	Professional finger joint cutter heads	63
Industrio routing system	272	Professional raised panel cutter heads	66
Interchangeable boring bits with threaded shank	253	Professional straight edge clamps	274
ISO30 chucks for "ER32" precision collets	191	Profile and counter profile cutter head sets	68-69
ISO30 chucks for "ER40" precision collets	193	Profile knives and limiters	73-86
ISO30 retaining studs	196	PVC & plexiglass saw blades Industrial line	25
ITK Plus crosscut saw blades	27	R	
ITK Plus fine cut-off saw blades	27	Rabbeting bits	121
ITK Plus rip and crosscut saw blades	26	Rabbeting bits with insert knives	122
ITK Plus ripping saw blades	26	Rabbeting cutter heads	52
J		Rabbeting sets	121
Jig saw blades for wood	45~50	Rail & stile sets	168
Junior ogee rail and stile set	167	Rail and stile set	167
K		Raised panel bit with back cutter	165
Keyhole bits	123	Raised panel bits	166
Kitchen sets	185	Reciprocating slot mortising bits	222-224
Kitchen worktop jig	280	Reduction rings for saw blades	35
L		Reverse glue joint bits	130
Laminated and chipboard saw blades industrial line	18	Reverse glue joint cutter heads	64
Laminated and chipboard saw blades XTreme line	18	Rip & crosscut saw blades industrial line	12
Laser point bit (60°) Z=3	141	Rip saw blades for portable machines	29
List of items included in display cabinets	299	Rip saw blades industrial line	11
		Roman ogee bits	154
		Rosette cutters	261

Alphabetical index

DESCRIPTION	PAGE	DESCRIPTION	PAGE
Round nose bits	145	Special dowel drills	250
Round nose set	146	Spiral bits with insert knives and chip-breaker for locksets	205
Round nose solid carbide upcut spiral bits	206	Spoilboard surfacing router cutters with insert knives	213
Roundover and cove cutter heads	62	Step-by-step window sash construction	132
Roundover bits	150	Stepped rebate router bit	142
Roundover bits with insert knives	149	Stile & panel router bits	170
Roundover set	150	Stop collars with Delrin® sleeve	267
Router bit set with insert knives	183	Straight bits	100
Router bit sets	177	Straight bits with centre tip	103
Router bits for Domino® Joining machines by Festool®	263	Straight bits, long series	102
Router cutters	210~212	Straight bits, short series	101
		Straight cutters with threaded shank	104
S		Straight router bits with insert knives	106-107
Saw blade arbor with parallel shank	197	Straight router bits with insert knives for laminates	106
Saw blade index	38~44	Straight router cutters with insert knives	213
Saw blades for building contractors	11	Super fine finishing blade XTreme line	15
Saw blades for building contractors for portable machines	28	Super finishing saw blades for cutting frames XTreme line	13
Saw blades for portable machines	36-37	Super-duty flush trim bits	115
Saw blades stabilizers	35	Superjaws portable clamping system	275
Screw slot bits	124		
Set of 2 magnetic knife setting jigs	88	T	
Sharp technology with a new twist	198	T-Slot bits	123
Slot and mortise boring bits	218	Table edge and hand rail bits	164
Slot cutter sets	182	Tenon cutting router bits	181
Slot cutters	126-127	The ABC's of panel door construction	169
Slot mortising bits	224	The cabinetmaking sets	186
Slot mortising bits with chip-breaker	220	The CMT grand rabbet set	120
Small arch door sets	186	The raised panel sets with backcutter	185
Solid carbide dowel drills	230	Thick-kerf multi-rip saw blades with rakers industrial line	10
Solid carbide dowel drills for through holes	231	Three wing slot cutter set	125
Solid carbide downcut spiral bits	203	Tongue and groove set	125
Solid carbide downcut spiral bits with chip-breaker	200	Twisted slot mortising bits with chip-breaker	221
Solid carbide router cutters	210-211		
Solid carbide spiral bits	98-99	U	
Solid carbide spiral bits downcut	201	Ultra thin-kerf saw blades for cordless saws	28, 30
Solid carbide twist drills "V" point 120° sharpening	235	Universal assembly supports for chucks	190
Solid carbide twist drills negatively ground spurs sharpening	235	Universal boring jig	291
Solid carbide up & downcut spiral bits	199	Universal boring template	290
Solid carbide upcut spiral bits	198-202	Universal dovetail jig	276
Solid carbide upcut spiral bits for locksets	204	Universal hinges boring system	286-287
Solid carbide upcut spiral bits with chip-breaker	200	Upcut spiral bits with chipbreaker for glue-laminated wooden beams	205
Solid carbide upcut with spiral bits chip-breaker for 60° V-point locksets	204		
Solid surface - inlay bits	176	V	
Solid surface bevel bit	173	V-groove - folding - signmaking CNC router cutters with insert knives	214
Solid surface bevel bowl bits	173	V-grooving & signmaking router bits with indexable knives (90°)	142
Solid surface cut and plug repair set	174	V-Grooving bits (90°)	140
Solid surface decorative edge profile bits	171	V-Grooving bits for Alucobond®	141
Solid surface drainboard bits	176	V-Tongue and groove set	135
Solid surface no-drip bit	175	Vertical raised panel bits	164
Solid surface rounding over bits	171		
Solid surface rounding over bowl bit (ogee profile)	172	W	
Solid surface rounding over bowl bits	172	Wainscot/paneling bits	157
Solid surface saw blades industrial line	25	Weatherseal bits	112
Solid surface wavy joint bit	175	Window sash set	132
Spare part and accessories	302-306	Window sill and finger bits	163
Spare parts for chucks	196		

Numerical index

ORDER NO.	PAGE	ORDER NO.	PAGE	ORDER NO.	PAGE	ORDER NO.	PAGE	ORDER NO.	PAGE
01.02	231	105	222	160	221	174	103, 210	183.210	191
03.00.0002	300	106	224	161	221	175	212	183.211	193
03.00.0030	301	107	224	163	218	176	212	183.220	191
03.00.0032	298	112	211	164	218	177	103, 212	183.221	193
03.00.0038	301	113	211	166	219	180	104	183.250	191
03.51	284	123	197	167	219	181	104	183.251	191
03.53.0010	298	124	197	169	219	182	104	183.260	196
03.53.0011 ...	298, 300-301	140	207	170	104	183	190	183.300	190
03.53.0017	298	141	206	171	104	183.000	192	183.310	193
102	220	142	208	172	220	183.100	192	183.320	194
103	223	143	209	173	104	183.200	191	183.360	196
104	222	145	209	173	223	183.201	193	183.400	192

Numerical index

ORDER NO.	PAGE	ORDER NO.	PAGE	ORDER NO.	PAGE	ORDER NO.	PAGE	ORDER NO.	PAGE
183.410.....	197	299.....	35	375.....	243	692.....	70-71	744.....	154
184.....	87	299.10.....	35	376.....	241	693.....	70, 72	746.....	155
184.000.....	195	299.11.....	35	377.....	241	694.001.....	54	747.....	155
184.002.....	195	301.....	226	378.....	241	694.002.....	58	748.....	153
184.xxx.11.....	195	302.....	226	380.....	263	694.003.....	60	748B.....	153
184.xxx.16.....	195	303.....	226	381.....	243	694.004.....	61	749.....	139
184.xxx.20.....	195	304.....	226	392.....	257	694.005.....	57	750.001.....	123
184.xxx.25.....	195	305.....	226	500.001.08.....	259	694.007.....	62	751.....	139
185.....	194	306.....	238	500.002.08.....	259	694.008.....	63	751B.....	139
188.....	105	307.....	238	500.003.08.....	259	694.009.....	64	753.....	119
189.....	105	308.....	239	501.....	254	694.011.....	65	754.....	154, 158
190.....	98, 199	309.....	239	503.....	253	694.013.....	66	755.002.....	131
190B.....	116	310.....	236	506.....	252	694.014.....	67	758.....	141
191.....	99, 183, 202	310.21/22.....	230	509.....	252	694.015.....	68-69	759.....	155
191.143.....	204	310.41/42.....	232	511.....	252	694.017.....	59	760.....	155
191.163.....	204	311.....	237	512.....	255-256	694.018.....	59	761.....	158
191.635.....	112	311.21/22.....	230	513.....	256	694.019.....	56	762.....	159
191B.....	116	311.41/42.....	232	514.....	256	694.020.....	53	763.....	148
192.....	99, 183, 203	312.....	263	515.....	265, 268	694.021.....	55	764.....	148
192B.....	116	313.....	242	515A.....	267	694.022.....	55	765.....	151~153
193.....	201	313.41/42.....	233	516.....	265	694.100.....	52	765B.....	152
194.....	201	314.....	242	517.....	264	699.....	87	790.....	91~93
195.....	200, 204-205	314.21/22.....	231	521.....	268	700.001.....	177	792.....	89
195.143.....	204	314.41/42.....	233	521.001.....	266	700.003.....	177	793.....	88
195.163.....	204	315.....	244	521A.....	267	700.005.03.....	182	795.....	90
196.....	200	316.....	244	522.....	138	700.084.00.....	300	796.....	87
197.....	199	317.....	245	523.....	138	700.300.00L.....	298-299	800.001.....	177
198.....	98, 198	317C.....	246	529.....	258	701.....	108	800.005.01.....	182
199.....	145, 206	325.....	249	530.....	258	701B.....	108	800.500.....	178
210.....	16	327.....	249	531.....	261	702.....	109	800.501.....	178
222.....	25	329.....	249	532.....	252	703.....	143	800.503.....	179
223.....	25	330.....	249	533.....	252	704.....	143	800.504.....	180
226.....	24, 24	332.....	248	534.....	253	705.....	143	800.505.....	179
230.....	33	334.....	248	535.....	262	706.....	114-115	800.506.....	125
236.....	29	336.....	248	537.....	260	707.....	113, 116	800.509.....	184
237.....	19	337.....	248	537.000.04.....	260	709.....	113	800.510.....	184
238.....	19	338.....	249	537.000.05.....	260	710.....	113	800.511.....	184
240.....	34	339.....	249	537.000.07.....	260	711.....	100-101	800.512.....	185
240.004.04.....	35	340.....	249	537.000.12.....	260	711.031.....	112	800.513.....	185
241.....	34	341.....	248	537.000.16.....	260	711B.....	110	800.514.....	185
250.....	28	342.....	248	540.....	262	712.....	102	800.515.....	186
251.....	28	343.....	248	541.....	262, 267	712.030.....	112	800.516.....	185
271.....	26, 28	344.....	247	542.....	262	712.040.....	112	800.517.....	185
272.....	27-28	346.....	247	543.....	257	712B.....	110	800.518.....	185
273.....	27	350.....	266	600.005.01.....	183	713.001.....	112	800.519.....	178
274.....	15	351.....	266	615.004.01.....	216-217	714.....	145	800.520.....	186
277.....	10	352.....	247	626.000.01.....	215	714B.....	145	800.521.....	185
278.....	9	353.....	247	651.....	106	715.....	140	800.522.....	185
279.....	9	358.....	226	652.....	106	715B.....	140	800.524.....	186
280.....	10	359.....	226	652B.....	111	716.....	119	800.525.....	187
281.....	17-18, 20, 32	360.001.....	226	653.....	107	716.061.....	119	800.527.....	180
282.....	20	360.101.....	228	653.....	213	718.....	136-137	800.606.....	134
283.....	16	360.201.....	228	654.....	107	718B.....	136-137	800.616.....	134
284.....	22	360.301.....	228	655.....	107	721.....	112	800.622.....	156
285.....	11-14, 31-32	360.401.....	228	656.....	111	722A.....	126	800.623.....	156
285.5.....	13	361.....	236	657.1.....	117	724.....	127	800.624.....	188
286.....	11	362.....	237	657B.....	118	724.xxx.00.....	126	800.625.....	188
287.....	15	363.....	235	659.....	143	724.xxx.10.....	126	800.626.....	125
288.....	21-22	364.....	234	660.....	122	727.....	148	800.627.....	181
289.....	21-22	365.....	234	660.9.....	122	735.....	121	800.628.....	181
290.....	11, 29	366.....	242	661.....	149	735.001.....	121	801.....	108
291.....	12, 31	367.....	243	662.....	205	736.....	144	801B.....	108
292.....	32	368.....	243	663.....	213	737.....	147	806.....	114-115
293.....	11	369.....	245-246	663.001.11.....	214	738.....	150	806B.....	118
294.....	12-13	369C.....	246	663.101.11.....	214	739.....	149	807.....	113, 116-117
295.....	17	370.....	246	664.....	138	740.....	154	809.....	113
296.....	23	372.....	240	665.....	142	741.....	154	811.....	100-101
297.....	23	373.....	240	690-691.....	73-86	742.....	113	811B.....	110
298.....	30	374.....	243	690-691.....	87	743.....	113	812.....	102

Numerical index



ORDER NO.	PAGE	ORDER NO.	PAGE	ORDER NO.	PAGE	ORDER NO.	PAGE	ORDER NO.	PAGE
812.032.....	112	855.805.....	163	900.512.....	185	951.....	139	991.123.....	197
812B.....	110	855.805B.....	163	900.513.....	185	953.....	119	991.183.....	192
813.....	124	855.806.....	181	900.514.....	185	954.....	157-158	991.184.....	193
813.001.....	112	855.901.....	161	900.516.....	185	955.....	128, 163	991.283.....	194
814.....	145-146	855.902.....	161	900.517.....	185	955.002.....	131	991.5.....	168
814B.....	145	856.501.....	161	900.518.....	185	955.008.....	131	991.512.....	167
815.....	140	856.601.....	164	900.521.....	185	955.3.....	133	991.517.....	167
815B.....	140	856.701.....	164	900.522.....	185	955.302.....	133	991.521.....	168
816.....	119	856.702.....	164	900.527.....	180	955.501.....	130	992.123.....	197
818.....	136-137	856.8.....	160	900.606.....	134	955.502.....	131	992.183.....	192
818B.....	136-137	856.851.....	159	900.616.....	134	955.503.....	129	992.283.....	194
821.....	112	856.852.....	159	900.622.....	156	955.504.....	129	992.383.....	193
822.....	126	857.....	144	900.623.....	156	955.506.....	135	992.5.....	196
822.023B.....	124	858.....	141	900.624.....	188	955.510.....	135	993.0.....	196
822.024B.....	124	859.....	155	900.625.....	188	955.701.....	128	993.5.....	196
822.033B.....	174	860.....	155	900.626.....	125	955.801.....	132	998.....	289
822A.....	126	861.....	158	900.627.....	181	955.803.....	187	999.100.00.....	273
822B.....	126	861.6.....	157	900.628.....	181	955.804.....	163	999.500.01.....	272
823.....	127	862.....	159	901.....	108	955.804B.....	163	BTS-002.....	295
823.001.....	182	863.....	148	901B.....	108	955.805.....	163	CMT-Enlock1.....	279
823B.....	127	864.....	148	902.....	109	955.805B.....	163	CMT200.....	275
824.....	127	865.....	151-153	903.....	143	955.806.....	181	CMT300.....	276-277
824.xxx.00.....	126	865B.....	152	904.....	143	955.901.....	161	CMT3000.....	278
824.xxx.10.....	126	866.501.....	172	905.....	143	955.902.....	161	CMT333.....	286-287
827.....	148	866.601.....	171	906.....	114-115	956.501.....	161	CMT334.....	288
835.....	121	866.602.....	171	906B.....	118	956.601.....	164	CMT650.....	280
835.001.....	121	867.5B.....	162	907.....	117	956.701.....	164	CMT656.....	291
835.503.....	120	867.6B.....	162	909.....	113, 116	956.8.....	160	CMT792.....	88
836.....	144	868.....	146	910.....	113	956.851.....	159	CMT7E.....	271
837.....	147	870.....	169	911.....	100-101	956.852.....	159	CMT8E.....	270
838.....	150	880.5.....	166	911B.....	110	957.....	144	CMT900.....	290
839.....	149	880.501.....	170	912.....	102	958.....	141	DAF-001.....	296
840.....	154	880.502.....	170	912B.....	110	959.....	155	DAG-001.....	296
841.....	154	880.503.....	170	913.....	124	959.702.....	164	DET-001.....	288
842.....	113	880.504.....	170	914.....	145	960.....	155	DHG-001.....	297
843.....	113	880.511.....	176	914B.....	145	961.....	158	DSS.....	292-293
844.....	154	880.512.....	176	915.....	140-141	961.6.....	157	GLAS/RTBRN.....	187
845.....	154	880.513.....	176	915B.....	140	963.....	148	JT101AO.....	48
846.....	155	880.521.....	170	916.....	119	964.....	148	JT101B.....	48
847.....	155	880.531.....	175	918.....	136-137	965.....	142, 151-153	JT101BIF.....	49
848.....	153	880.541.....	171	921.....	112	965B.....	152	JT101BR.....	48
848B.....	153	880.542.....	171	922.033B.....	174	966.501.....	172	JT101D.....	49
849.....	139	880.551.....	172	922A.....	126	966.601.....	171	JT111C.....	47
849B.....	139	881.501.....	175	922B.....	126	966.602.....	171	JT118A.....	50
850.001.....	123	881.511.....	176	923.001.....	182	967.5B.....	162	JT118B.....	50
850.6.....	123	881.512.....	176	923A.....	127	967.6B.....	162	JT119B0.....	47
851.....	139	881.521.....	173	924.....	127	968.....	146	JT123X.....	50
851B.....	139	881.531.....	175	924.xxx.00.....	126	970.....	169	JT127D.....	50
852.....	109	881.541.....	174	924.xxx.10.....	126	980.501.....	170	JT144D.....	47
852B.....	109	890.....	165	927.....	148	980.502.....	170	JT218A.....	50
853.....	119	890.6.....	164	935.....	121	980.503.....	170	JT234X.....	49
854.....	158	891.5.....	168	935.001.....	121	980.504.....	170	JT244D.....	47
855.....	128	891.512.....	167	935.503.....	120	980.511.....	176	JT301CD.....	49
855.....	163	891.517.....	167	936.....	144	980.512.....	176	JT344D.....	48
855.002.....	131	891.521.....	168	937.....	147	980.513.....	176	K (Contractor).....	30
855.3.....	133	899.....	281	938.....	150	980.521.....	170	PGC.....	274
855.501.....	130	900.001.....	177	939.....	149	980.531.....	175	PNL-001.....	184
855.502.....	131	900.003.....	177	940.....	154	980.541.....	171	PPJ-002.....	285
855.503.....	129	900.005.01.....	182	941.....	154	980.542.....	171	RCS.....	282-284
855.504.....	129	900.005.03.....	182	944.....	154	980.551.....	173	TMP.....	294
855.506.....	135	900.021.00.....	298-299	945.....	154	981.501.....	175		
855.508.....	131	900.024.....	186	946.....	155	981.511.....	176		
855.510.....	135	900.025.....	187	947.....	155	981.512.....	176		
855.701.....	128	900.084.00.....	300	948.....	153	981.521.....	173		
855.801.....	132	900.300.00L.....	298-299	948B.....	153	981.531.....	175		
855.802.....	133	900.506.....	125	949.....	139	981.541.....	174		
855.803.....	187	900.509.....	184	949B.....	139	990.....	165		
855.804.....	163	900.510.....	184	950.001.....	123	990.5.....	166		
855.804B.....	163	900.511.....	184	950.6.....	123	990.6.....	164		

Conversion Table

Inch Decimals	Inch Fractions (x)						Millimeters					
	1/64	1/32	1/16	1/8	1/4	1/2	mm	1" + (x)	2" + (x)	3" + (x)	4" + (x)	5" + (x)
0.015625	1/64						0.397	25.400	50.800	76.200	101.600	127.000
0.031250		1/32					0.794	25.797	51.197	76.597	101.997	127.397
0.046875	3/64						1.191	26.194	51.595	76.994	102.394	127.794
0.062500			1/16				1.588	26.591	51.991	77.391	102.791	128.191
0.078125	5/64						1.984	26.988	52.388	77.788	103.188	128.588
0.093750		3/32					2.381	27.384	52.784	78.184	103.584	128.984
0.109375	7/64						2.778	27.781	53.181	78.581	103.981	129.381
0.125000				1/8			3.175	28.178	53.578	78.978	104.378	129.778
0.140625	9/64						3.572	28.575	53.975	79.375	104.775	130.175
0.156250		5/32					3.969	28.972	54.372	79.772	105.172	130.572
0.171875	11/64						4.366	29.369	54.769	80.169	105.569	130.969
0.187500			3/16				4.762	29.766	55.166	80.568	105.966	131.366
0.203125	13/64						5.159	30.162	55.562	80.962	106.362	131.762
0.218750		7/32					5.556	30.559	55.959	81.359	106.759	132.159
0.234375	15/64						5.953	30.956	56.356	81.756	107.156	132.556
0.250000					1/4		6.350	31.353	56.753	82.153	107.553	132.953
0.265625	17/64						6.747	31.750	57.150	82.550	107.950	133.350
0.281250		9/32					7.144	32.147	57.547	82.947	108.347	133.747
0.296875	19/64						7.541	32.544	57.944	83.344	108.744	134.144
0.312500			5/16				7.938	32.941	58.341	83.741	109.141	134.541
0.328125	21/64						8.334	33.338	58.738	84.138	109.538	134.938
0.343750		11/32					8.731	33.734	59.134	84.534	109.934	135.334
0.359375	23/64						9.128	34.131	59.531	84.931	110.331	135.731
0.375000				3/8			9.526	34.528	59.928	85.328	110.728	136.128
0.390625	25/64						9.922	34.925	60.325	85.725	111.125	136.525
0.406250		13/32					10.319	35.322	60.722	86.122	111.522	136.922
0.421875	27/64						10.716	35.719	61.119	86.519	111.919	137.319
0.437500			7/16				11.112	36.116	61.516	86.916	112.316	137.716
0.453125	29/64						11.509	36.513	61.913	87.313	112.713	138.113
0.468750		15/32					11.906	36.909	62.309	87.709	113.109	138.509
0.484375	31/64						12.303	37.306	62.706	88.106	113.506	138.906
0.500000					1/2		12.700	37.703	63.103	88.503	113.903	139.303
0.515625	33/64						13.097	38.100	63.500	88.900	114.300	139.700
0.531250		17/32					13.494	38.497	63.897	89.297	114.697	140.097
0.546875	35/64						13.891	38.894	64.294	89.694	115.094	140.494
0.562500			9/16				14.288	39.291	64.691	90.091	115.491	140.891
0.578125	37/64						14.684	39.688	65.088	90.488	115.888	141.288
0.593750		19/32					15.081	40.084	65.484	90.884	116.284	141.684
0.609375	39/64						15.478	40.481	65.881	91.281	116.681	142.081
0.625000				5/8			15.875	40.878	66.278	91.678	117.078	142.478
0.640625	41/64						16.272	41.275	66.675	92.075	117.475	142.875
0.656250		21/32					16.669	41.672	67.072	92.472	117.872	143.272
0.671875	43/64						17.066	42.069	67.469	92.869	118.269	143.669
0.687500			11/16				17.462	42.466	67.866	93.266	118.666	144.066
0.703125	45/64						17.859	42.862	68.262	93.662	119.062	144.462
0.718750		23/32					18.256	43.259	68.659	94.059	119.459	144.859
0.734375	47/64						18.653	43.656	69.056	94.456	119.856	145.256
0.750000					3/4		19.050	44.053	69.453	94.853	120.253	145.653
0.765625	49/64						19.447	44.450	69.850	95.250	120.650	146.050
0.781250		25/32					19.844	44.847	70.247	95.647	121.047	146.447
0.796875	51/64						20.241	45.244	70.644	96.044	121.444	146.844
0.812500			13/16				20.638	45.641	71.041	96.441	121.841	147.241
0.828125	53/64						21.034	46.038	71.438	96.838	122.238	147.638
0.843750		27/32					21.431	46.434	71.834	97.234	122.634	148.034
0.859375	55/64						21.828	46.831	72.231	97.631	123.031	148.431
0.875000				7/8			22.225	47.228	72.628	98.028	123.428	148.828
0.890625	57/64						22.622	47.625	73.025	98.425	123.825	149.225
0.906250		29/32					23.019	48.022	73.422	98.822	124.222	149.622
0.921875	59/64						23.416	48.419	73.819	99.219	124.619	150.019
0.937500			15/16				23.812	48.816	74.216	99.616	125.016	150.416
0.953125	61/64						24.209	49.212	74.612	100.012	125.412	150.812
0.968750		31/32					24.606	49.609	75.009	100.409	125.809	151.209
0.984375	63/64						25.003	50.000	75.406	100.806	126.206	151.606
								50.403	75.803	101.203	126.603	152.003

Saw blade safety

- ALWAYS** thoroughly check all blades for damage and flaws before using. Do not use blades with missing or damaged teeth.
- ALWAYS** wear safety glasses and ear protection when using power tools.
- ALWAYS** thoroughly read the owners manual and manufacturer's instructions before working with tools.
- ALWAYS** use a fence and splitter when using the table saw. Do not make freehand cuts.
- ALWAYS** use pusher blocks or a pusher stick, especially when working with small or narrow pieces.
- ALWAYS** unplug your saw before cleaning or adjusting the tool, or before making blade changes.
- ALWAYS** keep your tools sharpened, clean and stored in a safe place to avoid breakage and accidents and to extend the life of your bits and blades.
- ALWAYS** feed the work against the rotation of the blade on table saws.
- ALWAYS** be sure your workpiece is completely supported, before and after the cut.
- NEVER** remove guards from radial arm saws and miter saws.
- NEVER** remove the splitter or anti-kickback devices from table saws.
- NEVER** use dull or damaged blades.
- NEVER** use blades with missing or chipped teeth.
- NEVER** force the cut or overload the saw.
- NEVER** change blades with the saw plugged in.
- NEVER** make adjustments to any saw while the blade is turning.

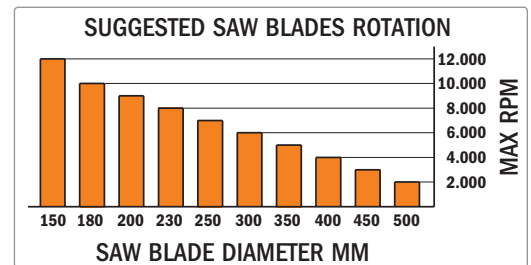

Cutter head safety

- ALWAYS** thoroughly check all cutters for damage and flaws before using.
- ALWAYS** wear safety glasses and ear protection when using power tools.
- ALWAYS** thoroughly read the owners manual and manufacturer's instructions before working with tools.
- ALWAYS** use guards that were supplied with your shaper.
- ALWAYS** use a fence with your shaper. Do not make freehand cuts.
- ALWAYS** use pusher blocks, especially when working with small or narrow pieces.
- ALWAYS** unplug your shaper before cleaning or adjusting the tool, or before making cutter or knife changes.
- ALWAYS** be sure the spindle nut is tight before plugging in the shaper.
- ALWAYS** check that knives are properly and securely installed in the cutterhead when using interchangeable-knife systems.
- ALWAYS** keep your tools sharpened, clean and stored in a safe place to avoid breakage and accidents and to extend the life of your bits and blades.
- ALWAYS** feed the work against the rotation of the knives.
- ALWAYS** be sure your workpiece is completely supported, before and after the cut.
- NEVER** remove guards or any other safety devices from your shaper.
- NEVER** use dull or damaged knives.
- NEVER** force the cut or overload the shaper.
- NEVER** change cutters or knives or make adjustments with the shaper plugged in.
- NEVER** make adjustments to the shaper while the cutter is turning.

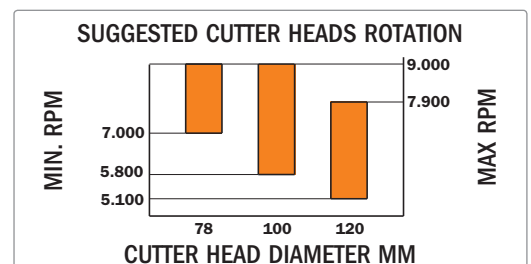





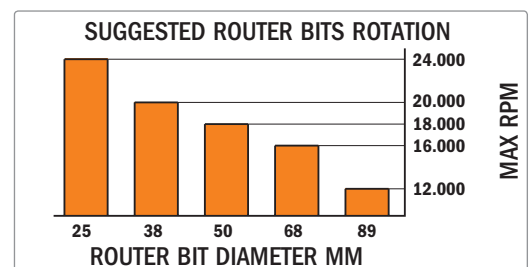

















































Router bits safety

- ALWAYS** thoroughly check all tools for possible flaws before using.
- ALWAYS** wear safety glasses and ear protection.
- ALWAYS** thoroughly read the owners manual and manufacturer instructions before using.
- ALWAYS** check that at least 75% of the shank is securely inserted into the collet of the router.
- ALWAYS** use template guide collars when possible to absorb lateral bit deflection.
- ALWAYS** use a fence when working on the router table.
- ALWAYS** reduce the router speed when working with larger diameter bits.
- ALWAYS** keep your fence adjusted so there is some clearance between the bearing guide and the workpiece.
- ALWAYS** take care to remove large quantities of stock (cross section > 10mm) in more than one run.
- ALWAYS** keep your tools sharpened, clean and stored in a safe place to avoid breakage and accidents and to extend the life of your bits and blades.
- NEVER** use dull or defective, even suspiciously defective, tools.
- NEVER** force the shank entirely into the collet (bottoming out). Leave about a 3,2mm (1/8") space from the bottom.
- NEVER** force the bit into your router or overload the router.



Explanation of symbol

	Antikick-back		Radial relief		Tool with plunging capacity		Tool with bearing
	Not for hand held use for router table only		Low noise saw blade		Tungsten carbide tipped		Solid tungsten carbide
	High speed steel		Alloyed tools steel		High-alloyed tool steel		High performance steel
	High carbon steel		Bimetal		High speed steel		Cermet Carbide
	Polycrystalline diamond		Insert carbide		Polycrystalline diamond		One cutting edge
	One + one cutting edges		Two cutting edges		Two + one cutting edges		Two + two cutting edges
	Three cutting edges		Three + three cutting edges		Three cutting edges with chipbreaker		Four cutting edges
	Twelve cutting edges		One spur		Two spur		Four spur
	Right-hand rotation		Left-hand rotation		Right-hand & Left-hand rotation		Mechanical feed
	Manual feed		Cardboard box for saw blades		Plastic carry case for saw blades		
	Clamshell carry case for saw blades		Plastic box for cutter head		Wear dust mask		Wear safety helmet
	Wear safety glasses		Wear safety shoes		Wear five finger gloves		Wear ear protection
	Warning		Industrial Thin-kerf blade		ORANGE CHROME		High-Density Carbide
	High performance tool		Non-Stick Orange Shield Coating™		Shear Angle Grind		

Conditions of trading

PREMISE

C.M.T. products are the result of technological innovation achieved through continuous research applied on a vast scale. Drawings, technical data, photos of the products and packaging are supplied for the sole purpose of informing the customer and are not binding in any manner. **C.M.T.** may undertake, when necessary, modifications and improvements without applying these innovations to the parts already supplied. The operational tolerances conform to technical standards that are acceptable for this range of tools.

ACCEPTANCE OF THE CONTRACT

All orders for our products are meant to be accepted at the price and sale conditions that are legally in force at the date of delivery. Every order will be treated and supplied according to the following general sale conditions. By placing an order or accepting an offer, the customer accepts, without any reservations, all conditions expressly mentioned hereafter. Any other derogation will only be accepted upon written consent by **C.M.T.** All other cases not contained within these conditions will fall under the Italian Civil Code. Offers and order confirmations will be processed according to stock availability. Any order, even those taken by our representative agents, will be subject to our acceptance, which could also be a partial one. We will notify the acceptance of any order by an order confirmation in which we will indicate all details pertaining to the items purchased, their price and expected delivery date. Therefore, we will not be able to accept any modification after three working days from the date of receipt.

MINIMUM AMOUNT ACCEPTABLE

C.M.T. will only be able to accept and process orders for a minimum net amount of € 100,00. In case of acceptance of the order, we will add € 15,00 for shipping and handling.

PRICES

The prices stated in **C.M.T.**'s quotation and price lists are gross and are intended to be "ex-works". Prices and VAT will be those in force at the date of shipping. To the best of our knowledge, the prices indicated in our catalogues, price lists and order confirmations are correct. However, **C.M.T.** cannot be held legally liable for reserving the right to change prices without notification in line with the manufacturer's cost increases.

DELIVERY

Delivery dates in the order confirmation are given as an indication of the estimated delivery time. They have to be considered as reliable only in case of normal operating conditions, and there shall be no liability on the part of the Seller for any failure to deliver due to causes beyond the Seller's control. **C.M.T.** will also not be able to accept any cancellation of existing orders which were not delivered in time due to external impediments. Standard products will be shipped within five working days from receipt of the order.

SHIPPING AND HANDLING

The packing of our products will be charged on the final invoice, while shipping is "ex-works" from our factory at Chiusa di Ginestreto (Pesaro). All products supplied by **C.M.T.** travel at the customer's own risk. **C.M.T.** retains the right to charge freight costs on the invoice in case of value under the minimum amount acceptable of €100,00. **C.M.T.** will not be held responsible for any damage, theft or tampering that might occur during transport, and for which the forwarder will be legally liable according to article 1693 of the Civil Code. The customer, for his part, will have to check the goods at the moment of receipt and, in case any anomaly or damage is found, he will have to apply for a refund to be addressed to the forwarder.

PAYMENT

Cash payments can only be accepted for purchases done directly at the **C.M.T.** factory located in Chiusa di Ginestreto (Pesaro) in accordance with article 1182, sub-section 3 of the Civil Code, or upon delivery of the goods provided there is a written agreement between the parties. Deferred methods of payment will have to be previously agreed with the Seller. In this case, if one or more instalments are not paid, the agreement will automatically expire according to article 1186 of the Civil Code. A delay in payment, even partial, will automatically incur interest in the amount of an extra 5% to be charged to the customer's account. In case of non payment, **C.M.T.** reserves the right to suspend any further supply of its products.

WARRANTY

All professional tools by **C.M.T.** are manufactured according to high standards of technology and are therefore warranted against any possible defect. This warranty does not cover damage or tampering which can be ascribed to inappropriate use. It is also not applicable for tools that have been re-sharpened. This warranty does not cover the possible injuries resulting from inappropriate use of defective tools. **C.M.T.** will repair or replace any goods which the buyer shall prove to have been defective in material or workmanship upon analysis by its technical department. Any complaint must be communicated within fifteen days from receipt of the goods together with a written form in which the customer provides a detailed description of the defect. Any return of tools will only be accepted upon authorisation by **C.M.T.** and the freight will be at the customer's own expense.

OWNERSHIP RIGHTS

All rights are reserved in accordance with Italian law and with international agreements, and the whole or any part of this catalogue may not be reproduced in any way or form.

PLACE OF JURISDICTION

For any legal matter the place of jurisdiction is Pesaro. All contracts, even those made with foreign Buyers or for goods to be sent abroad, are regulated by Italian legislation.

CMT ORANGE TOOLS™

C.M.T. UTENSILI S.p.A.

Via della Meccanica
61122 Pesaro - Fraz. Chiusa di Ginestreto - Italia

Tel. #39 0721 48571
Fax #39 0721 481021
e-mail info@cmtutensili.com

www.cmtutensili.com

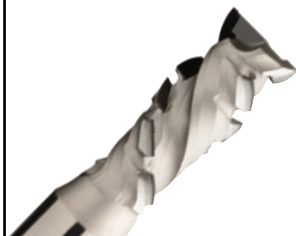

ORDER NO. 03.60.3006

